



Yavuz Pano Aydınlatma endüstriyel tesislerden, kamu hizmetlerine, sanayiden, ulaşım, konut projelerinden, enerji sektörüne kadar birçok alanda hizmet vermektedir.

# AYDINLATMA

2024 FİYAT LİSTESİ

**Yavuz Pano Aydınlatma** 1989 yılında Türk endüstrisine AG enerji sistemlerinde kullanılmak üzere pano üreterek ticari hayatına başlamıştır. Uzun süren bu yolculuk esnasında YAVUZ küçük bir işletmeden ulusal ve uluslararası pazarda güveni ve kaliteyi simgeleyen bir marka olmuştur. Bugün hali hazırda 20.000 m<sup>2</sup>'nin üzerinde kapalı üretim alanı, ileri teknoloji makine parkuru ve 200'ün üzerinde nitelikli personel istihdamı mevcuttur.

Yavuz Pano Aydınlatma endüstriyel tesislerden, kamu hizmetlerine, sanayiden, ulaşıma, konut projelerinden, enerji sektörüne kadar birçok alanda hizmet vermektedir. Projelerde malzeme seçimleri, bakır hesaplamaları, lumen ölçümleri, lux ölçümleri gibi bir çok konuda mühendislik desteği sağlamaktadır. Müşteri memnuniyetini en temel görevi olarak benimsemiş ve bu doğrultuda faaliyetlerini sürdürmeye devam etmektedir. PVC Kablo Kanalı üretiminde de var olarak günden güne çeşitliliğini arttırmaktadır. Ayrıca Solar Aydınlatma Sistemlerinde de projelere ürün tedariki sağlayıp, gerekli mühendislik hizmetleri de sunmaktadır.

Türkiye'de Alçak Gerilim Panolarında uluslararası standartlar da (IEC) ve Avrupa Normlarına (EN) uygun olarak son teknoloji makine parkuru ile yüksek teknoloji ürünleri üretmeyi hedeflemiş olan Yavuz Pano Aydınlatma 2012 yılından itibaren Endüstriyel Aydınlatma ve LED Aydınlatma Sistemleri alanında yapmış olduğu önemli yatırımla Türkiye de %100 yerli sermaye ve yerli imalatla LED Aydınlatma Armatürleri üretimi yapan önemli birkaç firma arasında yer almaktadır.

**YAVUZ** started its commercial life in 1989 by producing panels for the Turkish industry in LV energy systems. During this long journey, Yavuz has been a brand that represents a trust and quality in a national and international market from a small business. At present, there are over 20.000 m<sup>2</sup> closed production area, advanced technology machinery park and more than 200 qualified personnel.

YAVUZ keeps servicing for various types of business fields such as industrial facilities, institutions, housing projects, energy etc. has become leader of the sector by providing service worldwide. Providing engineering service such as material selection, copper calculation, lumen measurement, lux calculations. Embraced the customer satisfaction as the main function and continues to pursue its activities within this direction. Manufacturing PVC Cable Trays and its diversity day by day. Also supplies products to projects in Solar Lighting Systems and provides engineering services.

Have been manufacturing LV Electrical Panels with International Standards (IEC) and European Norms (EN) since 1989 with high technology machinery line and also manufacturing LED Lightings since 2012 with huge product range. With these investments, continues to be one of the biggest manufacturers in Turkey.



## LED AYDINLATMA LED LIGHTING

	MIRANDA	8		PALLAS	10		MIMOZA	12		ARDIÇ	14		MERCAN	16		GÜMÜŞ	18		GÜMÜŞ S2	20		GÜMÜŞ S2 PRO	22
	SAFİR	24		SAFİR S2	26		TARU APRON	28		VEGA	30		COMFORT	32		MİTRA	34		VESTA	36		VENÜS	38
	VENÜS PRO	40		İRİS S2	42		KUZGUN	44		LUPALED	46		AKASYA ALM	48		AKASYA PC	50		BEGONYA	52		LADEN	54
	LADEN SA	56		LADEN MINI	58		LED BAR	60		RİGEL	62		NİRRİTİ	64		ARUNA	66		RİO	68		RİO SÜ	70
	MİA	72		TOFİ	74		REPLAY	76		REPLAY SÜ	78		PERLA	80		PERLA SÜ	82		PERLA STERİL	84		ALREP	86
	ALREP STERİL	88		MANOLYA	90		MANOLYA	92		MONA	94		FİKUS SPOT	96		YUKA SPOT	98		FULYA	100		PROTON	102
	PUNTO	102		PUNTO	102		MİRA APLİK	102		MİRA V2 APLİK	102		ARTEMİS	102		AKSESUARLAR	103		EXIT	104		EXIT	105
	EXIT	105																					

## SOLAR AYDINLATMA SOLAR LIGHTING

	APOLLON	108		RA	110
--	---------	-----	--	----	-----

## EX-PROOF AYDINLATMA EX-PROOF LIGHTING

	ETNA	114		HELENS	116		FUJİ - PROJKTÖR	118		FUJİ - Y.TAVAN	118		FUJİ - KANOPI	118
--	------	-----	--	--------	-----	--	-----------------	-----	--	----------------	-----	--	---------------	-----

## KLASİK AYDINLATMA CLASSIC LIGHTING

	KAMLEYA T8	122		KAMELYA T5	124		MEYAN POLİMER	126		MEYAN ALM	128		SEMEN	130		GEVEN	132
--	------------	-----	--	------------	-----	--	---------------	-----	--	-----------	-----	--	-------	-----	--	-------	-----

## POLYESTER PANOLAR POLYESTER ENCLOSURES

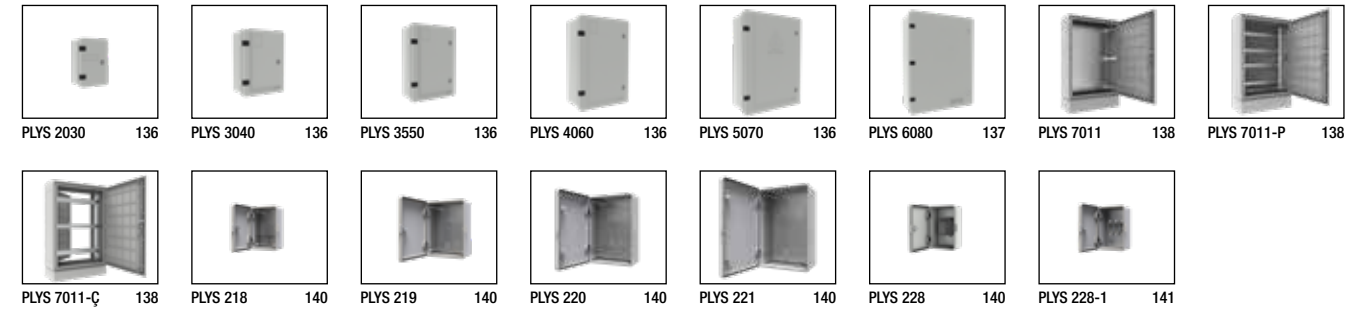

## PLASTİK PANOLAR PLASTIC ENCLOSURES

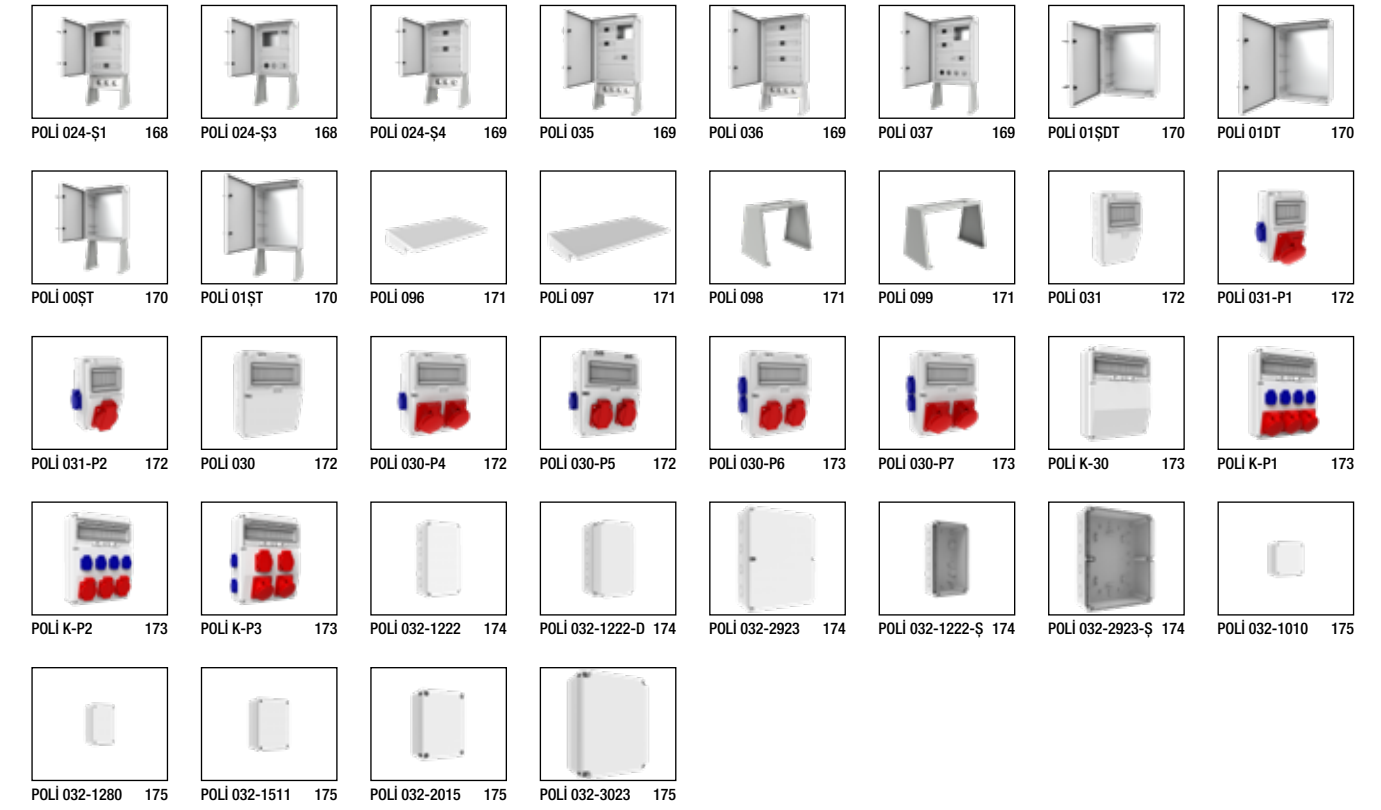

## SAC PANOLAR METAL PANEL BOARD

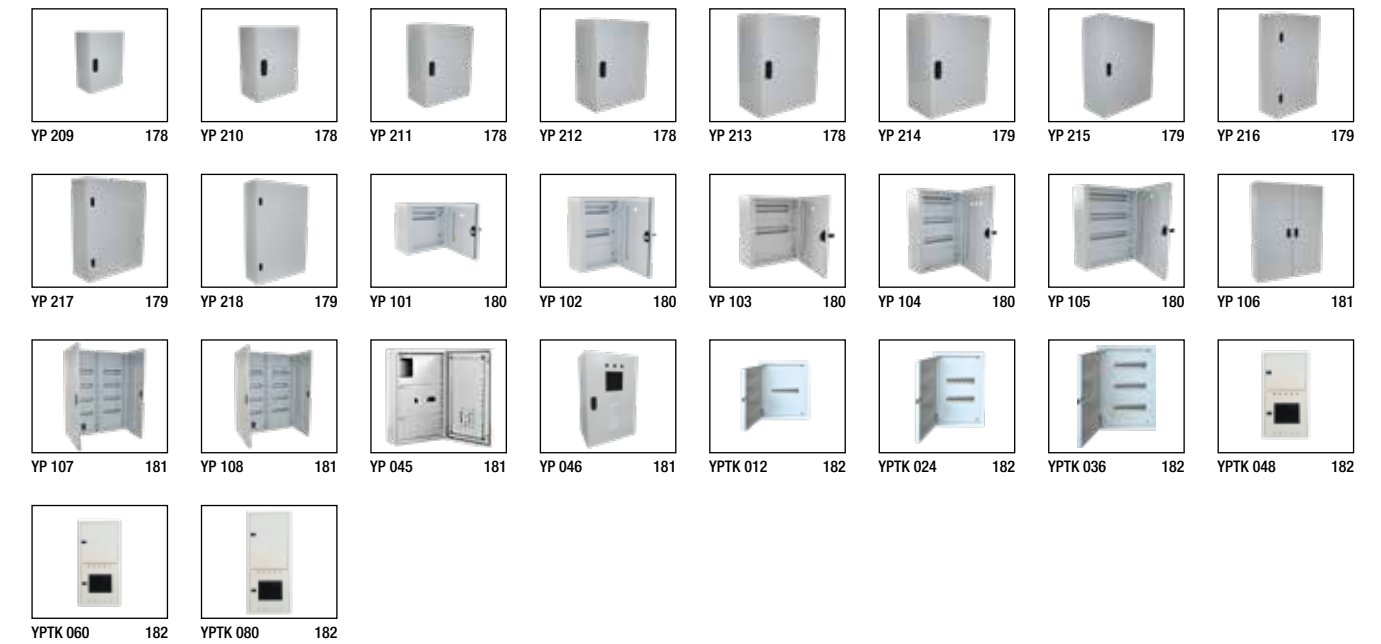

# LED AYDINLATMA LED LIGHTING

LED Aydınlatma Teknolojisi, enerji tasarruflu aydınlatmada en son teknolojidir. LED 'Işık Yayan Diyot', elektriği ışığa dönüştüren yarı iletken cihaz anlamına gelir. LED aydınlatmanın düşük enerji tüketimi ve uzun ömrü sayesinde geleneksel aydınlatmaya göre çok daha ekonomiktir.

LED Lighting Technology is the latest technology in energy saving lighting. LED 'Light Emitting Diode' means a semiconductor device that converts electricity into light. Thanks to the low energy consumption and long life of LED lighting, it is much more economical than traditional lighting.



**YENİ**

Alüminyum enjeksiyon gövde  
Elektrostatik toz boyalı  
Temperli cam

Aluminium injection body  
Electrostatic powder coated  
Tempered glass

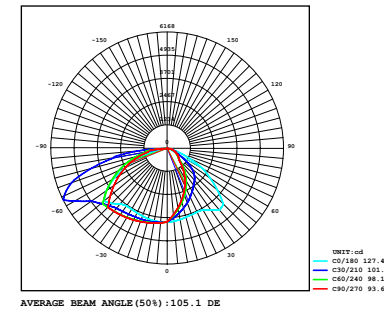

Tedaş Şartnamelerine Uyumlu YENİ Yol ve Cadde Armatürü

**Ürün Özellikleri**

Product Features

IP Koruma Sınıfı / IP Protection Class	: IP 66
Kullanım Şekli / Usage	: Direk Montaj / Pole Mount
Işık Kaynağı / Source of Light	: High Power LED

**Elektriksel Özellikleri**

Electrical Properties

Giriş Gerilimi / Input Voltage	: 220-240 V
Giriş Frekans / Input Frequency	: 50-60 Hz
Max. Gerilim Dayanımı / Max. Voltage Strength	: 10 kV
Sürüş Akımı / Driving Current	: 700 mA
Güç Faktörü / Power Factor	: > 0.95
Renksel Geriverim İndeksi / Color Rendering Index	: > 80

**Diğer Özellikleri**

Other Features

Çalışma Sıcaklık Aralığı / Operating Heat Range	: -20°C / +45°C
Darbe Dayanım (IK) / Impact Resistance	: IK10
Led Ömrü / Led Life	: 100.000 saat / hour

**Renk Sıcaklığı**  
Kelvin



**Opsiyonel Özellikler**

Optional Features

Renk Sıcaklığı / Kelvin	: 3000K - 4000K - 6500K
DALI	: Var / Yes
Sensör / Sensor	: Var / Yes



Kod Code	Güç Power	Işık Akısı Lumen	Verimlilik Efficiency	Fiyat Price (\$)
VL546100	100W	16.717	167.1 lm/w	475.00
VL546120	120W	19.561	163.0 lm/w	485.00
VL546150	150W	23.668	157.7 lm/w	495.00
VL546200	200W	30.145	150.7 lm/w	500.00
VL546250	250W	36.156	144.6 lm/w	515.00

**Ölçüler**

Dimensions (mm)

	a	b	h
Standart	804	298	142

**Konsol**

Console (mm)

Haraketli /Sliding	Ø60
--------------------	-----

**Ağırlık**

Weight (kg)

100W	7,08
120W	7,30
150W	7,30
200W	7,40
250W	7,55

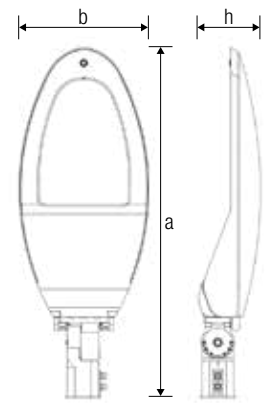



YENİ

Alüminyum enjeksiyon gövde  
Elektrostatik toz boyalı  
Temperli cam

Aluminium injection body  
Electrostatic powder coated  
Tempered glass

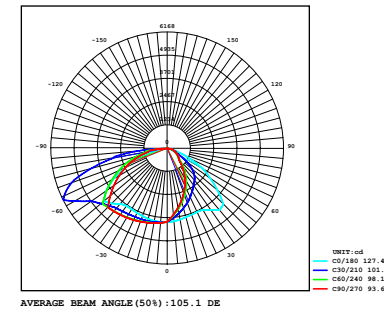

Tedaş Şartnamelerine Uyumlu YENİ Yol ve Cadde Armatürü

#### Ürün Özellikleri

##### Product Features

IP Koruma Sınıfı / IP Protection Class	: IP 66
Kullanım Şekli / Usage	: Direk Montaj / Pole Mount
Işık Kaynağı / Source of Light	: High Power LED

#### Elektriksel Özellikleri

##### Electrical Properties

Giriş Gerilimi / Input Voltage	: 220-240 V
Giriş Frekans / Input Frequency	: 50-60 Hz
Max. Gerilim Dayanımı / Max. Voltage Strength	: 10 kV
Sürüş Akımı / Driving Current	: 700 mA
Güç Faktörü / Power Factor	: > 0.95
Renksel Geriverim İndeksi / Color Rendering Index	: > 80

#### Diğer Özellikleri

##### Other Features

Çalışma Sıcaklık Aralığı / Operating Heat Range	: -20°C / +45°C
Darbe Dayanım (IK) / Impact Resistance	: IK10
Led Ömrü / Led Life	: 100.000 saat / hour

#### Renk Sıcaklığı

Kelvin



#### Opsiyonel Özellikler

##### Optional Features

Renk Sıcaklığı / Kelvin	: 3000K - 4000K - 6500K
DALI	: Var / Yes
Sensör / Sensor	: Var / Yes



Kod Code	Güç Power	Işık Akısı Lumen	Verimlilik Efficiency	Fiyat Price (\$)
-------------	--------------	---------------------	--------------------------	---------------------

VL547030	30W	5.493	183.1 lm/w	420.00
VL547045	45W	7.783	172.9 lm/w	430.00
VL547060	60W	9.912	165.2 lm/w	440.00
VL547080	80W	11.997	149.9 lm/w	450.00

#### Ölçüler

##### Dimensions (mm)

Standart	a	b	h
----------	---	---	---

Standart	607	280	116
----------	-----	-----	-----

#### Konsol

##### Console (mm)

Haraketli /Sliding	Ø77
--------------------	-----

#### Ağırlık

##### Weight (kg)

30W	4,51
45W	4,53
60W	4,55
80W	4,57

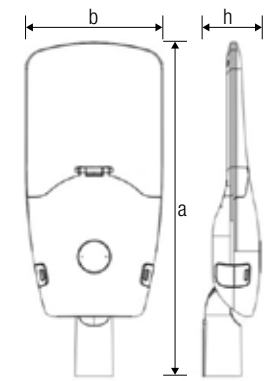



Alüminyum enjeksiyon gövde  
Elektrostatik toz boyalı  
Temperli cam

Aluminium injection body  
Electrostatic powder coated  
Tempered glass

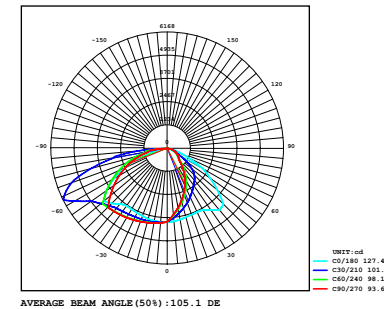

Kod Code	Güç Power	Işık Akısı Lumen	Verimlilik Efficiency	Fiyat Price (\$)
VL548030	30W	3.862	128.7 lm/w	75.00
VL548045	45W	5.317	118.1 lm/w	85.00

Ölçüler Dimensions (mm)	a	b	h	d	Ağırlık Weight (kg)
Standart	378	143	68	40	30W : 1,60 45W : 1,70

Konsol Console (mm)	Sabit / Fixed	Ø40
------------------------	---------------	-----

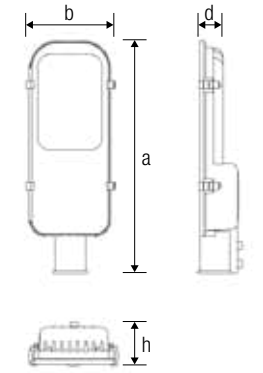

Kod Code	Güç Power	Işık Akısı Lumen	Verimlilik Efficiency	Fiyat Price (\$)
VL548060	60W	8.239	137.3 lm/w	100.00

Ölçüler Dimensions (mm)	a	b	h	d	Ağırlık Weight (kg)
Standart	454	170	75	41	60W : 2,70

Konsol Console (mm)	Sabit / Fixed	Ø50
------------------------	---------------	-----

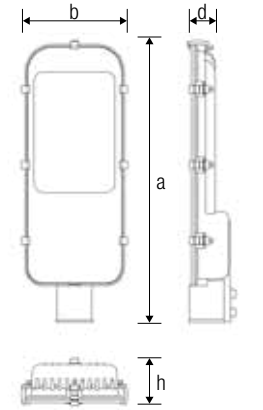

### Ürün Özellikleri

#### Product Features

IP Koruma Sınıfı / IP Protection Class	: IP 66
Kullanım Şekli / Usage	: Direk Montaj / Pole Mount
Işık Kaynağı / Source of Light	: High / Mid Power LED

### Elektriksel Özellikleri

#### Electrical Properties

Giriş Gerilimi / Input Voltage	: 220-240 V
Giriş Frekans / Input Frequency	: 50-60 Hz
Max. Gerilim Dayanımı / Max. Voltage Strength	: 2 kV
Sürüş Akımı / Driving Current	: 700 mA
Güç Faktörü / Power Factor	: > 0.95
Renk Geriverim İndeksi / Color Rendering Index	: > 80

### Renk Sıcaklığı

Kelvin



### Opsiyonel Özellikler

#### Optional Features

Renk Sıcaklığı / Kelvin	: 3000K - 4000K - 6500K
DALI	: Var / Yes
Sensör / Sensor	: Var / Yes



Kod Code	Güç Power	Işık Akısı Lumen	Verimlilik Efficiency	Fiyat Price (\$)
VL548075	75W	11.055	147.4 lm/w	170.00
VL548090	100W	14.192	141.9 lm/w	185.00
VL548120	120W	16.479	137.3 lm/w	190.00
VL548150	150W	19.746	131.6 lm/w	200.00

Ölçüler Dimensions (mm)	a	b	h	d	Ağırlık Weight (kg)
Standart	609	200	80	42	80W : 2,70 100W : 3,50 120W : 4,00 150W : 4,50

Konsol Console (mm)	Haraketli / Sliding	Ø60
------------------------	---------------------	-----

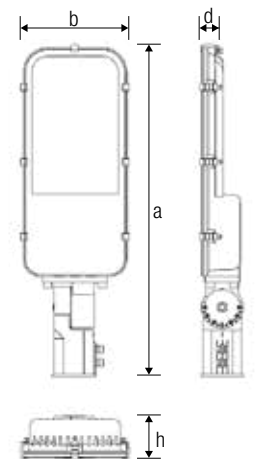





Alüminyum enjeksiyon gövde  
Elektrostatik toz boyalı  
Temperli cam

Aluminium injection body  
Electrostatic powder coated  
Tempered glass

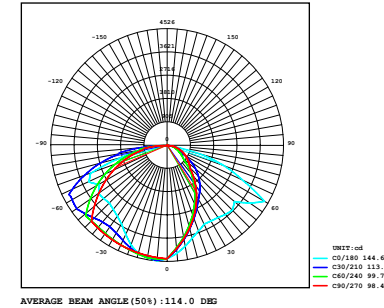

### Ürün Özellikleri

#### Product Features

IP Koruma Sınıfı / IP Protection Class	: IP 67
Kullanım Şekli / Usage	: Direk Montaj / Pole Mount
Işık Kaynağı / Source of Light	: High / Mid Power LED

### Elektriksel Özellikleri

#### Electrical Properties

Giriş Gerilimi / Input Voltage	: 220-240 V
Giriş Frekans / Input Frequency	: 50-60 Hz
Max. Gerilim Dayanımı / Max. Voltage Strength	: 2-10 kV
Sürüş Akımı / Driving Current	: 700 mA
Güç Faktörü / Power Factor	: > 0.95
Renksel Geriverim İndeksi / Color Rendering Index	: > 80

### Diğer Özellikleri

#### Other Features

Çalışma Sıcaklık Aralığı / Operating Heat Range	: -20°C / +45°C
Darbe Dayanım (IK) / Impact Resistance	: IK10
Led Ömrü / Led Life	: 60.000 saat / hour

### Renk Sıcaklığı

Kelvin



### Opsiyonel Özellikler

#### Optional Features

Renk Sıcaklığı / Kelvin	: 3000K - 4000K - 6500K
DALI	: Var / Yes
Sensör / Sensor	: Var / Yes



Kod Code	Güç Power	Işık Akısı Lumen	Verimlilik Efficiency	Fiyat Price (\$)
VL548045-A	45W	6.350	141.1 lm/w	190.00
VL548060-A	60W	8.139	135.6 lm/w	205.00
VL548075-A	80W	10.316	128.9 lm/w	210.00
VL548090-A	100W	12.318	123.1 lm/w	220.00
VL548120-A	120W	14.416	120.1 lm/w	300.00
VL548150-A	150W	18.025	120.1 lm/w	305.00
VL548180-A	180W	21.600	120.0 lm/w	315.00
VL548200-A	200W	24.627	123.1 lm/w	325.00

### Ölçüler

#### Dimensions (mm)

Standart	a	b	h
	532	288	80

### Konsol

#### Console (mm)

Haraketli /Sliding	Ø60
--------------------	-----

### Ağırlık

#### Weight (kg)

45W	6,20
60W	6,29
80W	6,30
100W	6,31
120W-150W	6,90
180W-200W	7,00

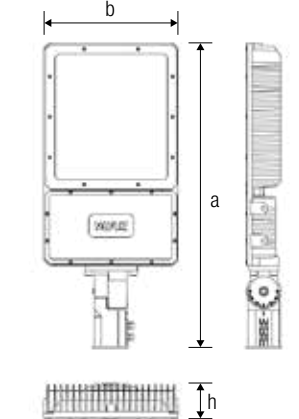
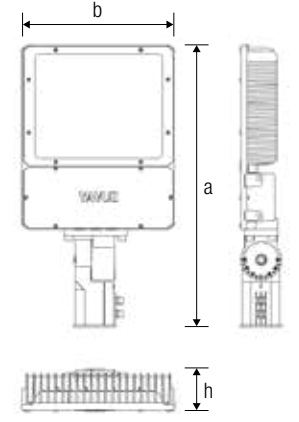

Kod Code	Güç Power	Işık Akısı Lumen	Verimlilik Efficiency	Fiyat Price (\$)
VL548250-A	250W	30.045	120.1 lm/w	350.00
VL548300-A	300W	36.175	120.5 lm/w	470.00

### Ölçüler

#### Dimensions (mm)

Standart	a	b	h
	676	300	80

### Konsol

#### Console (mm)

Haraketli /Sliding	Ø60
--------------------	-----

### Ağırlık

#### Weight (kg)

250W	9,00
300W	9,70

Kod Code	Güç Power	Işık Akısı Lumen	Verimlilik Efficiency	Fiyat Price (\$)
VL548400-A	400W	59.071	147.6 lm/w	580.00
VL548500-A	500W	70.654	141.1 lm/w	590.00

### Ölçüler

#### Dimensions (mm)

Standart	a	b	h
	676	300	138

### Konsol

#### Console (mm)

Haraketli /Sliding	Ø60
--------------------	-----

### Ağırlık

#### Weight (kg)

400W	11,28
500W	11,28

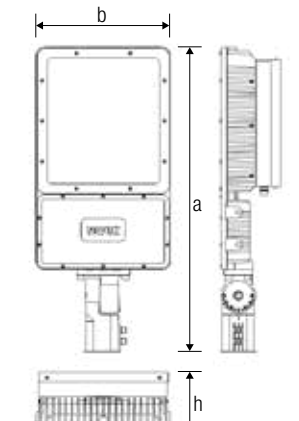



Alüminyum enjeksiyon gövde  
Elektrostatik toz boyalı  
Temperli cam

Aluminium injection body  
Electrostatic powder coated  
Tempered glass

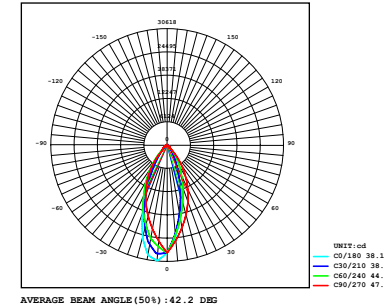

Kod Code	Güç Power	Işık Akısı Lumen	Verimlilik Efficiency	Fiyat Price (\$)
VL508045-M	45W	6.350	141.1 lm/w	190.00
VL508060-M	60W	8.139	135.6 lm/w	205.00
VL508075-M	80W	10.316	128.9 lm/w	210.00
VL508090-M	100W	12.318	123.1 lm/w	220.00
VL508120-M	120W	14.416	120.1 lm/w	300.00
VL508150-M	150W	18.025	120.1 lm/w	305.00
VL508180-M	180W	21.600	120.0 lm/w	315.00
VL508200-M	200W	24.627	123.1 lm/w	325.00

Ölçüler Dimensions (mm)	a	b	h
Standart	480	326	90

Ağırlık Weight (kg)	Fiyat Price (\$)
45W	7,34
60W	7,50
80W	7,51
100W	7,72
120W-150W	7,90
180W-200W	8,00

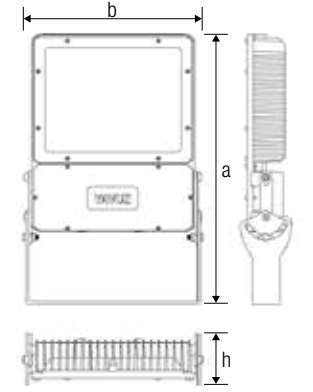

Kod Code	Güç Power	Işık Akısı Lumen	Verimlilik Efficiency	Fiyat Price (\$)
VL508250-M	250W	30.045	120.1 lm/w	350.00
VL508300-M	300W	36.175	120.5 lm/w	470.00

Ölçüler Dimensions (mm)	a	b	h
Standart	587	340	90

Ağırlık Weight (kg)	Fiyat Price (\$)
250W	9,66
300W	10,16

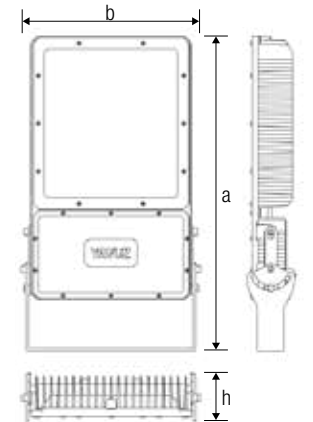

Kod Code	Güç Power	Işık Akısı Lumen	Verimlilik Efficiency	Fiyat Price (\$)
VL508400-M	400W	59.071	147.6 lm/w	580.00
VL508500-M	500W	70.654	141.1 lm/w	590.00

Ölçüler Dimensions (mm)	a	b	h
Standart	587	340	143

Ağırlık Weight (kg)	Fiyat Price (\$)
400W	11,83
500W	11,83

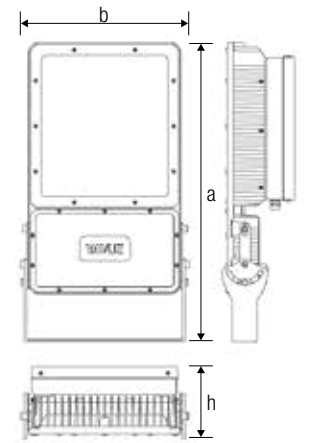

Ürün Özellikleri  
Product Features

IP Koruma Sınıfı / IP Protection Class	: IP 67
Kullanım Şekli / Usage	: Zemin Montaj / Floor Mount
Işık Kaynağı / Source of Light	: High / Mid Power LED

Elektriksel Özellikleri  
Electrical Properties

Giriş Gerilimi / Input Voltage	: 220-240 V
Giriş Frekans / Input Frequency	: 50-60 Hz
Max. Gerilim Dayanımı / Max. Voltage Strength	: 2-10 kV
Sürüş Akımı / Driving Current	: 700 mA
Güç Faktörü / Power Factor	: > 0.95
Renksel Geriverim İndeksi / Color Rendering Index	: > 80

Diğer Özellikleri  
Other Features

Çalışma Sıcaklık Aralığı / Operating Heat Range	: -20°C / +45°C
Darbe Dayanım (IK) / Impact Resistance	: IK10
Led Ömrü / Led Life	: 60.000 saat / hour

Renk Sıcaklığı  
Kelvin



Opsiyonel Özellikler  
Optional Features

Renk Sıcaklığı / Kelvin	: 3000K - 4000K - 6500K
DALI	: Var / Yes
Sensör / Sensor	: Var / Yes





Alüminyum enjeksiyon gövde  
Elektrostatik toz boyalı  
Temperli cam

Aluminium injection body  
Electrostatic powder coated  
Tempered glass

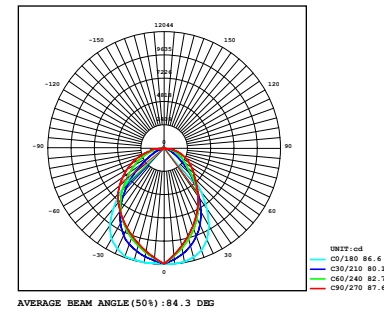

Kod Code	Güç Power	Işık Akısı Lumen	Verimlilik Efficiency	Fiyat Price (\$)
VL508045	45W	5.332	118.4 lm/w	75.00
VL508060	60W	6.696	111.6 lm/w	90.00
VL508075	75W	8.355	111.4 lm/w	95.00

## Ölçüler

Dimensions (mm)

Standart	a	b	h
	335	242	57

## Ağırlık

Weight (kg)

45W	1,90
60W	1,98
75W	1,98

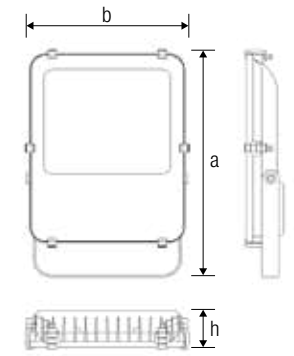

Kod Code	Güç Power	Işık Akısı Lumen	Verimlilik Efficiency	Fiyat Price (\$)
VL508090	100W	11.075	110.7 lm/w	150.00
VL508120	120W	13.425	111.8 lm/w	155.00

## Ölçüler

Dimensions (mm)

Standart	a	b	h
	325	296	80

## Ağırlık

Weight (kg)

100W	3,23
120W	3,23

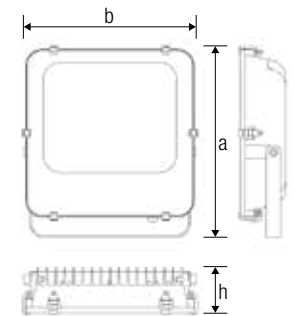

Kod Code	Güç Power	Işık Akısı Lumen	Verimlilik Efficiency	Fiyat Price (\$)
VL508150	150W	17.040	113.6 lm/w	195.00
VL508200	200W	22.375	111.8 lm/w	280.00

## Ölçüler

Dimensions (mm)

Standart	a	b	h
	390	318	82

## Ağırlık

Weight (kg)

150W	4,70
200W	5,25

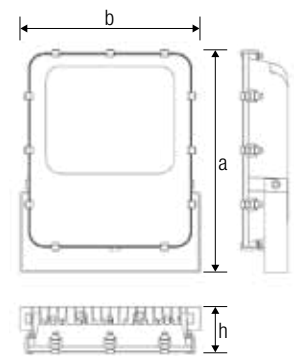

## Ürün Özellikleri

## Product Features

IP Koruma Sınıfı / IP Protection Class	: IP 66
Kullanım Şekli / Usage	: Zemin Montaj / Floor Mount
Işık Kaynağı / Source of Light	: High Power LED

## Elektriksel Özellikleri

## Electrical Properties

Giriş Gerilimi / Input Voltage	: 220-240 V
Giriş Frekans / Input Frequency	: 50-60 Hz
Max. Gerilim Dayanımı / Max. Voltage Strength	: 2-10 kV
Sürüş Akımı / Driving Current	: 700 mA
Güç Faktörü / Power Factor	: > 0.95
Renksel Geriverim İndeksi / Color Rendering Index	: > 80

Renk Sıcaklığı  
Kelvin

## Diğer Özellikleri

## Other Features

Çalışma Sıcaklık Aralığı / Operating Heat Range	: -20°C / +45°C
Darbe Dayanım (IK) / Impact Resistance	: IK10
Led Ömrü / Led Life	: 60.000 saat / hour

## Opsiyonel Özellikler

## Optional Features

Renk Sıcaklığı / Kelvin	: 3000K - 4000K - 6500K
DALI	: Var / Yes
Sensör / Sensor	: Var / Yes



Alüminyum enjeksiyon gövde  
Elektrostatik toz boyalı  
Temperli cam

Aluminium injection body  
Electrostatic powder coated  
Tempered glass

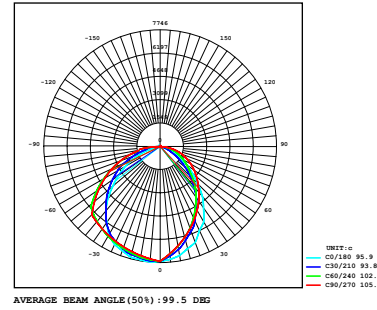

### Ürün Özellikleri

#### Product Features

IP Koruma Sınıfı / IP Protection Class	: IP 66
Kullanım Şekli / Usage	: Zemin Montaj / Floor Mount
Işık Kaynağı / Source of Light	: Mid Power LED

### Elektriksel Özellikleri

#### Electrical Properties

Giriş Gerilimi / Input Voltage	: 220-240 V
Giriş Frekans / Input Frequency	: 50-60 Hz
Max. Gerilim Dayanımı / Max. Voltage Strength	: 10 kV
Sürüş Akımı / Driving Current	: 700 mA
Güç Faktörü / Power Factor	: > 0.95
Renksel Geriverim İndeksi / Color Rendering Index	: > 80

### Diğer Özellikleri

#### Other Features

Çalışma Sıcaklık Aralığı / Operating Heat Range	: -20°C / +45°C
Darbe Dayanım (IK) / Impact Resistance	: IK10
Led Ömrü / Led Life	: 100.000 saat / hour

### Renk Sıcaklığı

Kelvin



### Opsiyonel Özellikler

#### Optional Features

Renk Sıcaklığı / Kelvin	: 3000K - 4000K - 6500K
DALI	: Var / Yes
Sensör / Sensor	: Var / Yes



Kod Code	Güç Power	Işık Akısı Lumen	Verimlilik Efficiency	Fiyat Price (\$)
VL508250	250W	33.719	134.8 lm/w	350.00
VL508300	300W	39.485	131.6 lm/w	450.00
VL508400	400W	49.101	122.7 lm/w	520.00
VL508500	500W	57.865	115.7 lm/w	530.00

### Ölçüler

#### Dimensions (mm)

Standart	a	b	h
Standart	451	476	135

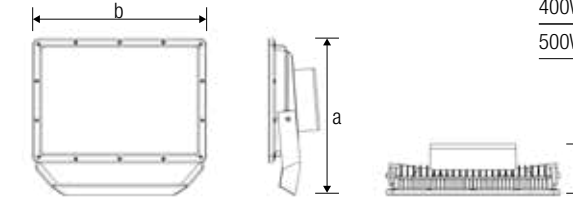

### Ağırlık

#### Weight (kg)

250W	9,50
300W	9,50
400W	9,77
500W	9,77

Kod Code	Güç Power	Işık Akısı Lumen	Verimlilik Efficiency	Fiyat Price (\$)
VL508600	600W	83.195	138.6 lm/w	950.00
VL508700	700W	93.932	134.1 lm/w	1.000.00
VL508800	800W	105.484	131.8 lm/w	1.080.00
VL508900	900W	115.545	128.3 lm/w	1.090.00
VL5081000	1000W	126.335	126.3 lm/w	1.100.00

### Ölçüler

#### Dimensions (mm)

Standart	a	b	h
Standart	468	773	94

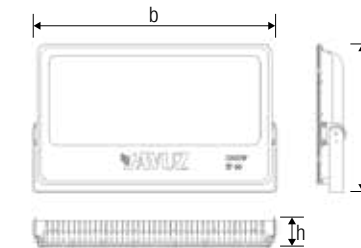

### Ağırlık

#### Weight (kg)

600W	16,72
700W	17,60
800W	18,60
900W	19,60
1000W	20,60



Alüminyum enjeksiyon gövde  
Elektrostatik toz boyalı  
Temperli cam

Aluminium injection body  
Electrostatic powder coated  
Tempered glass

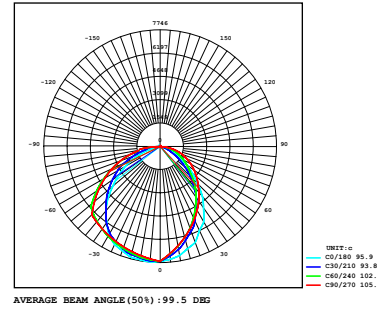

### Ürün Özellikleri

#### Product Features

IP Koruma Sınıfı / IP Protection Class	: IP 66
Kullanım Şekli / Usage	: Zemin Montaj / Floor Mount
Işık Kaynağı / Source of Light	: Mid Power LED
Optik / Optical	: Lens

### Elektriksel Özellikleri

#### Electrical Properties

Giriş Gerilimi / Input Voltage	: 220-240 V
Giriş Frekans / Input Frequency	: 50-60 Hz
Max. Gerilim Dayanımı / Max. Voltage Strength	: 10 kV
Sürüş Akımı / Driving Current	: 700 mA
Güç Faktörü / Power Factor	: > 0.95
Renksel Geriverim İndeksi / Color Rendering Index	: > 80

### Diğer Özellikleri

#### Other Features

Çalışma Sıcaklık Aralığı / Operating Heat Range	: -20°C / +45°C
Darbe Dayanım (IK) / Impact Resistance	: IK10
Led Ömrü / Led Life	: 100.000 saat / hour

### Renk Sıcaklığı

Kelvin



### Opsiyonel Özellikler

#### Optional Features

Renk Sıcaklığı / Kelvin	: 3000K - 4000K - 6500K
DALI	: Var / Yes
Sensör / Sensor	: Var / Yes



Kod Code	Güç Power	Işık Akısı Lumen	Verimlilik Efficiency	Fiyat Price (\$)
VL508250-P	250W	32.570	130.2 lm/w	400.00
VL508300-P	300W	37.750	125.8 lm/w	510.00
VL508400-P	400W	47.427	118.5 lm/w	560.00
VL508500-P	500W	55.892	111.7 lm/w	570.00

### Ölçüler

#### Dimensions (mm)

Standart	a	b	h
Standart	451	476	135

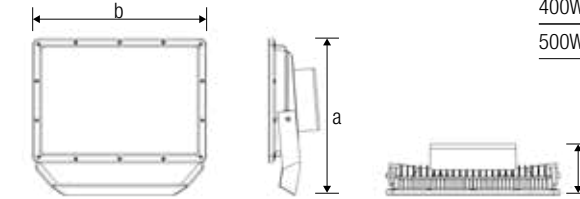

### Ağırlık

#### Weight (kg)

250W	9,50
300W	9,50
400W	9,77
500W	9,77

Kod Code	Güç Power	Işık Akısı Lumen	Verimlilik Efficiency	Fiyat Price (\$)
VL508600-P	600W	80.359	133.9 lm/w	1.050.00
VL508700-P	700W	90.730	129.6 lm/w	1.065.00
VL508800-P	800W	101.888	127.3 lm/w	1.210.00
VL508900-P	900W	112.667	125.1 lm/w	1.220.00
VL5081000-P	1000W	122.047	122.0 lm/w	1.230.00

### Ölçüler

#### Dimensions (mm)

Standart	a	b	h
Standart	468	773	94

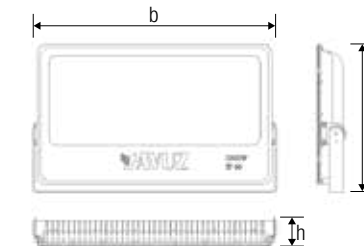

### Ağırlık

#### Weight (kg)

600W	16,72
700W	17,60
800W	18,60
900W	19,60
1000W	20,60



Alüminyum enjeksiyon gövde  
Elektrostatik toz boyalı  
Temperli cam

Aluminium injection body  
Electrostatic powder coated  
Tempered glass

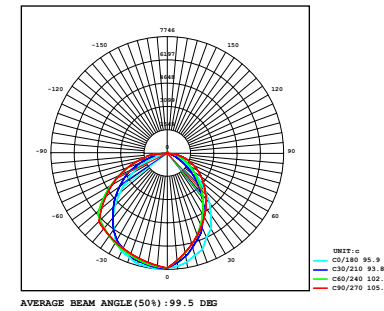

### Ürün Özellikleri

#### Product Features

IP Koruma Sınıfı / IP Protection Class	: IP 65
Kullanım Şekli / Usage	: Zemin Montaj / Floor Mount
Işık Kaynağı / Source of Light	: Mid Power LED

### Elektriksel Özellikleri

#### Electrical Properties

Giriş Gerilimi / Input Voltage	: 220-240 V
Giriş Frekans / Input Frequency	: 50-60 Hz
Max. Gerilim Dayanımı / Max. Voltage Strength	: 2 kV
Sürüş Akımı / Driving Current	: 700 mA
Güç Faktörü / Power Factor	: > 0.9
Renk Geriverim İndeksi / Color Rendering Index	: > 80

### Diğer Özellikleri

#### Other Features

Çalışma Sıcaklık Aralığı / Operating Heat Range	: -20°C / +45°C
Darbe Dayanım (IK) / Impact Resistance	: IK10
Led Ömrü / Led Life	: 100.000 saat / hour

### Renk Sıcaklığı

Kelvin



### Opsiyonel Özellikler

#### Optional Features

Renk Sıcaklığı / Kelvin	: 3000K - 4000K - 6500K
DALI	: Var / Yes
Sensör / Sensor	: Var / Yes



Kod Code	Güç Power	Işık Akısı Lumen	Verimlilik Efficiency	Fiyat Price (\$)
VL519050	50W	6.000	120.0 lm/w	32.00

### Ölçüler

#### Dimensions (mm)

Standart	a	b	h
Standart	205	215	44

### Ağırlık

#### Weight (kg)

50W	0,22
-----	------

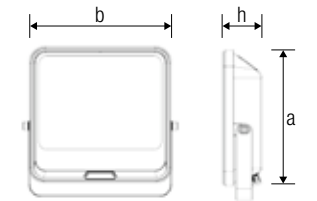

Kod Code	Güç Power	Işık Akısı Lumen	Verimlilik Efficiency	Fiyat Price (\$)
VL519100	100W	12.000	120.0 lm/w	36.00

### Ölçüler

#### Dimensions (mm)

Standart	a	b	h
Standart	235	245	47

### Ağırlık

#### Weight (kg)

100W	0,35
------	------

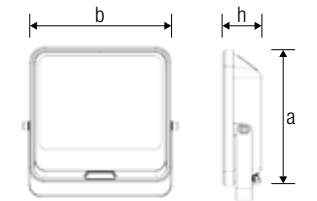

Kod Code	Güç Power	Işık Akısı Lumen	Verimlilik Efficiency	Fiyat Price (\$)
VL519150	150W	18.000	120.0 lm/w	55.00

### Ölçüler

#### Dimensions (mm)

Standart	a	b	h
Standart	275	285	47

### Ağırlık

#### Weight (kg)

150W	0,55
------	------

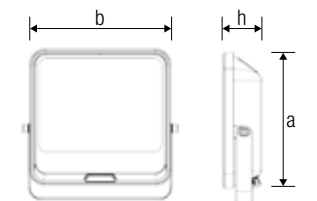

Kod Code	Güç Power	Işık Akısı Lumen	Verimlilik Efficiency	Fiyat Price (\$)
VL519200	200W	24.000	120.0 lm/w	68.00

### Ölçüler

#### Dimensions (mm)

Standart	a	b	h
Standart	316	326	47

### Ağırlık

#### Weight (kg)

200W	0,68
------	------

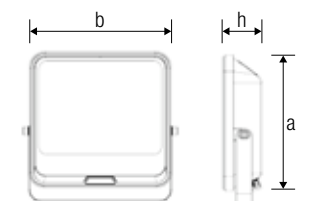

Kod Code	Güç Power	Işık Akısı Lumen	Verimlilik Efficiency	Fiyat Price (\$)
VL519300	300W	36.000	120.0 lm/w	100.00

### Ölçüler

#### Dimensions (mm)

Standart	a	b	h
Standart	356	366	47

### Ağırlık

#### Weight (kg)

200W	0,86
------	------

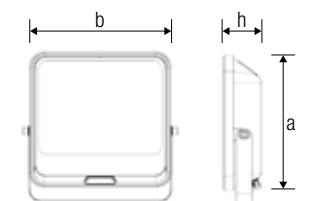



Alüminyum enjeksiyon gövde  
Elektrostatik toz boyalı  
Temperli cam

Aluminium injection body  
Electrostatic powder coated  
Tempered glass

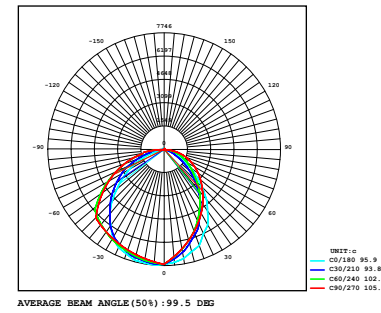

### Ürün Özellikleri

#### Product Features

IP Koruma Sınıfı / IP Protection Class	: IP 66
Kullanım Şekli / Usage	: Zemin Montaj / Floor Mount
Işık Kaynağı / Source of Light	: Mid Power LED

### Elektriksel Özellikleri

#### Electrical Properties

Giriş Gerilimi / Input Voltage	: 220-240 V
Giriş Frekans / Input Frequency	: 50-60 Hz
Max. Gerilim Dayanımı / Max. Voltage Strength	: 2 kV
Sürüş Akımı / Driving Current	: 700 mA
Güç Faktörü / Power Factor	: > 0.9
Renksel Geriverim İndeksi / Color Rendering Index	: > 80

### Diğer Özellikleri

#### Other Features

Çalışma Sıcaklık Aralığı / Operating Heat Range	: -20°C / +45°C
Darbe Dayanım (IK) / Impact Resistance	: IK10
Led Ömrü / Led Life	: 100.000 saat / hour

### Renk Sıcaklığı

Kelvin



### Opsiyonel Özellikler

#### Optional Features

Renk Sıcaklığı / Kelvin	: 3000K - 4000K - 6500K
DALI	: Var / Yes
Sensör / Sensor	: Var / Yes



Kod Code	Güç Power	Işık Akısı Lumen	Verimlilik Efficiency	Fiyat Price (\$)
VL519250	250W	32.875	131.5 lm/w	250.00
VL519300	300W	38.273	127.5 lm/w	260.00
VL519400	400W	47.992	119.9 lm/w	270.00
VL519500	500W	56.519	113.0 lm/w	350.00

### Ölçüler

#### Dimensions (mm)

Standart	a	b	h
Standart	451	476	135

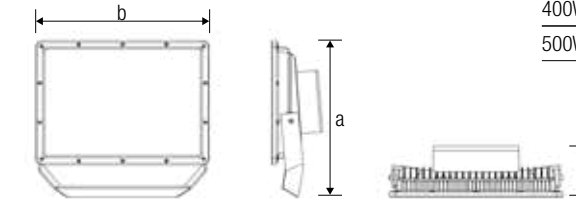

### Ağırlık

#### Weight (kg)

250W	8,20
300W	8,20
400W	8,80
500W	9,00

Kod Code	Güç Power	Işık Akısı Lumen	Verimlilik Efficiency	Fiyat Price (\$)
VL519600	600W	80.765	134.6 lm/w	600.00
VL519700	700W	91.574	130.8 lm/w	630.00
VL519800	800W	103.206	129.0 lm/w	650.00
VL519900	900W	113.337	125.9 lm/w	675.00
VL5191000	1000W	123.152	123.1 lm/w	700.00

### Ölçüler

#### Dimensions (mm)

Standart	a	b	h
Standart	468	773	94

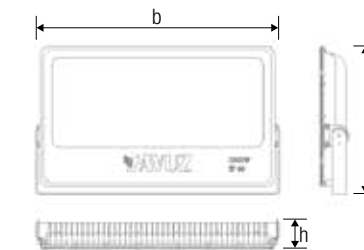

### Ağırlık

#### Weight (kg)

600W	14,90
700W	15,10
800W	15,30
900W	15,50
1000W	15,70



Alüminyum enjeksiyon gövde  
Elektrostatik toz boyalı  
Polikarbon modül lens

Aluminium injection body  
Electrostatic powder coated  
Polycarbonate modul lens



Kod Code	Güç Power	Işık Akısı Lumen	Verimlilik Efficiency	Fiyat Price (\$)
VL300300	300W	42.150	140.5 lm/w	1.400.00
VL300400	400W	56.120	140.3 lm/w	1.530.00
VL300500	500W	70.150	140.3 lm/w	1.670.00
VL300600	600W	84.120	140.2 lm/w	1.810.00

#### Ölçüler

Dimensions (mm)	a	b	h
Standart	451	476	91

#### Ağırlık

Weight (kg)	
300W	14,50
400W	15,50
500W	15,50
600W	16,50

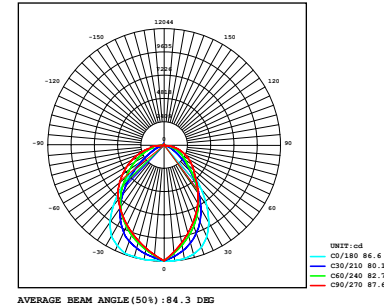

#### Ürün Özellikleri

##### Product Features

IP Koruma Sınıfı / IP Protection Class	: IP 67
Kullanım Şekli / Usage	: Direk Montaj / Pole Mount
Işık Kaynağı / Source of Light	: Mid Power LED

#### Elektriksel Özellikleri

##### Electrical Properties

Giriş Gerilimi / Input Voltage	: 220-240 V
Giriş Frekans / Input Frequency	: 50-60 Hz
Max. Gerilim Dayanımı / Max. Voltage Strength	: 10 kV
Sürüş Akımı / Driving Current	: 700 mA
Güç Faktörü / Power Factor	: > 0.95
Renksel Geriverim İndeksi / Color Rendering Index	: > 80

#### Renk Sıcaklığı

Kelvin



#### Diğer Özellikleri

##### Other Features

Çalışma Sıcaklık Aralığı / Operating Heat Range	: -20°C / +45°C
Darbe Dayanım (IK) / Impact Resistance	: IK10
Led Ömrü / Led Life	: 100.000 saat / hour

#### Opsiyonel Özellikler

##### Optional Features

Renk Sıcaklığı / Kelvin	: 3000K - 4000K - 6500K
DALI	: Var / Yes
Sensör / Sensor	: Var / Yes







Alüminyum enjeksiyon gövde  
Elektrostatik toz boyalı  
Temperli cam

Aluminium injection body  
Electrostatic powder coated  
Tempered glass

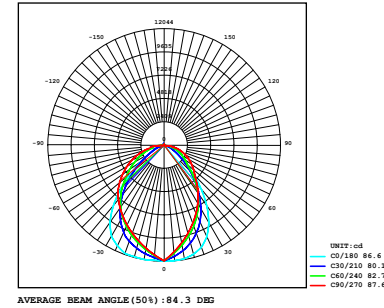

Kod Code	Güç Power	Işık Akısı Lumen	Verimlilik Efficiency	Fiyat Price (\$)
VL301500	500W	59.145	118.2 lm/w	950.00
VL301600	600W	70.809	118.0 lm/w	1.080.00
VL301700	700W	82.614	118.0 lm/w	1.240.00
VL301800	800W	94.403	118.0 lm/w	1.250.00
VL301900	900W	100.087	111.2 lm/w	1.260.00
VL3011000	1000W	118.132	118.1 lm/w	1.270.00

Ölçüler Dimensions (mm)	a	b	h
Standart	451	476	91

Ağırlık Weight (kg)	
500W	15,50
600W	16,50
700W	16,50
800W	17,50
900W	18,00
1000W	18,00

### Ürün Özellikleri

#### Product Features

IP Koruma Sınıfı / IP Protection Class	: IP 65
Kullanım Şekli / Usage	: Zemin Montaj / Floor Mount
Işık Kaynağı / Source of Light	: Mid Power LED

### Elektriksel Özellikleri

#### Electrical Properties

Giriş Gerilimi / Input Voltage	: 220-240 V
Giriş Frekans / Input Frequency	: 50-60 Hz
Max. Gerilim Dayanımı / Max. Voltage Strength	: 10 kV
Sürüş Akımı / Driving Current	: 700 mA
Güç Faktörü / Power Factor	: > 0.95
Renksel Geriverim İndeksi / Color Rendering Index	: > 80

### Diğer Özellikleri

#### Other Features

Çalışma Sıcaklık Aralığı / Operating Heat Range	: -20°C / +45°C
Darbe Dayanım (IK) / Impact Resistance	: IK10
Led Ömrü / Led Life	: 100.000 saat / hour

### Renk Sıcaklığı Kelvin



### Opsiyonel Özellikler

#### Optional Features

Renk Sıcaklığı / Kelvin	: 3000K - 4000K - 6500K
DALI	: Var / Yes
Sensör / Sensor	: Var / Yes



Alüminyum enjeksiyon gövde  
Elektrostatik toz boyalı  
Temperli cam / Polikarbon lens

Aluminium injection body  
Electrostatic powder coated  
Tempered glass / Polycarbonate lens

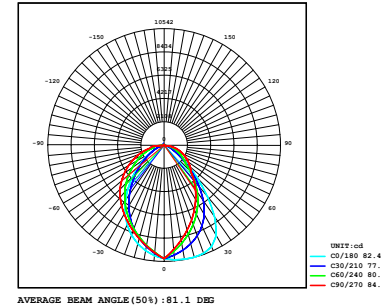

### Ürün Özellikleri

#### Product Features

IP Koruma Sınıfı / IP Protection Class	: IP 66
Kullanım Şekli / Usage	: Sıva Üstü / Surface Mounted
Işık Kaynağı / Source of Light	: Mid Power LED

### Elektriksel Özellikleri

#### Electrical Properties

Giriş Gerilimi / Input Voltage	: 220-240 V
Giriş Frekans / Input Frequency	: 50-60 Hz
Max. Gerilim Dayanımı / Max. Voltage Strength	: 6-10 kV
Sürüş Akımı / Driving Current	: 700 mA
Güç Faktörü / Power Factor	: > 0.95
Renk Geriverim İndeksi / Color Rendering Index	: > 80

### Diğer Özellikleri

#### Other Features

Çalışma Sıcaklık Aralığı / Operating Heat Range	: -20°C / +45°C
Darbe Dayanım (IK) / Impact Resistance	: IK10
Led Ömrü / Led Life	: 100.000 saat / hour

### Renk Sıcaklığı

Kelvin



### Opsiyonel Özellikler

#### Optional Features

Renk Sıcaklığı / Kelvin	: 3000K - 4000K - 6500K
DALI	: Var / Yes
Sensör / Sensor	: Var / Yes



Kod Code	Güç Power	Işık Akısı Lumen	Verimlilik Efficiency	Fiyat Price (\$)
VL509090	100W	11.436	114.3 lm/w	135.00

### Ölçüler

#### Dimensions (mm)

Standart	a	b	h
	280	280	134

### Ağırlık

#### Weight (kg)

100W	2,20
------	------

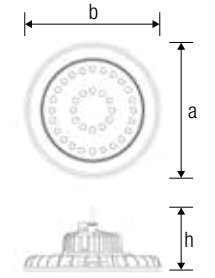

Kod Code	Güç Power	Işık Akısı Lumen	Verimlilik Efficiency	Fiyat Price (\$)
VL509120	120W	14.250	118.7 lm/w	170.00
VL509150	150W	17.316	115.4 lm/w	172.00
VL509200	200W	23.864	119.3 lm/w	180.00

### Ölçüler

#### Dimensions (mm)

Standart	a	b	h
	400	400	130

### Ağırlık

#### Weight (kg)

120W	3,81
150W	3,81
200W	3,81

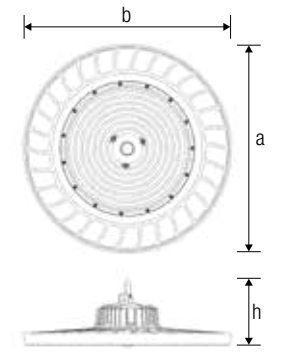

Kod Code : VL509EK1

Fiyat Price (\$) 13.00

\*Projektör kulp fiyatı / Metal Holder



Kod Code : VL509EK2

Fiyat Price (\$) 3.50

\*1 Metre sarkıt teli fiyatı / Hanging Kit





Alüminyum enjeksiyon gövde  
Elektrostatik toz boyalı  
Polikarbon lens

Aluminium injection body  
Electrostatic powder coated  
Polycarbonate lens

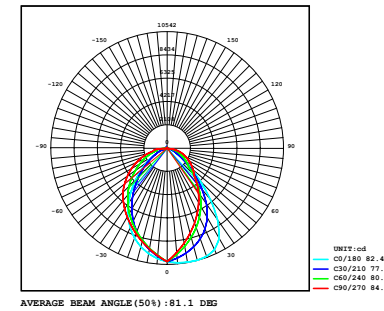

YENİ Yüksek Tavan Armatürü

**Ürün Özellikleri**

Product Features

IP Koruma Sınıfı / IP Protection Class	: IP 66
Kullanım Şekli / Usage	: Sıva Üstü / Surface Mounted
Işık Kaynağı / Source of Light	: Mid Power LED

**Elektriksel Özellikleri**

Electrical Properties

Giriş Gerilimi / Input Voltage	: 220-240 V
Giriş Frekans / Input Frequency	: 50-60 Hz
Max. Gerilim Dayanımı / Max. Voltage Strength	: 2 kV
Sürüş Akımı / Driving Current	: 700 mA
Güç Faktörü / Power Factor	: > 0.9
Renksel Geriverim İndeksi / Color Rendering Index	: > 80

**Diğer Özellikleri**

Other Features

Çalışma Sıcaklık Aralığı / Operating Heat Range	: -20°C / +45°C
Darbe Dayanım (IK) / Impact Resistance	: IK10
Led Ömrü / Led Life	: 100.000 saat / hour

**Renk Sıcaklığı**  
Kelvin



**Opsiyonel Özellikler**

Optional Features

Renk Sıcaklığı / Kelvin	: 3000K - 4000K - 6500K
DALI	: Var / Yes
Sensör / Sensor	: Var / Yes



Kod Code	Güç Power	Işık Akısı Lumen	Verimlilik Efficiency	Fiyat Price (\$)
VL509100-M	100W	11.436	114.3 lm/w	78.00
VL509120-M	120W	14.256	118.8 lm/w	95.00

**Ölçüler**

Dimensions (mm)

Standart	a	b	h
Standart	249	249	149

**Ağırlık**

Weight (kg)

100W	1,70
120W	1,70

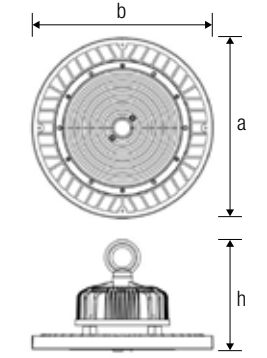

Kod Code	Güç Power	Işık Akısı Lumen	Verimlilik Efficiency	Fiyat Price (\$)
VL509150-M	150W	17.316	115.4 lm/w	97.00

**Ölçüler**

Dimensions (mm)

Standart	a	b	h
Standart	300	300	149

**Ağırlık**

Weight (kg)

150W	1,90
------	------

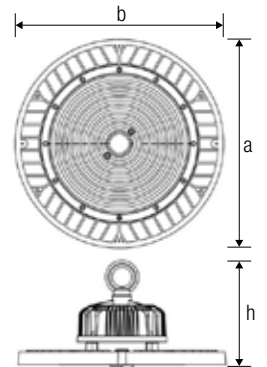

Kod Code	Güç Power	Işık Akısı Lumen	Verimlilik Efficiency	Fiyat Price (\$)
VL509200-M	200W	23.864	119.3 lm/w	120.00

**Ölçüler**

Dimensions (mm)

Standart	a	b	h
Standart	345	345	149

**Ağırlık**

Weight (kg)

200W	2,10
------	------

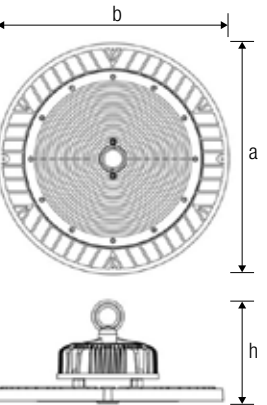

Sarkıt Askı Teli Pendant Wire	Metre (mm)	Fiyat Price (\$)
VL509EK2	1000	3.50



YENİ Akaryakıt İstasyon Armatürü

Alüminyum enjeksiyon gövde  
Elektrostatik toz boyalı  
Temperli cam

Aluminium injection body  
Electrostatic powder coated  
Tempered glass

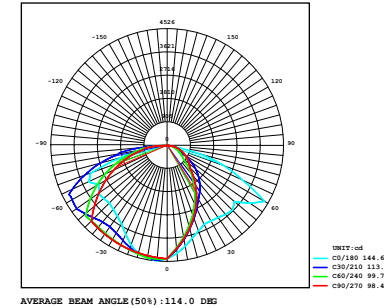

### Ürün Özellikleri

#### Product Features

IP Koruma Sınıfı / IP Protection Class	: IP 66
Kullanım Şekli / Usage	: Sıva Üstü-Altı / Surface-Recessed
Işık Kaynağı / Source of Light	: High / Mid Power LED
Optik / Optical	: Lens

### Elektriksel Özellikleri

#### Electrical Properties

Giriş Gerilimi / Input Voltage	: 220-240 V
Giriş Frekans / Input Frequency	: 50-60 Hz
Max. Gerilim Dayanımı / Max. Voltage Strength	: 2-10 kV
Sürüş Akımı / Driving Current	: 700 mA
Güç Faktörü / Power Factor	: > 0.95
Renk Geriverim İndeksi / Color Rendering Index	: > 80

### Diğer Özellikleri

#### Other Features

Çalışma Sıcaklık Aralığı / Operating Heat Range	: -20°C / +45°C
Darbe Dayanım (IK) / Impact Resistance	: IK10
Led Ömrü / Led Life	: 100.000 saat / hour

### Renk Sıcaklığı

Kelvin



### Opsiyonel Özellikler

#### Optional Features

Renk Sıcaklığı / Kelvin	: 3000K - 4000K - 6500K
DALI	: Var / Yes
Sensör / Sensor	: Var / Yes



VESTA - Kanopi



\*Çerçeve görünümü ve teknik çizimi



VESTA - Projektör



VESTA - Yüksek Tavan

Kod Code	Güç Power	Işık Akısı Lumen	Verimlilik Efficiency	Fiyat Price (\$)
VL600060	60W	9.580	159.6 lm/w	195.00
VL600075	75W	11.567	154.2 lm/w	200.00
VL600090	90W	13.365	148.5 lm/w	205.00

### Ölçüler

Dimensions (mm)	a	b	h	d
Standart	409	409	91	124

### Ağırlık

Weight (kg)	
60W	6,30
75W	6,30
90W	6,40

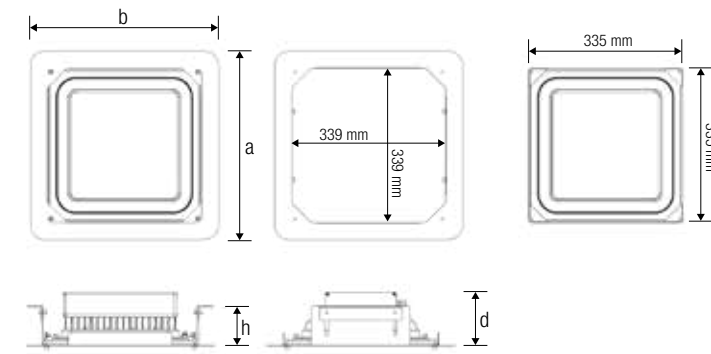

Kod Code	Güç Power	Işık Akısı Lumen	Verimlilik Efficiency	Fiyat Price (\$)
VL511100	100W	14.850	148.5 lm/w	275.00
VL511150	150W	20.661	137.7 lm/w	300.00
VL511200	200W	25.860	129.3 lm/w	315.00
VL511250	250W	30.547	122.1 lm/w	340.00

### Ölçüler

Dimensions (mm)	a	b	h
Standart	354	380	120

### Ağırlık

Weight (kg)	
100W-150W	4,00
200W-250W	4,10

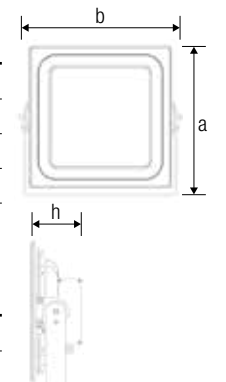

Kod Code	Güç Power	Işık Akısı Lumen	Verimlilik Efficiency	Fiyat Price (\$)
VL511100-YT	100W	14.850	148.5 lm/w	275.00
VL511150-YT	150W	20.661	137.7 lm/w	300.00
VL511200-YT	200W	25.860	129.3 lm/w	315.00
VL511250-YT	250W	30.547	122.1 lm/w	340.00

### Ölçüler

Dimensions (mm)	a	b	h
Standart	335	350	173

### Ağırlık

Weight (kg)	
100W-150W	4,00
200W-250W	4,10

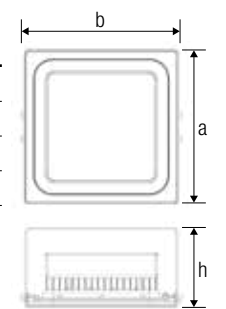



Alüminyum eloksal gövde  
Temperli cam

Aluminium anodized body  
Tempered glass

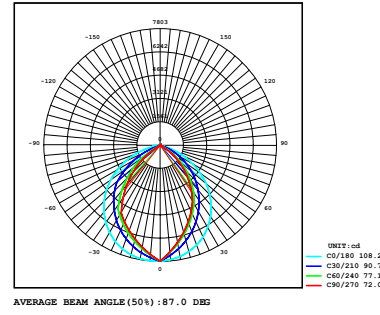

#### Ürün Özellikleri

##### Product Features

IP Koruma Sınıfı / IP Protection Class	: IP 66
Kullanım Şekli / Usage	: Tavan Montaj / Ceiling Mount
Işık Kaynağı / Source of Light	: Mid Power LED

#### Elektriksel Özellikleri

##### Electrical Properties

Giriş Gerilimi / Input Voltage	: 220-240 V
Giriş Frekans / Input Frequency	: 50-60 Hz
Max. Gerilim Dayanımı / Max. Voltage Strength	: 2 kV
Sürüş Akımı / Driving Current	: 700 mA
Güç Faktörü / Power Factor	: > 0.95
Renk Geriverim İndeksi / Color Rendering Index	: > 80

#### Diğer Özellikleri

##### Other Features

Çalışma Sıcaklık Aralığı / Operating Heat Range	: -20°C / +45°C
Darbe Dayanım (IK) / Impact Resistance	: IK10
Led Ömrü / Led Life	: 100.000 saat / hour

#### Renk Sıcaklığı

Kelvin



#### Opsiyonel Özellikler

##### Optional Features

Renk Sıcaklığı / Kelvin	: 3000K - 4000K - 6500K
DALI	: Var / Yes
Sensör / Sensor	: Var / Yes



Kod Code	Güç Power	Işık Akısı Lumen	Verimlilik Efficiency	Fiyat Price (\$)
VL528040	40W	5.271	131.7 lm/w	125.00
VL528070	70W	8.123	116.0 lm/w	140.00

#### Ölçüler

Dimensions (mm)	a	b	h
Standart	398	202	70

#### Ağırlık

Weight (kg)	
40W	3,45
70W	3,56

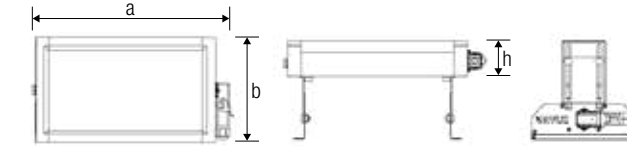

Kod Code	Güç Power	Işık Akısı Lumen	Verimlilik Efficiency	Fiyat Price (\$)
VL528100	100W	12.649	126.4 lm/w	210.00
VL528130	130W	15.378	118.2 lm/w	215.00

#### Ölçüler

Dimensions (mm)	a	b	h
Standart	685	202	70

#### Ağırlık

Weight (kg)	
100W	5,50
130W	5,61

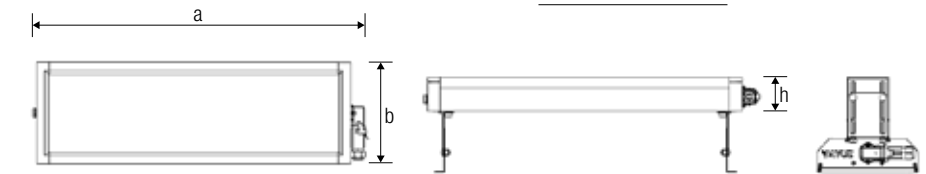

Kod Code	Güç Power	Işık Akısı Lumen	Verimlilik Efficiency	Fiyat Price (\$)
VL528155	150W	17.097	113.9 lm/w	345.00
VL528170	170W	22.080	129.8 lm/w	355.00
VL528220	220W	27.162	123.4 lm/w	370.00

#### Ölçüler

Dimensions (mm)	a	b	h
Standart	1258	202	70

#### Ağırlık

Weight (kg)	
150W	9,17
170W	9,17
220W	9,28

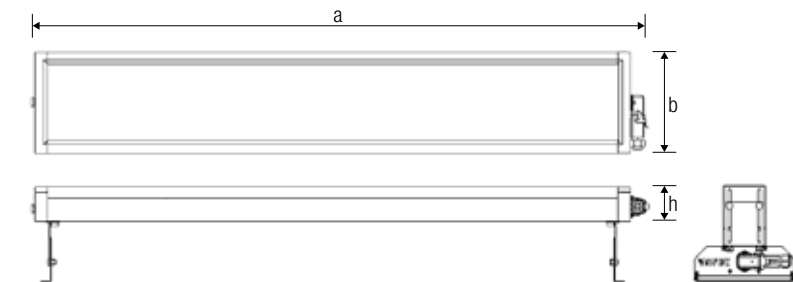



Alüminyum eloksal gövde  
Polikarbon lens  
Temperli cam

Aluminium anodized body  
Polycarbonate lens  
Tempered glass

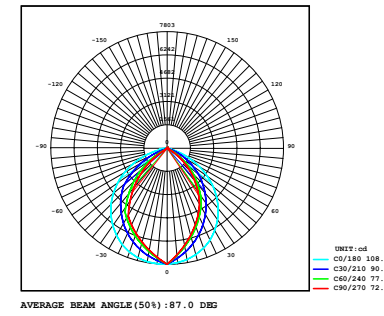

### Ürün Özellikleri

#### Product Features

IP Koruma Sınıfı / IP Protection Class	: IP 66
Kullanım Şekli / Usage	: Tavan Montaj / Ceiling Mount
Işık Kaynağı / Source of Light	: Mid Power LED

### Elektriksel Özellikleri

#### Electrical Properties

Giriş Gerilimi / Input Voltage	: 220-240 V
Giriş Frekans / Input Frequency	: 50-60 Hz
Max. Gerilim Dayanımı / Max. Voltage Strength	: 2 kV
Sürüş Akımı / Driving Current	: 700 mA
Güç Faktörü / Power Factor	: > 0.95
Renksel Geriverim İndeksi / Color Rendering Index	: > 80

### Diğer Özellikleri

#### Other Features

Çalışma Sıcaklık Aralığı / Operating Heat Range	: -20°C / +45°C
Darbe Dayanım (IK) / Impact Resistance	: IK10
Led Ömrü / Led Life	: 100.000 saat / hour

### Renk Sıcaklığı

Kelvin



### Opsiyonel Özellikler

#### Optional Features

Renk Sıcaklığı / Kelvin	: 3000K - 4000K - 6500K
DALI	: Var / Yes
Sensör / Sensor	: Var / Yes



Kod Code	Güç Power	Işık Akısı Lumen	Verimlilik Efficiency	Fiyat Price (\$)
VL528040-P	40W	6.137	153.4 lm/w	135.00
VL528070-P	70W	9.912	141.6 lm/w	150.00

### Ölçüler

Standart	a	b	h
Standart	398	202	70

### Ağırlık

Ağırlık (kg)	40W	70W
40W	3,50	
70W		3,61

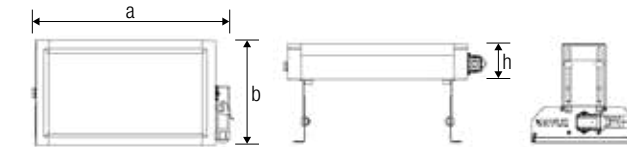

Kod Code	Güç Power	Işık Akısı Lumen	Verimlilik Efficiency	Fiyat Price (\$)
VL528100-P	100W	14.925	149.2 lm/w	235.00
VL528130-P	130W	18.626	143.2 lm/w	240.00

### Ölçüler

Standart	a	b	h
Standart	685	202	70

### Ağırlık

Ağırlık (kg)	100W	130W
100W	5,60	
130W		5,71

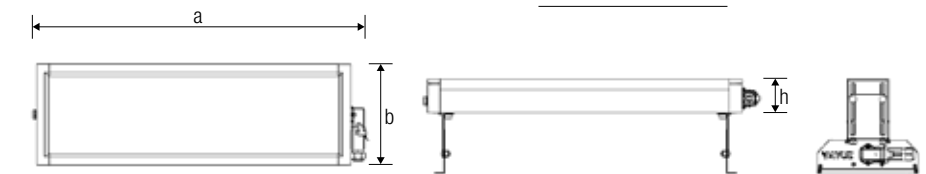

Kod Code	Güç Power	Işık Akısı Lumen	Verimlilik Efficiency	Fiyat Price (\$)
VL528155-P	150W	21.008	140.0 lm/w	390.00
VL528170-P	170W	36.439	214.3 lm/w	400.00
VL528220-P	220W	33.232	151.0 lm/w	420.00

### Ölçüler

Standart	a	b	h
Standart	1258	202	70

### Ağırlık

Ağırlık (kg)	150W	170W	220W
150W	9,42		
170W		9,42	
220W			9,53

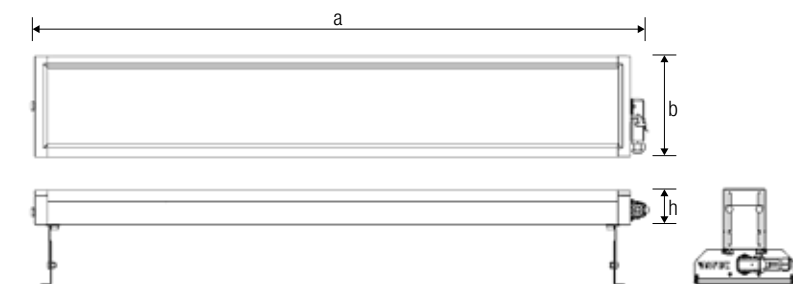



Alüminyum eloksal gövde  
Polikarbon cam

Aluminium anodized body  
Polycarbonate glass

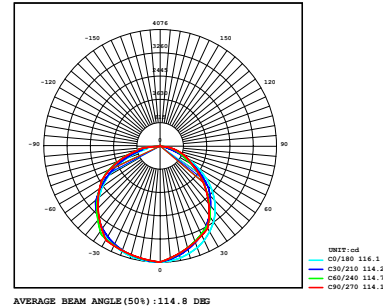

#### Ürün Özellikleri

##### Product Features

IP Koruma Sınıfı / IP Protection Class	: IP 54
Kullanım Şekli / Usage	: Tavan Montaj / Ceiling Mount
Işık Kaynağı / Source of Light	: Mid Power LED

#### Elektriksel Özellikleri

##### Electrical Properties

Giriş Gerilimi / Input Voltage	: 220-240 V
Giriş Frekans / Input Frequency	: 50-60 Hz
Max. Gerilim Dayanımı / Max. Voltage Strength	: 2 kV
Sürüş Akımı / Driving Current	: 700 mA
Güç Faktörü / Power Factor	: > 0.98
Renk Geriverim İndeksi / Color Rendering Index	: > 80

#### Diğer Özellikleri

##### Other Features

Çalışma Sıcaklık Aralığı / Operating Heat Range	: -20°C / +45°C
Darbe Dayanım (IK) / Impact Resistance	: IK09
Led Ömrü / Led Life	: 100.000 saat / hour

#### Renk Sıcaklığı

Kelvin



#### Opsiyonel Özellikler

##### Optional Features

Renk Sıcaklığı / Kelvin	: 3000K - 4000K - 6500K
DALI	: Var / Yes
Sensör / Sensor	: Var / Yes



Kod Code	Güç Power	Işık Akısı Lumen	Verimlilik Efficiency	Fiyat Price (\$)
VL528065-S	65W	7.196	110.0 lm/w	56.00
VL528080-S	80W	8.281	103.5 lm/w	58.00

#### Ölçüler

Standart	a	b	h
Standart	626	139	61

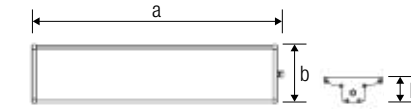

#### Ağırlık

Ağırlık Weight (kg)	Fiyat Price (\$)
65W	1,30
80W	1,30



Kod Code	Güç Power	Işık Akısı Lumen	Verimlilik Efficiency	Fiyat Price (\$)
VL528095-S	95W	10.280	108.2 lm/w	80.00

#### Ölçüler

Standart	a	b	h
Standart	926	139	61

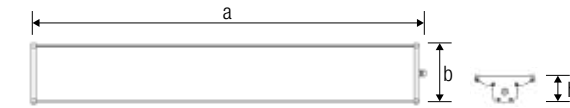

#### Ağırlık

Ağırlık Weight (kg)	Fiyat Price (\$)
95W	1,86



Kod Code	Güç Power	Işık Akısı Lumen	Verimlilik Efficiency	Fiyat Price (\$)
VL528095-S-120	95W	11.127	117.1 lm/w	90.00
VL528125-S	125W	13.502	108.0 lm/w	100.00
VL528150-S	150W	17.286	115.2 lm/w	120.00

#### Ölçüler

Standart	a	b	h
Standart	1226	139	61

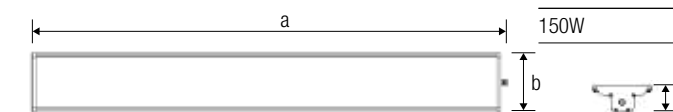

#### Ağırlık

Ağırlık Weight (kg)	Fiyat Price (\$)
95W	2,32
125W	2,40
150W	2,50



Kod Code	Güç Power	Işık Akısı Lumen	Verimlilik Efficiency	Fiyat Price (\$)
VL528175-S	175W	20.675	118.1 lm/w	160.00
VL528195-S	195W	22.706	116.4 lm/w	174.00

#### Ölçüler

Standart	a	b	h
Standart	1508	139	61

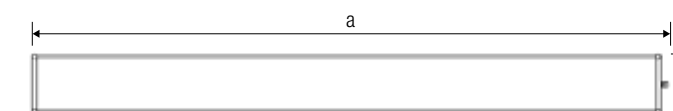

#### Ağırlık

Ağırlık Weight (kg)	Fiyat Price (\$)
175W	2,75
195W	3,12





Polikarbon gövde ve cam  
Polikarbon yekpare gövde

Polycarbonate body and glass  
Polycarbonate monolithic body

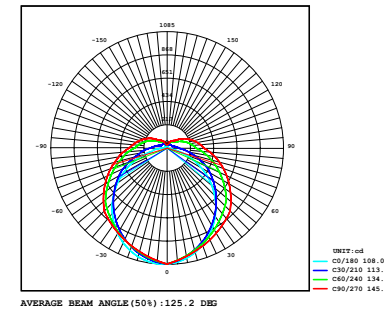

#### Ürün Özellikleri

##### Product Features

IP Koruma Sınıfı / IP Protection Class	: IP 65
Kullanım Şekli / Usage	: Sıva Üstü / Surface Mounted
Işık Kaynağı / Source of Light	: Mid Power LED

#### Elektriksel Özellikleri

##### Electrical Properties

Giriş Gerilimi / Input Voltage	: 220-240 V
Giriş Frekans / Input Frequency	: 50-60 Hz
Max. Gerilim Dayanımı / Max. Voltage Strength	: 2 kV
Sürüş Akımı / Driving Current	: 700 mA
Güç Faktörü / Power Factor	: > 0.95
Renksel Geriverim İndeksi / Color Rendering Index	: > 80

#### Diğer Özellikleri

##### Other Features

Çalışma Sıcaklık Aralığı / Operating Heat Range	: -20°C / +45°C
Darbe Dayanım (IK) / Impact Resistance	: IK10
Led Ömrü / Led Life	: 100.000 saat / hour

#### Renk Sıcaklığı

Kelvin



#### Opsiyonel Özellikler

##### Optional Features

Renk Sıcaklığı / Kelvin	: 3000K - 4000K - 6500K
DALI	: Var / Yes
Koridor Fonksiyonlu / Corridor Function	: Var / Yes
Sensör / Sensor	: Var / Yes



Kod Code	Güç Power	Işık Akısı Lumen	Verimlilik Efficiency	Fiyat Price (\$)
VL569018	18W	1.810	100.5 lm/w	39.00

#### Ölçüler

Dimensions (mm)

Standart	a	b	h
Standart	611	82	82

#### Ağırlık

Weight (kg)

18W	0,62
-----	------

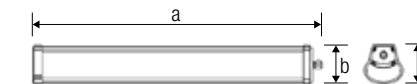

Kod Code	Güç Power	Işık Akısı Lumen	Verimlilik Efficiency	Fiyat Price (\$)
VL569030	30W	3.051	101.7 lm/w	54.00

#### Ölçüler

Dimensions (mm)

Standart	a	b	h
Standart	1032	82	82

#### Ağırlık

Weight (kg)

30W	0,89
-----	------

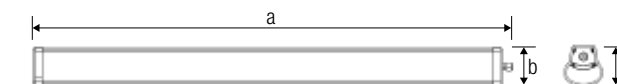

Kod Code	Güç Power	Işık Akısı Lumen	Verimlilik Efficiency	Fiyat Price (\$)
VL569036	36W	3.603	100.1 lm/w	57.00
VL569045	45W	4.518	100.4 lm/w	59.00

#### Ölçüler

Dimensions (mm)

Standart	a	b	h
Standart	1191	82	82

#### Ağırlık

Weight (kg)

36W	1,07
45W	1,07

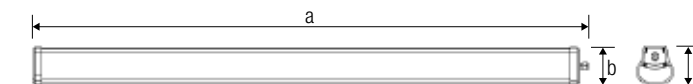

Kod Code	Güç Power	Işık Akısı Lumen	Verimlilik Efficiency	Fiyat Price (\$)
VL569055	55W	5.627	102.3 lm/w	111.00

#### Ölçüler

Dimensions (mm)

Standart	a	b	h
Standart	1511	82	82

#### Ağırlık

Weight (kg)

55W	1,40
-----	------

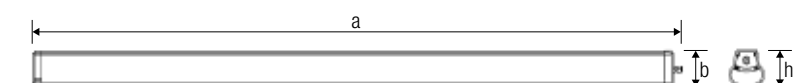





Alüminyum eloksal gövde  
Polikarbon cam

Aluminium anodized body  
Polycarbonate glass

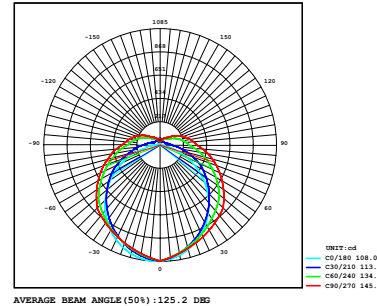

### Ürün Özellikleri

#### Product Features

IP Koruma Sınıfı / IP Protection Class	: IP 65
Kullanım Şekli / Usage	: Sıva Üstü / Surface Mounted
Işık Kaynağı / Source of Light	: Mid Power LED

### Elektriksel Özellikleri

#### Electrical Properties

Giriş Gerilimi / Input Voltage	: 220-240 V
Giriş Frekans / Input Frequency	: 50-60 Hz
Max. Gerilim Dayanımı / Max. Voltage Strength	: 2 kV
Sürüş Akımı / Driving Current	: 700 mA
Güç Faktörü / Power Factor	: > 0.95
Renk Geriverim İndeksi / Color Rendering Index	: > 80

### Diğer Özellikleri

#### Other Features

Çalışma Sıcaklık Aralığı / Operating Heat Range	: -20°C / +45°C
Darbe Dayanım (IK) / Impact Resistance	: IK10
Led Ömrü / Led Life	: 100.000 saat / hour

### Renk Sıcaklığı

Kelvin



### Opsiyonel Özellikler

#### Optional Features

Renk Sıcaklığı / Kelvin	: 3000K - 4000K - 6500K
DALI	: Var / Yes
Koridor Fonksiyonlu / Corridor Function	: Var / Yes
Sensör / Sensor	: Var / Yes



Kod Code	Güç Power	Işık Akısı Lumen	Verimlilik Efficiency	Fiyat Price (\$)
VL569018-LP	18W	1.850	102.7 lm/w	37.00

### Ölçüler

#### Dimensions (mm)

Standart	a	b	h
Standart	620	54	78

### Ağırlık

#### Weight (kg)

18W	0,72
-----	------



Kod Code	Güç Power	Işık Akısı Lumen	Verimlilik Efficiency	Fiyat Price (\$)
VL569030-LP	30W	3.051	101.7 lm/w	52.00

### Ölçüler

#### Dimensions (mm)

Standart	a	b	h
Standart	1023	54	78

### Ağırlık

#### Weight (kg)

30W	1,16
-----	------



Kod Code	Güç Power	Işık Akısı Lumen	Verimlilik Efficiency	Fiyat Price (\$)
VL569036-LP	36W	3.687	102.4 lm/w	56.00
VL569045-LP	45W	4.518	100.4 lm/w	58.00

### Ölçüler

#### Dimensions (mm)

Standart	a	b	h
Standart	1190	54	78

### Ağırlık

#### Weight (kg)

36W	1,32
45W	1,32

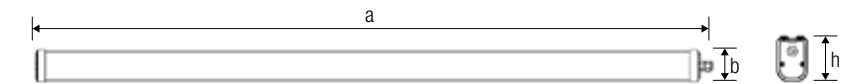

Kod Code	Güç Power	Işık Akısı Lumen	Verimlilik Efficiency	Fiyat Price (\$)
VL569055-LP	55W	5.627	102.3 lm/w	95.00

### Ölçüler

#### Dimensions (mm)

Standart	a	b	h
Standart	1500	54	78

### Ağırlık

#### Weight (kg)

55W	1,66
-----	------

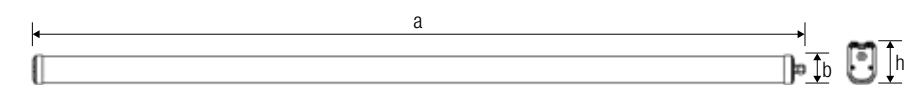



Alüminyum eloksal gövde  
Polikarbon cam

Aluminium anodized body  
Polycarbonate glass

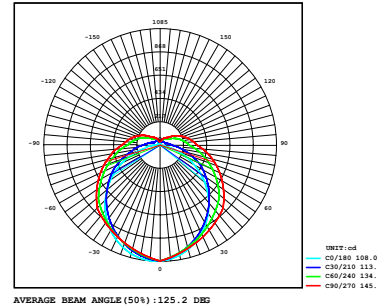

#### Ürün Özellikleri

##### Product Features

IP Koruma Sınıfı / IP Protection Class	: IP 54
Kullanım Şekli / Usage	: Sıva Üstü / Surface Mounted
Işık Kaynağı / Source of Light	: Mid Power LED

#### Elektriksel Özellikleri

##### Electrical Properties

Giriş Gerilimi / Input Voltage	: 220-240 V
Giriş Frekans / Input Frequency	: 50-60 Hz
Max. Gerilim Dayanımı / Max. Voltage Strength	: 2 kV
Sürüş Akımı / Driving Current	: 700 mA
Güç Faktörü / Power Factor	: > 0.95
Renk Geriverim İndeksi / Color Rendering Index	: > 80

#### Diğer Özellikleri

##### Other Features

Çalışma Sıcaklık Aralığı / Operating Heat Range	: -20°C / +45°C
Darbe Dayanım (IK) / Impact Resistance	: IK09
Led Ömrü / Led Life	: 100.000 saat / hour

#### Renk Sıcaklığı

Kelvin



#### Opsiyonel Özellikler

##### Optional Features

Renk Sıcaklığı / Kelvin	: 3000K - 4000K - 6500K
DALI	: Var / Yes
Koridor Fonksiyonlu / Corridor Function	: Var / Yes
Sensör / Sensor	: Var / Yes



Kod Code	Güç Power	Işık Akısı Lumen	Verimlilik Efficiency	Fiyat Price (\$)
VL569018-ALM	18W	1.850	102.7 lm/w	34.00

#### Ölçüler

##### Dimensions (mm)

Standart	a	b	h
Standart	620	54	59

#### Ağırlık

##### Weight (kg)

18W	0,64
-----	------

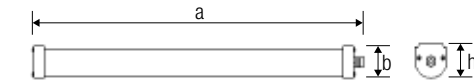

Kod Code	Güç Power	Işık Akısı Lumen	Verimlilik Efficiency	Fiyat Price (\$)
VL569030-ALM	30W	3.051	101.7 lm/w	47.00

#### Ölçüler

##### Dimensions (mm)

Standart	a	b	h
Standart	1023	54	59

#### Ağırlık

##### Weight (kg)

30W	0,87
-----	------



Kod Code	Güç Power	Işık Akısı Lumen	Verimlilik Efficiency	Fiyat Price (\$)
VL569036-ALM	36W	3.687	102.4 lm/w	50.00
VL569045-ALM	45W	4.518	100.4 lm/w	52.00

#### Ölçüler

##### Dimensions (mm)

Standart	a	b	h
Standart	1190	54	59

#### Ağırlık

##### Weight (kg)

36W	1,05
45W	1,05

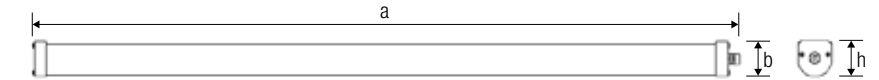

Kod Code	Güç Power	Işık Akısı Lumen	Verimlilik Efficiency	Fiyat Price (\$)
VL569055-ALM	55W	5.627	102.3 lm/w	87.00

#### Ölçüler

##### Dimensions (mm)

Standart	a	b	h
Standart	1500	54	59

#### Ağırlık

##### Weight (kg)

55W	1,37
-----	------

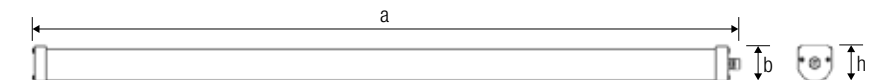



Polikarbon gövde ve cam  
Polikarbon yekpare gövde  
Polycarbonate body and glass  
Polycarbonate monolithic body

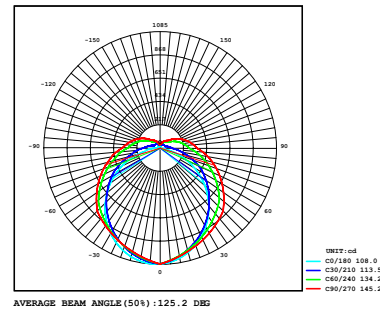

### Ürün Özellikleri

#### Product Features

IP Koruma Sınıfı / IP Protection Class	: IP 65
Kullanım Şekli / Usage	: Sıva Üstü / Surface Mounted
Işık Kaynağı / Source of Light	: Mid Power LED

### Elektriksel Özellikleri

#### Electrical Properties

Giriş Gerilimi / Input Voltage	: 220-240 V
Giriş Frekans / Input Frequency	: 50-60 Hz
Max. Gerilim Dayanımı / Max. Voltage Strength	: 2 kV
Sürüş Akımı / Driving Current	: 700 mA
Güç Faktörü / Power Factor	: > 0.9
Renk Geriverim İndeksi / Color Rendering Index	: > 80

### Diğer Özellikleri

#### Other Features

Çalışma Sıcaklık Aralığı / Operating Heat Range	: -20°C / +45°C
Darbe Dayanım (IK) / Impact Resistance	: IK09
Led Ömrü / Led Life	: 100.000 saat / hour

### Renk Sıcaklığı

Kelvin



### Opsiyonel Özellikler

#### Optional Features

Renk Sıcaklığı / Kelvin	: 3000K - 4000K - 6500K
DALI	: Var / Yes
Koridor Fonksiyonlu / Corridor Function	: Var / Yes
Sensör / Sensor	: Var / Yes



Kod Code	Güç Power	Işık Akısı Lumen	Verimlilik Efficiency	Fiyat Price (\$)
VL569018-PC	18W	1.850	102.7 lm/w	20.00

### Ölçüler

#### Dimensions (mm)

Standart	a	b	h
Standart	620	53	57

### Ağırlık

#### Weight (kg)

18W	0,33
-----	------

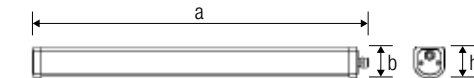

Kod Code	Güç Power	Işık Akısı Lumen	Verimlilik Efficiency	Fiyat Price (\$)
VL569030-PC	30W	3.051	101.7 lm/w	29.00

### Ölçüler

#### Dimensions (mm)

Standart	a	b	h
Standart	1023	53	57

### Ağırlık

#### Weight (kg)

30W	0,48
-----	------

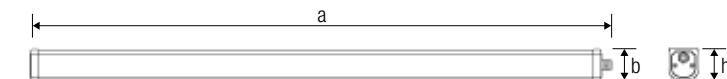

Kod Code	Güç Power	Işık Akısı Lumen	Verimlilik Efficiency	Fiyat Price (\$)
VL569036-PC	36W	3.687	102.4 lm/w	33.00

### Ölçüler

#### Dimensions (mm)

Standart	a	b	h
Standart	1190	53	57

### Ağırlık

#### Weight (kg)

36W	0,58
-----	------





Alüminyum eloksal gövde  
Temperli cam

Aluminium anodized body  
Tempered glass

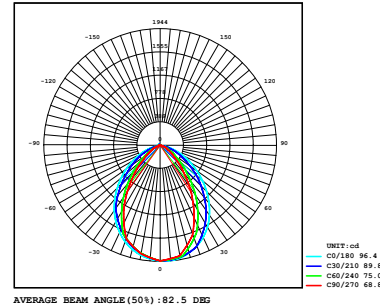

### Ürün Özellikleri

#### Product Features

IP Koruma Sınıfı / IP Protection Class	: IP 66
Kullanım Şekli / Usage	: Zemin Montaj / Floor Mounted
Işık Kaynağı / Source of Light	: Mid Power LED

### Elektriksel Özellikleri

#### Electrical Properties

Giriş Gerilimi / Input Voltage	: 220-240 V
Giriş Frekans / Input Frequency	: 50-60 Hz
Max. Gerilim Dayanımı / Max. Voltage Strength	: 2 kV
Sürüş Akımı / Driving Current	: 700 mA
Güç Faktörü / Power Factor	: > 0.95
Renksel Geriverim İndeksi / Color Rendering Index	: > 80

### Diğer Özellikleri

#### Other Features

Çalışma Sıcaklık Aralığı / Operating Heat Range	: -20°C / +45°C
Darbe Dayanım (IK) / Impact Resistance	: IK09
Led Ömrü / Led Life	: 100.000 saat / hour

### Renk Sıcaklığı

Kelvin

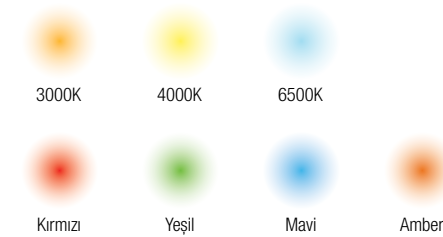

### Opsiyonel Özellikler

#### Optional Features

Renk Sıcaklığı / Kelvin	: 3000K - 4000K - 6500K
DALI	: Var / Yes
Sensör / Sensor	: Var / Yes



Kod Code	Güç Power	Işık Akısı Lumen	Verimlilik Efficiency	Fiyat Price (\$)
VL448009	9W	1.200	133.3 lm/w	41.00
VL458009	9W-RGB	1.200	133.3 lm/w	120.00

### Ölçüler

Dimensions (mm)	a	b	h	d
Standart	285	61	74	112

### Ağırlık

Weight (kg)	
9W	0,55

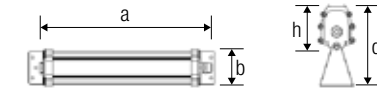

Kod Code	Güç Power	Işık Akısı Lumen	Verimlilik Efficiency	Fiyat Price (\$)
VL448018	18W	2.494	138.5 lm/w	59.00
VL458018	18W-RGB	2.494	138.5 lm/w	151.00

### Ölçüler

Dimensions (mm)	a	b	h	d
Standart	535	61	74	112

### Ağırlık

Weight (kg)	
18W	0,90

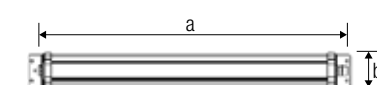

Kod Code	Güç Power	Işık Akısı Lumen	Verimlilik Efficiency	Fiyat Price (\$)
VL448036	36W	4.905	136.2 lm/w	88.00
VL458036	36W-RGB	4.905	136.2 lm/w	232.00

### Ölçüler

Dimensions (mm)	a	b	h	d
Standart	1005	61	74	112

### Ağırlık

Weight (kg)	
36W	1,63



Kod Code	Güç Power	Işık Akısı Lumen	Verimlilik Efficiency	Fiyat Price (\$)
VL448045	45W	6.163	136.9 lm/w	110.00

### Ölçüler

Dimensions (mm)	a	b	h	d
Standart	1285	61	74	112

### Ağırlık

Weight (kg)	
45W	1,90



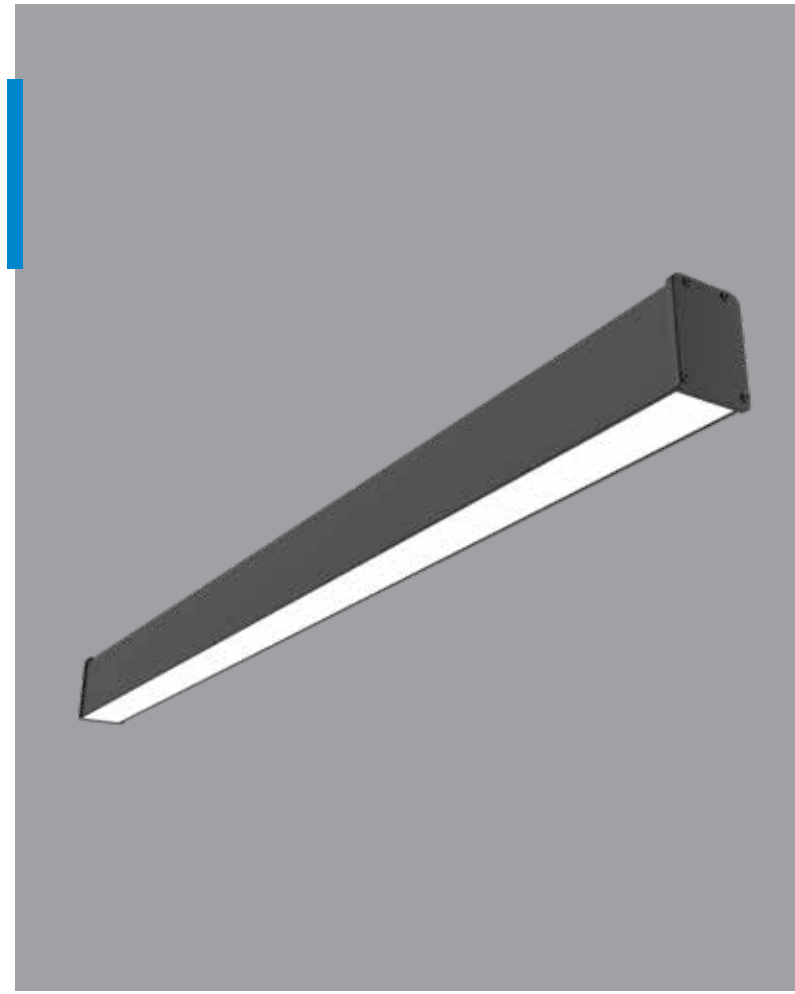

Alüminyum gövde  
Opal difüzör

Aluminium body  
Opaque diffuser

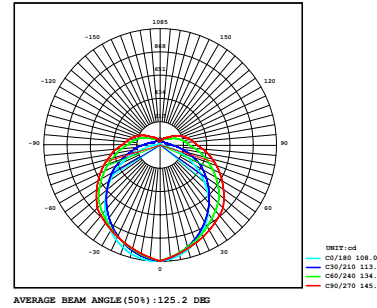

### Ürün Özellikleri

#### Product Features

IP Koruma Sınıfı / IP Protection Class	: IP 54
Kullanım Şekli / Usage	: Sıva Üstü / Surface Mounted
Işık Kaynağı / Source of Light	: Mid Power LED

### Elektriksel Özellikleri

#### Electrical Properties

Giriş Gerilimi / Input Voltage	: 220-240 V
Giriş Frekans / Input Frequency	: 50-60 Hz
Max. Gerilim Dayanımı / Max. Voltage Strength	: 2 kV
Sürüş Akımı / Driving Current	: 700 mA
Güç Faktörü / Power Factor	: > 0.98
Renk Geriverim İndeksi / Color Rendering Index	: > 80

### Diğer Özellikleri

#### Other Features

Çalışma Sıcaklık Aralığı / Operating Heat Range	: -20°C / +45°C
Darbe Dayanım (IK) / Impact Resistance	: IK09
Led Ömrü / Led Life	: 100.000 saat / hour

### Renk Sıcaklığı

Kelvin



### Opsiyonel Özellikler

#### Optional Features

Renk Sıcaklığı / Kelvin	: 3000K - 4000K - 6500K
DALI	: Var / Yes
Sensör / Sensor	: Var / Yes

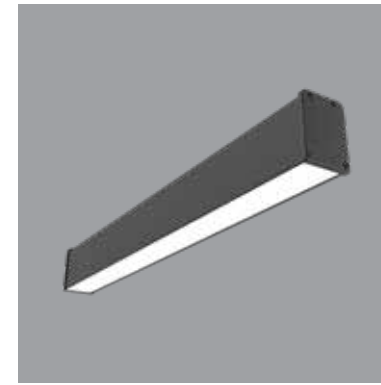

Kod Code	Güç Power	Işık Akısı Lumen	Verimlilik Efficiency	Fiyat Price (\$)
VL567015	15W	1.534	102.2 lm/w	34.00
VL567020	20W	2.025	101.2 lm/w	35.00

### Ölçüler

Standart	a	b	h
Standart	603	54	74

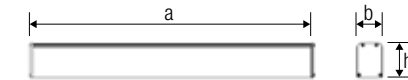

### Ağırlık

Ağırlık Weight (kg)	Fiyat Price (\$)
15W	1,13
20W	1,13

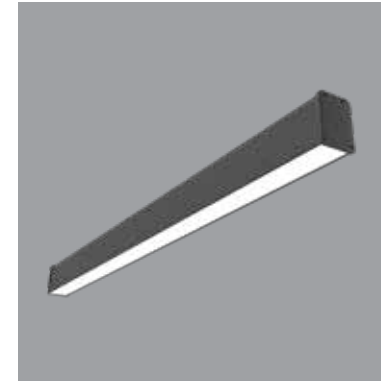

Kod Code	Güç Power	Işık Akısı Lumen	Verimlilik Efficiency	Fiyat Price (\$)
VL567030	30W	3.108	103.6 lm/w	47.00

### Ölçüler

Standart	a	b	h
Standart	1003	54	74

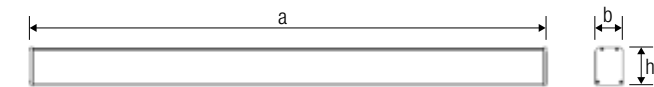

### Ağırlık

Ağırlık Weight (kg)	Fiyat Price (\$)
30W	1,20

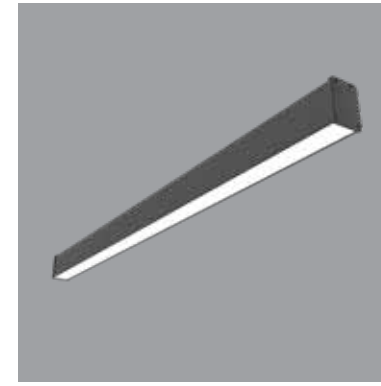

Kod Code	Güç Power	Işık Akısı Lumen	Verimlilik Efficiency	Fiyat Price (\$)
VL567036	36W	3.645	101.2 lm/w	53.00
VL567040	40W	4.130	103.2 lm/w	54.00

### Ölçüler

Standart	a	b	h
Standart	1203	54	74

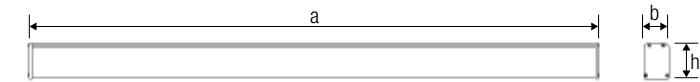

### Ağırlık

Ağırlık Weight (kg)	Fiyat Price (\$)
36W	1,30
40W	1,30

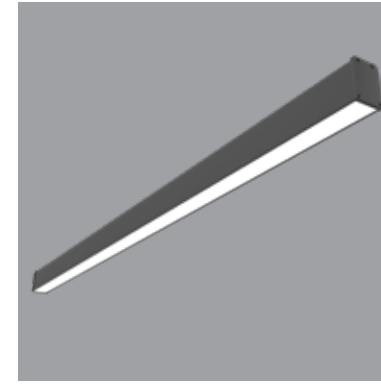

Kod Code	Güç Power	Işık Akısı Lumen	Verimlilik Efficiency	Fiyat Price (\$)
VL567050	50W	5.106	102.1 lm/w	61.00
VL567060	60W	6.033	100.5 lm/w	75.00

### Ölçüler

Standart	a	b	h
Standart	1443	54	74

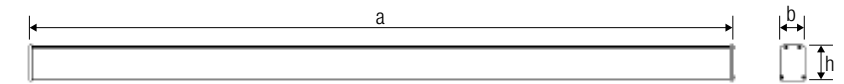

### Ağırlık

Ağırlık Weight (kg)	Fiyat Price (\$)
50W	1,63
60W	1,71

Sarkıt Askı Teli Pendant Wire	Metre (mm)	Fiyat Price (\$)
VL567EK1	2x1000	6.00





Alüminyum gövde  
Opal difüzör

Aluminium body  
Opaque diffuser

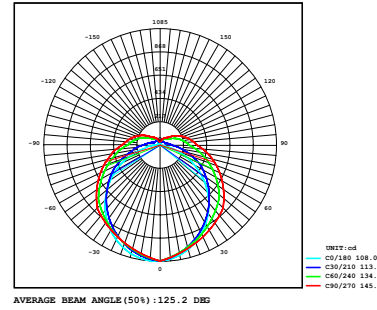

#### Ürün Özellikleri

##### Product Features

IP Koruma Sınıfı / IP Protection Class	: IP 54
Kullanım Şekli / Usage	: Sıva Altı / Recessed Mounted
Işık Kaynağı / Source of Light	: Mid Power LED

#### Elektriksel Özellikleri

##### Electrical Properties

Giriş Gerilimi / Input Voltage	: 220-240 V
Giriş Frekans / Input Frequency	: 50-60 Hz
Max. Gerilim Dayanımı / Max. Voltage Strength	: 2 kV
Sürüş Akımı / Driving Current	: 700 mA
Güç Faktörü / Power Factor	: > 0.98
Renk Geriverim İndeksi / Color Rendering Index	: > 80

#### Diğer Özellikleri

##### Other Features

Çalışma Sıcaklık Aralığı / Operating Heat Range	: -20°C / +45°C
Darbe Dayanım (IK) / Impact Resistance	: IK09
Led Ömrü / Led Life	: 100.000 saat / hour

#### Renk Sıcaklığı

Kelvin



#### Opsiyonel Özellikler

##### Optional Features

Renk Sıcaklığı / Kelvin	: 3000K - 4000K - 6500K
DALI	: Var / Yes
Sensör / Sensor	: Var / Yes



Kod Code	Güç Power	Işık Akısı Lumen	Verimlilik Efficiency	Fiyat Price (\$)
VL567015-SA	15W	1.534	102.2 lm/w	37.00
VL567020-SA	20W	2.025	101.2 lm/w	38.00

#### Ölçüler

Standart	a	b	h
Standart	603	50	70



#### Ağırlık

Ağırlık Weight (kg)	Fiyat Price (\$)
15W	0,80
20W	0,80



Kod Code	Güç Power	Işık Akısı Lumen	Verimlilik Efficiency	Fiyat Price (\$)
VL567030-SA	30W	3.108	103.6 lm/w	50.00

#### Ölçüler

Standart	a	b	h
Standart	1003	50	70

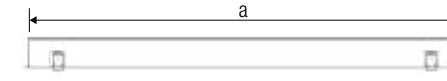

#### Ağırlık

Ağırlık Weight (kg)	Fiyat Price (\$)
30W	1,21

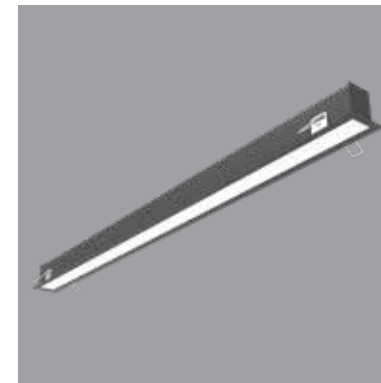

Kod Code	Güç Power	Işık Akısı Lumen	Verimlilik Efficiency	Fiyat Price (\$)
VL567036-SA	36W	3.645	101.2 lm/w	58.00
VL567040-SA	40W	4.130	103.2 lm/w	59.00

#### Ölçüler

Standart	a	b	h
Standart	1203	50	70

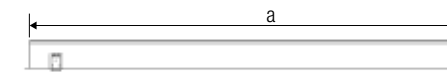

#### Ağırlık

Ağırlık Weight (kg)	Fiyat Price (\$)
36W	1,39
40W	1,39



Kod Code	Güç Power	Işık Akısı Lumen	Verimlilik Efficiency	Fiyat Price (\$)
VL567050-SA	50W	5.106	102.1 lm/w	68.00
VL567060-SA	60W	6.033	100.5 lm/w	80.00

#### Ölçüler

Standart	a	b	h
Standart	1443	50	70

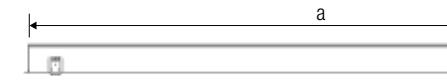

#### Ağırlık

Ağırlık Weight (kg)	Fiyat Price (\$)
50W	1,75
60W	1,83

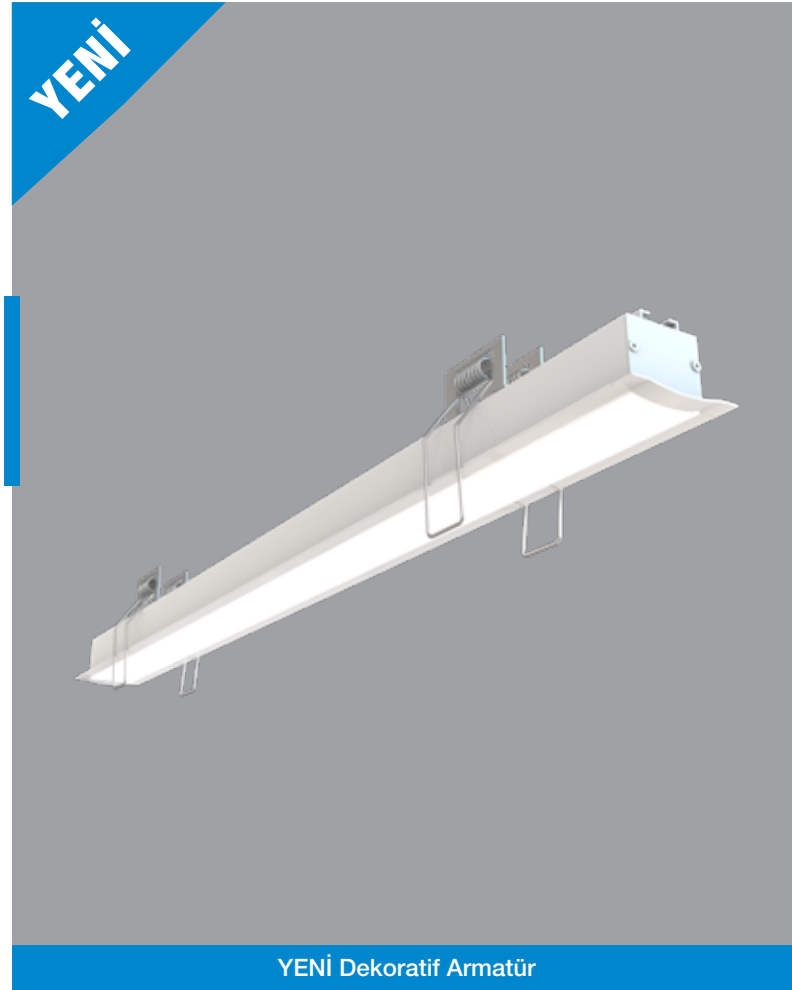

Alüminyum gövde  
Opal difüzör

Aluminium body  
Opaque diffuser

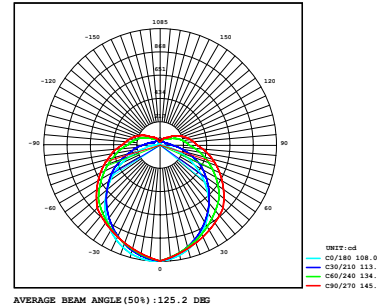

### Ürün Özellikleri

#### Product Features

IP Koruma Sınıfı / IP Protection Class	: IP 54
Kullanım Şekli / Usage	: Sıva Altı / Recessed Mounted
Işık Kaynağı / Source of Light	: Mid Power LED

### Elektriksel Özellikleri

#### Electrical Properties

Giriş Gerilimi / Input Voltage	: 220-240 V
Giriş Frekans / Input Frequency	: 50-60 Hz
Max. Gerilim Dayanımı / Max. Voltage Strength	: 2 kV
Sürüş Akımı / Driving Current	: 700 mA
Güç Faktörü / Power Factor	: > 0.98
Renk Geriverim İndeksi / Color Rendering Index	: > 80

### Diğer Özellikleri

#### Other Features

Çalışma Sıcaklık Aralığı / Operating Heat Range	: -20°C / +45°C
Darbe Dayanım (IK) / Impact Resistance	: IK09
Led Ömrü / Led Life	: 100.000 saat / hour

### Renk Sıcaklığı

Kelvin



### Opsiyonel Özellikler

#### Optional Features

Renk Sıcaklığı / Kelvin	: 3000K - 4000K - 6500K
DALI	: Var / Yes
Sensör / Sensor	: Var / Yes

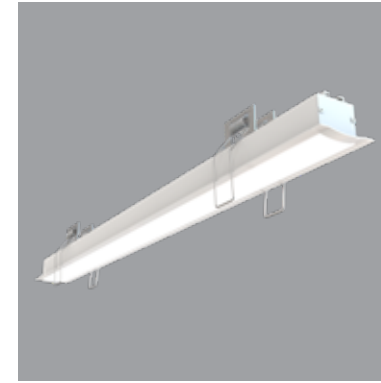

Kod Code	Güç Power	Işık Akısı Lumen	Verimlilik Efficiency	Fiyat Price (\$)
VL568015	15W	1.534	102.2 lm/w	30.00
VL568020	20W	2.025	101.2 lm/w	31.00

### Ölçüler

Standart	a	b	h
Standart	603	34	34

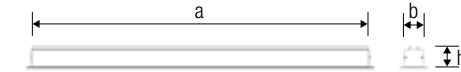

### Ağırlık

Ağırlık Weight (kg)	Fiyat Price (\$)
15W	0,47
20W	0,47



Kod Code	Güç Power	Işık Akısı Lumen	Verimlilik Efficiency	Fiyat Price (\$)
VL568030	30W	3.108	103.6 lm/w	38.00

### Ölçüler

Standart	a	b	h
Standart	1003	34	34

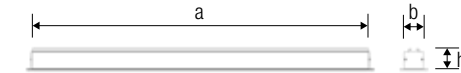

### Ağırlık

Ağırlık Weight (kg)	Fiyat Price (\$)
30W	0,70



Kod Code	Güç Power	Işık Akısı Lumen	Verimlilik Efficiency	Fiyat Price (\$)
VL568036	36W	3.645	101.2 lm/w	43.00
VL568040	40W	4.130	103.2 lm/w	44.00

### Ölçüler

Standart	a	b	h
Standart	1203	34	34

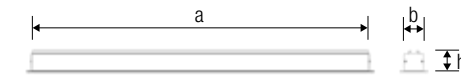

### Ağırlık

Ağırlık Weight (kg)	Fiyat Price (\$)
36W	0,81
40W	0,81



Kod Code	Güç Power	Işık Akısı Lumen	Verimlilik Efficiency	Fiyat Price (\$)
VL568050	50W	5.106	102.1 lm/w	49.00
VL568060	60W	6.033	100.5 lm/w	62.00

### Ölçüler

Standart	a	b	h
Standart	1443	34	34

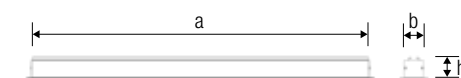

### Ağırlık

Ağırlık Weight (kg)	Fiyat Price (\$)
50W	1,10
60W	1,15



Alüminyum gövde  
Opal difüzör

Aluminium body  
Opaque diffuser

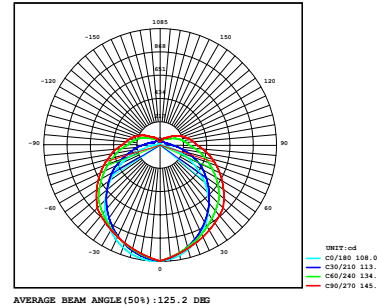

YENİ Dekoratif Armatür

#### Ürün Özellikleri

##### Product Features

IP Koruma Sınıfı / IP Protection Class	: IP 20
Kullanım Şekli / Usage	: Sıva Üstü / Sıva Altı
Işık Kaynağı / Source of Light	: Mid Power LED

#### Elektriksel Özellikleri

##### Electrical Properties

Giriş Gerilimi / Input Voltage	: 24 V DC
--------------------------------	-----------

#### Diğer Özellikleri

##### Other Features

Çalışma Sıcaklık Aralığı / Operating Heat Range	: -20°C / +45°C
Darbe Dayanım (IK) / Impact Resistance	: IK09
Led Ömrü / Led Life	: 100.000 saat / hour

#### Renk Sıcaklığı

Kelvin



#### Opsiyonel Özellikler

##### Optional Features

Renk Sıcaklığı / Kelvin	: 3000K - 4000K - 6500K
Sensör / Sensor	: Var / Yes



Gizli Aydınlatma Cove Lighting

Kod Code	Güç Power	Işık Akısı Lumen	Verimlilik Efficiency	Fiyat Price (\$)
VL570014	14W	1.442	103.0 lm/w	20.00

#### Ölçüler

Dimensions (mm)	a	b	h
Standart	1000	19	12

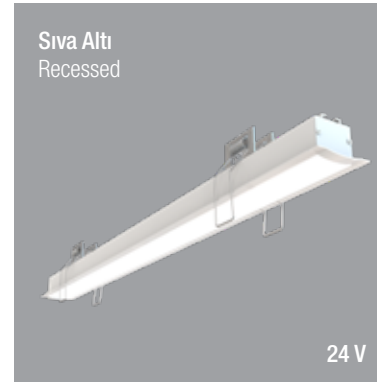
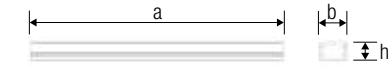

Kod Code	Güç Power	Işık Akısı Lumen	Verimlilik Efficiency	Fiyat Price (\$)
VL568024	14W	1.442	103.0 lm/w	26.00

#### Ölçüler

Dimensions (mm)	a	b	h
Standart	1003	34	34

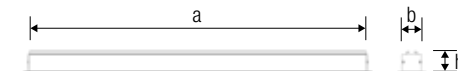

#### 2.2 Amper LED Trafosu

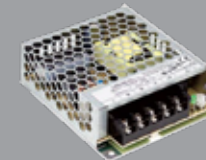

Ürün Kodu	: VL240050
Giriş Gerilimi	: 220 V
Çıkış Gerilimi	: 24 V
Güç	: 50W
Ölçü (mm)	: 82 x 99 x 30
	<b>29.00 \$</b>

#### 4.5 Amper LED Trafosu

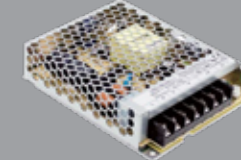

Ürün Kodu	: VL240100
Giriş Gerilimi	: 220 V
Çıkış Gerilimi	: 24 V
Güç	: 100W
Ölçü (mm)	: 97 x 129 x 30
	<b>40.00 \$</b>

#### 6.5 Amper LED Trafosu



Ürün Kodu	: VL240150
Giriş Gerilimi	: 220 V
Çıkış Gerilimi	: 24 V
Güç	: 150W
Ölçü (mm)	: 97 x 159 x 30
	<b>49.00 \$</b>

#### 8.8 Amper LED Trafosu



Ürün Kodu	: VL240200
Giriş Gerilimi	: 220 V
Çıkış Gerilimi	: 24 V
Güç	: 200W
Ölçü (mm)	: 115 x 215 x 30
	<b>68.00 \$</b>

#### 2.1 Amper LED Sürücü



Ürün Kodu	: VL241050
Giriş Gerilimi	: 220 V
Çıkış Gerilimi	: 24 V
Güç	: 50W
Ölçü (mm)	: 63 x 105 x 30
	<b>57.00 \$</b>

#### 4 Amper LED Sürücü



Ürün Kodu	: VL241100
Giriş Gerilimi	: 220 V
Çıkış Gerilimi	: 24 V
Güç	: 100W
Ölçü (mm)	: 63 x 140 x 32
	<b>75.00 \$</b>

#### 6.25 Amper LED Sürücü



Ürün Kodu	: VL241150
Giriş Gerilimi	: 220 V
Çıkış Gerilimi	: 24 V
Güç	: 150W
Ölçü (mm)	: 63 x 180 x 35,5
	<b>87.00 \$</b>

#### 8.3 Amper LED Sürücü



Ürün Kodu	: VL241200
Giriş Gerilimi	: 220 V
Çıkış Gerilimi	: 24 V
Güç	: 200W
Ölçü (mm)	: 63 x 199 x 35,5
	<b>97.00 \$</b>







Alüminyum gövde  
Opal difüzör

Aluminium body  
Opaque diffuser

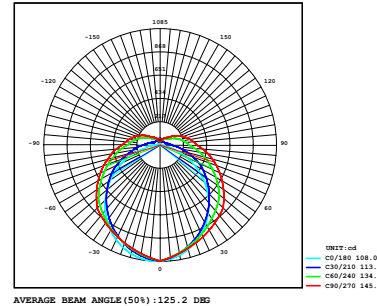

### Ürün Özellikleri

#### Product Features

IP Koruma Sınıfı / IP Protection Class	: IP 54
Kullanım Şekli / Usage	: Sarkıt / Suspended
Işık Kaynağı / Source of Light	: Mid Power LED

### Elektriksel Özellikleri

#### Electrical Properties

Giriş Gerilimi / Input Voltage	: 220-240 V
Giriş Frekans / Input Frequency	: 50-60 Hz
Max. Gerilim Dayanımı / Max. Voltage Strength	: 2 kV
Sürüş Akımı / Driving Current	: 700 mA
Güç Faktörü / Power Factor	: > 0.9
Renksel Geriverim İndeksi / Color Rendering Index	: > 80

### Diğer Özellikleri

#### Other Features

Çalışma Sıcaklık Aralığı / Operating Heat Range	: -20°C / +45°C
Darbe Dayanım (IK) / Impact Resistance	: IK09
Led Ömrü / Led Life	: 100.000 saat / hour

### Renk Sıcaklığı

Kelvin



### Opsiyonel Özellikler

#### Optional Features

Renk Sıcaklığı / Kelvin	: 3000K - 4000K - 6500K
DALI	: Var / Yes
Sensör / Sensor	: Var / Yes



Rozans	Adet	Fiyat
Rozans	Piece	Price (\$)
VL564EK1	1	3.00

Kod	Güç	Işık Akısı	Verimlilik	Fiyat
Code	Power	Lumen	Efficiency	Price (\$)
VL564040	40W	3.138	78.4 lm/w	125.00

### Ölçüler

#### Dimensions (mm)

Standart	a	b	h
Standart	370	370	94

### Ağırlık

#### Weight (kg)

40W	3,10
-----	------

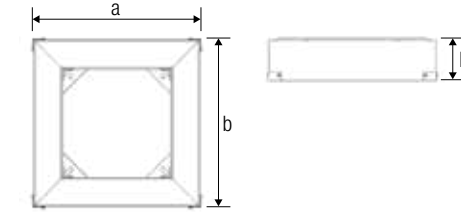

Kod	Güç	Işık Akısı	Verimlilik	Fiyat
Code	Power	Lumen	Efficiency	Price (\$)
VL564060	60W	4.512	75.2 lm/w	190.00

### Ölçüler

#### Dimensions (mm)

Standart	a	b	h
Standart	650	650	94

### Ağırlık

#### Weight (kg)

60W	5,45
-----	------

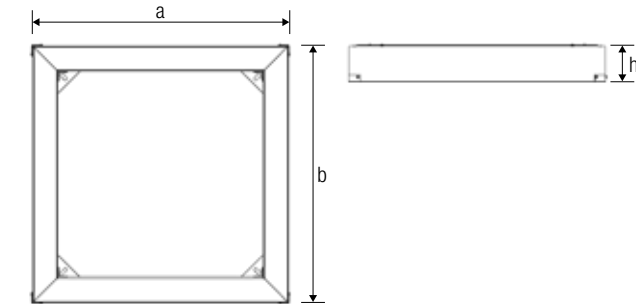

Kod	Güç	Işık Akısı	Verimlilik	Fiyat
Code	Power	Lumen	Efficiency	Price (\$)
VL564100	100W	7.471	74.7 lm/w	380.00

### Ölçüler

#### Dimensions (mm)

Standart	a	b	h
Standart	1200	1200	94

### Ağırlık

#### Weight (kg)

100W	9,97
------	------

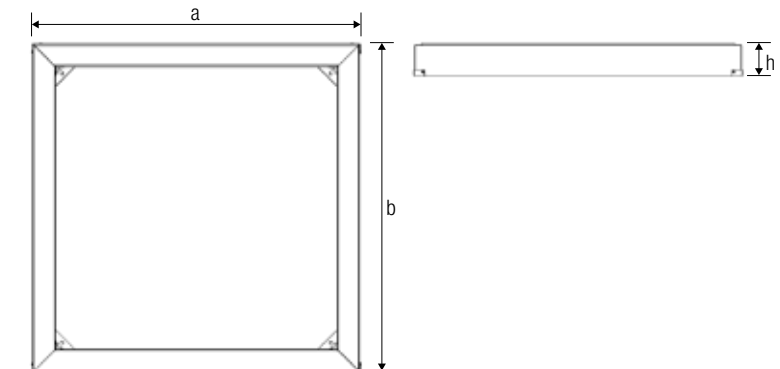



Alüminyum gövde  
Opal difüzör

Aluminium body  
Opaque diffuser

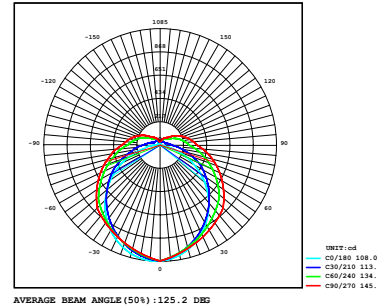

### Ürün Özellikleri

#### Product Features

IP Koruma Sınıfı / IP Protection Class	: IP 54
Kullanım Şekli / Usage	: Sarkıt / Suspended
Işık Kaynağı / Source of Light	: Mid Power LED

### Elektriksel Özellikleri

#### Electrical Properties

Giriş Gerilimi / Input Voltage	: 220-240 V
Giriş Frekans / Input Frequency	: 50-60 Hz
Max. Gerilim Dayanımı / Max. Voltage Strength	: 2 kV
Sürüş Akımı / Driving Current	: 700 mA
Güç Faktörü / Power Factor	: > 0.9
Renksel Geriverim İndeksi / Color Rendering Index	: > 80

### Diğer Özellikleri

#### Other Features

Çalışma Sıcaklık Aralığı / Operating Heat Range	: -20°C / +45°C
Darbe Dayanım (IK) / Impact Resistance	: IK09
Led Ömrü / Led Life	: 100.000 saat / hour

### Renk Sıcaklığı

Kelvin



### Opsiyonel Özellikler

#### Optional Features

Renk Sıcaklığı / Kelvin	: 3000K - 4000K - 6500K
DALI	: Var / Yes
Sensör / Sensor	: Var / Yes



Kod Code	Güç Power	Işık Akısı Lumen	Verimlilik Efficiency	Fiyat Price (\$)
VL565040	40W	3.138	78.4 lm/w	125.00

### Ölçüler

#### Dimensions (mm)

Standart	a	b	h
Standart	400	400	80

### Ağırlık

#### Weight (kg)

40W	2,50
-----	------

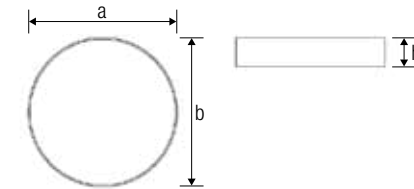

Kod Code	Güç Power	Işık Akısı Lumen	Verimlilik Efficiency	Fiyat Price (\$)
VL565060	60W	4.512	75.2 lm/w	220.00

### Ölçüler

#### Dimensions (mm)

Standart	a	b	h
Standart	600	600	80

### Ağırlık

#### Weight (kg)

60W	3,40
-----	------

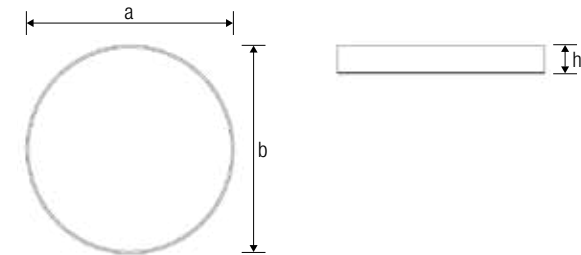

Kod Code	Güç Power	Işık Akısı Lumen	Verimlilik Efficiency	Fiyat Price (\$)
VL565100	100W	7.471	74.7 lm/w	490.00

### Ölçüler

#### Dimensions (mm)

Standart	a	b	h
Standart	900	900	80

### Ağırlık

#### Weight (kg)

100W	4,30
------	------

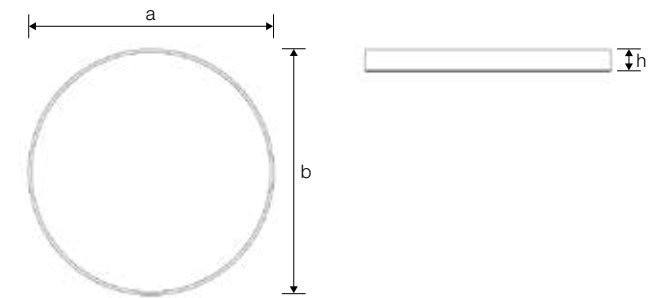

Rozans Rozans	Adet Piece	Fiyat Price (\$)
VL564EK1	1	3.00



Alüminyum gövde  
Opal difüzör

Aluminium body  
Opaque diffuser

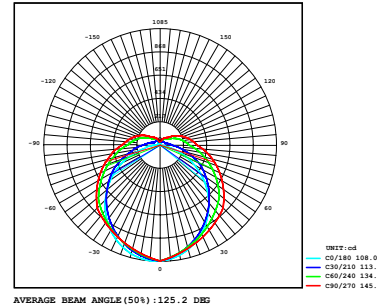

### Ürün Özellikleri

#### Product Features

IP Koruma Sınıfı / IP Protection Class	: IP 54
Kullanım Şekli / Usage	: Sarkıt / Suspended
Işık Kaynağı / Source of Light	: Mid Power LED

### Elektriksel Özellikleri

#### Electrical Properties

Giriş Gerilimi / Input Voltage	: 220-240 V
Giriş Frekans / Input Frequency	: 50-60 Hz
Max. Gerilim Dayanımı / Max. Voltage Strength	: 2 kV
Sürüş Akımı / Driving Current	: 700 mA
Güç Faktörü / Power Factor	: > 0.9
Renksel Geriverim İndeksi / Color Rendering Index	: > 80

### Diğer Özellikleri

#### Other Features

Çalışma Sıcaklık Aralığı / Operating Heat Range	: -20°C / +45°C
Darbe Dayanım (IK) / Impact Resistance	: IK09
Led Ömrü / Led Life	: 100.000 saat / hour

### Renk Sıcaklığı

Kelvin



### Opsiyonel Özellikler

#### Optional Features

Renk Sıcaklığı / Kelvin	: 3000K - 4000K - 6500K
DALI	: Var / Yes
Sensör / Sensor	: Var / Yes



Kod Code	Güç Power	Işık Akısı Lumen	Verimlilik Efficiency	Fiyat Price (\$)
VL566040	40W	3.138	78.4 lm/w	66.00

### Ölçüler

#### Dimensions (mm)

Standart	a	b	h
Standart	400	400	80

### Ağırlık

#### Weight (kg)

40W	2,50
-----	------

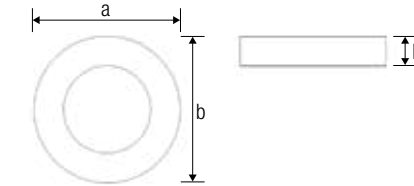

Kod Code	Güç Power	Işık Akısı Lumen	Verimlilik Efficiency	Fiyat Price (\$)
VL566060	60W	4.512	75.2 lm/w	108.00

### Ölçüler

#### Dimensions (mm)

Standart	a	b	h
Standart	600	600	80

### Ağırlık

#### Weight (kg)

60W	3,40
-----	------

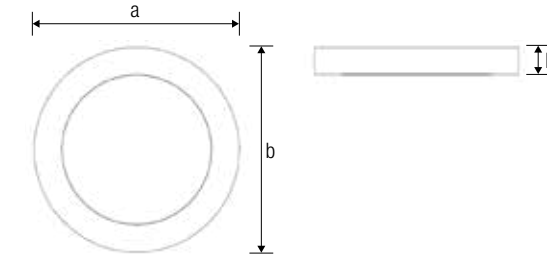

Kod Code	Güç Power	Işık Akısı Lumen	Verimlilik Efficiency	Fiyat Price (\$)
VL566100	100W	7.471	74.7 lm/w	165.00

### Ölçüler

#### Dimensions (mm)

Standart	a	b	h
Standart	900	900	80

### Ağırlık

#### Weight (kg)

100W	4,30
------	------

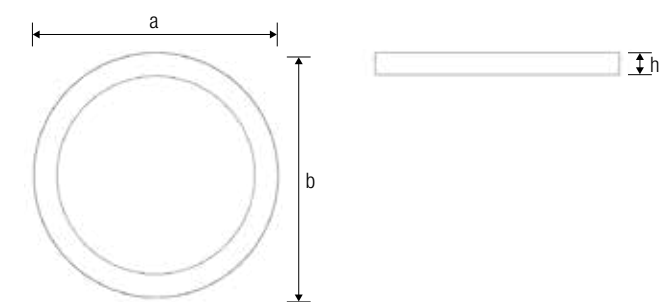

Rozans Rozans	Adet Piece	Fiyat Price (\$)
VL564EK1	1	3.00



Alüminyum gövde  
Elektrostatik toz boyalı  
Opal difüzör

Aluminium body  
Electrostatic powder coated  
Opaque diffuser

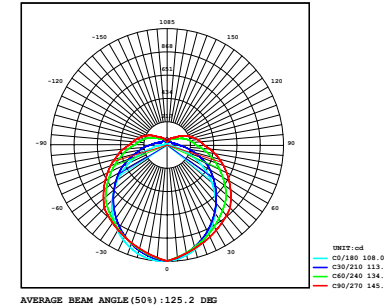

### Ürün Özellikleri

#### Product Features

IP Koruma Sınıfı / IP Protection Class	: IP 40
Kullanım Şekli / Usage	: Sıva Altı / Recessed Mounted
Işık Kaynağı / Source of Light	: Mid Power LED

### Elektriksel Özellikleri

#### Electrical Properties

Giriş Gerilimi / Input Voltage	: 220-240 V
Giriş Frekans / Input Frequency	: 50-60 Hz
Max. Gerilim Dayanımı / Max. Voltage Strength	: 2 kV
Sürüş Akımı / Driving Current	: 700 mA
Güç Faktörü / Power Factor	: > 0.95
Renksel Geriverim İndeksi / Color Rendering Index	: > 80

### Diğer Özellikleri

#### Other Features

Çalışma Sıcaklık Aralığı / Operating Heat Range	: -20°C / +45°C
Darbe Dayanım (IK) / Impact Resistance	: IK05
Led Ömrü / Led Life	: 100.000 saat / hour

### Renk Sıcaklığı

Kelvin



### Opsiyonel Özellikler

#### Optional Features

Renk Sıcaklığı / Kelvin	: 3000K - 4000K - 6500K
DALI	: Var / Yes
Sensör / Sensor	: Var / Yes



Kod Code	Güç Power	Işık Akısı Lumen	Verimlilik Efficiency	Fiyat Price (\$)
VL491008	8W	805	100.6 lm/w	13.00

### Ölçüler

Standart	a	b	h	d	Ağırlık Weight (kg)	Fiyat Price (\$)
Standart	98	98	32	70	8W	0,11

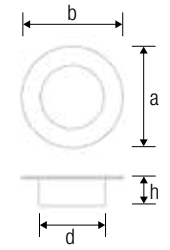

Kod Code	Güç Power	Işık Akısı Lumen	Verimlilik Efficiency	Fiyat Price (\$)
VL491012	12W	1.204	100.3 lm/w	15.00

### Ölçüler

Standart	a	b	h	d	Ağırlık Weight (kg)	Fiyat Price (\$)
Standart	120	120	32	90	12W	0,22

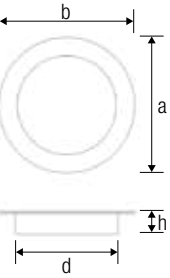

Kod Code	Güç Power	Işık Akısı Lumen	Verimlilik Efficiency	Fiyat Price (\$)
VL491018	18W	1.810	100.5 lm/w	19.50
VL491024	24W	2.408	100.3 lm/w	20.00

### Ölçüler

Standart	a	b	h	d	Ağırlık Weight (kg)	Fiyat Price (\$)
Standart	180	180	32	145	18W	0,24
					24W	0,24

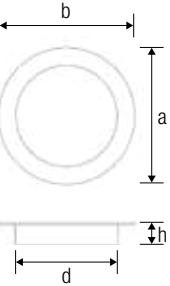



Alüminyum gövde ve çerçeve  
Elektrostatik toz boyalı  
Opal difüzör

Aluminium body and frame  
Electrostatic powder coated  
Opaque diffuser

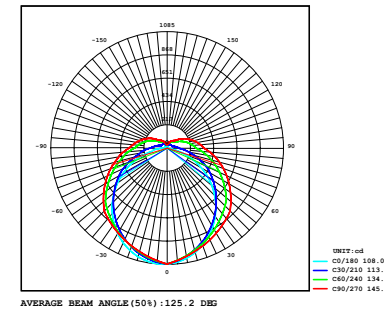

#### Ürün Özellikleri

##### Product Features

IP Koruma Sınıfı / IP Protection Class	: IP 40
Kullanım Şekli / Usage	: Sıva Üstü / Surface Mounted
Işık Kaynağı / Source of Light	: Mid Power LED

#### Elektriksel Özellikleri

##### Electrical Properties

Giriş Gerilimi / Input Voltage	: 220-240 V
Giriş Frekans / Input Frequency	: 50-60 Hz
Max. Gerilim Dayanımı / Max. Voltage Strength	: 2 kV
Sürüş Akımı / Driving Current	: 700 mA
Güç Faktörü / Power Factor	: > 0.95
Renksel Geriverim İndeksi / Color Rendering Index	: > 80

#### Diğer Özellikleri

##### Other Features

Çalışma Sıcaklık Aralığı / Operating Heat Range	: -20°C / +45°C
Darbe Dayanım (IK) / Impact Resistance	: IK05
Led Ömrü / Led Life	: 100.000 saat / hour

#### Renk Sıcaklığı

Kelvin



#### Opsiyonel Özellikler

##### Optional Features

Renk Sıcaklığı / Kelvin	: 3000K - 4000K - 6500K
DALI	: Var / Yes
Sensör / Sensor	: Var / Yes



Kod Code	Güç Power	Işık Akısı Lumen	Verimlilik Efficiency	Fiyat Price (\$)
VL491008-SÜ	8W	805	100.6 lm/w	20.00

#### Ölçüler

Standart	a	b	h	Ağırlık Weight (kg)	Fiyat Price (\$)
Standart	100	100	50	8W	0,20

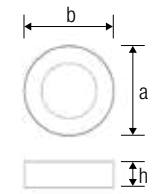

Kod Code	Güç Power	Işık Akısı Lumen	Verimlilik Efficiency	Fiyat Price (\$)
VL491012-SÜ	12W	1.204	100.3 lm/w	23.00

#### Ölçüler

Standart	a	b	h	Ağırlık Weight (kg)	Fiyat Price (\$)
Standart	126	126	52	12W	0,34

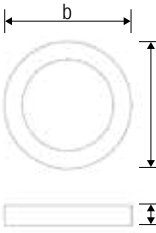

Kod Code	Güç Power	Işık Akısı Lumen	Verimlilik Efficiency	Fiyat Price (\$)
VL491018-SÜ	18W	1.810	100.5 lm/w	27.00
VL491024-SÜ	24W	2.408	100.3 lm/w	28.00

#### Ölçüler

Standart	a	b	h	Ağırlık Weight (kg)	Fiyat Price (\$)
Standart	190	190	54	18W	0,39
				24W	0,39

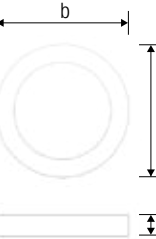



DKP sac gövde  
Elektrostatik toz boyalı  
Opal difüzör

Mild steel body  
Electrostatic powder coated  
Opaque diffuser

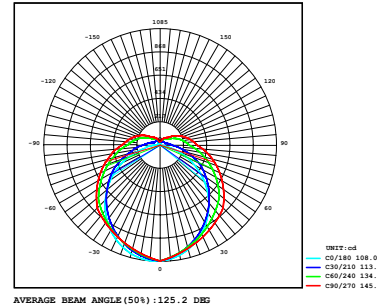

### Ürün Özellikleri

#### Product Features

IP Koruma Sınıfı / IP Protection Class	: IP 40
Kullanım Şekli / Usage	: Sıva Altı / Recessed Mounted
Işık Kaynağı / Source of Light	: Mid Power LED

### Elektriksel Özellikleri

#### Electrical Properties

Giriş Gerilimi / Input Voltage	: 220-240 V
Giriş Frekans / Input Frequency	: 50-60 Hz
Max. Gerilim Dayanımı / Max. Voltage Strength	: 2 kV
Sürüş Akımı / Driving Current	: 700 mA
Güç Faktörü / Power Factor	: > 0.9
Renksel Geriverim İndeksi / Color Rendering Index	: > 80

### Diğer Özellikleri

#### Other Features

Çalışma Sıcaklık Aralığı / Operating Heat Range	: -20°C / +45°C
Darbe Dayanım (IK) / Impact Resistance	: IK02
Led Ömrü / Led Life	: 100.000 saat / hour

### Renk Sıcaklığı

Kelvin



### Opsiyonel Özellikler

#### Optional Features

Renk Sıcaklığı / Kelvin	: 3000K - 4000K - 6500K
DALI	: Var / Yes
Sensör / Sensor	: Var / Yes



Kod Code	Güç Power	Işık Akısı Lumen	Sürücü Driver	Fiyat Price (\$)
VL492008-DOB	8W	446	Dahili / Internal	3.80
VL492108	8W	446	Harici / External	6.50

### Ölçüler

Standart	a	b	h	d
Standart	98	98	28	73

### Ağırlık

Ağırlık Weight (kg)	Fiyat Price (\$)
8W (DOB)	0,04
8W	0,08

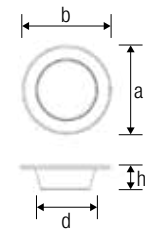

Kod Code	Güç Power	Işık Akısı Lumen	Sürücü Driver	Fiyat Price (\$)
VL492012-DOB	12W	792	Dahili / Internal	4.40
VL492112	12W	792	Harici / External	8.00

### Ölçüler

Standart	a	b	h	d
Standart	120	120	40	91

### Ağırlık

Ağırlık Weight (kg)	Fiyat Price (\$)
12W (DOB)	0,07
12W	0,11

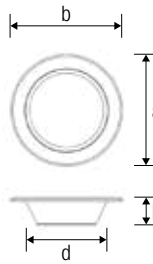

Kod Code	Güç Power	Işık Akısı Lumen	Sürücü Driver	Fiyat Price (\$)
VL492018-DOB	18W	1.188	Dahili / Internal	5.50
VL492118	18W	1.188	Harici / External	9.00

### Ölçüler

Standart	a	b	h	d
Standart	147	147	46	116

### Ağırlık

Ağırlık Weight (kg)	Fiyat Price (\$)
18W (DOB)	0,10
18W	0,14

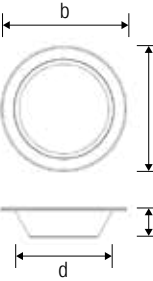

Kod Code	Güç Power	Işık Akısı Lumen	Sürücü Driver	Fiyat Price (\$)
VL492024-DOB	24W	1.584	Dahili / Internal	7.50
VL492124	24W	1.584	Harici / External	12.00

### Ölçüler

Standart	a	b	h	d
Standart	179	179	52	150

### Ağırlık

Ağırlık Weight (kg)	Fiyat Price (\$)
24W (DOB)	0,20
24W	0,24

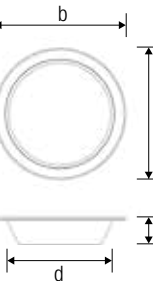



Alüminyum gövde  
Elektrostatik toz boyalı çerçeve  
Opal difüzör

Aluminium body  
Electrostatic powder coated frame  
Opaque diffuser

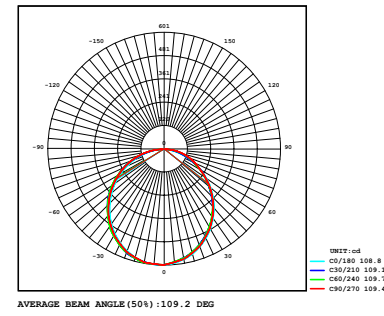

### Ürün Özellikleri

#### Product Features

IP Koruma Sınıfı / IP Protection Class	: IP 40
Kullanım Şekli / Usage	: Sıva Altı / Recessed Mounted
Işık Kaynağı / Source of Light	: Mid Power LED

### Elektriksel Özellikleri

#### Electrical Properties

Giriş Gerilimi / Input Voltage	: 220-240 V
Giriş Frekans / Input Frequency	: 50-60 Hz
Max. Gerilim Dayanımı / Max. Voltage Strength	: 2 kV
Sürüş Akımı / Driving Current	: 700 mA
Güç Faktörü / Power Factor	: > 0.95
Renksel Geriverim İndeksi / Color Rendering Index	: > 80

### Diğer Özellikleri

#### Other Features

Çalışma Sıcaklık Aralığı / Operating Heat Range	: -20°C / +45°C
Darbe Dayanım (IK) / Impact Resistance	: IK08
Led Ömrü / Led Life	: 100.000 saat / hour

### Renk Sıcaklığı

Kelvin



### Opsiyonel Özellikler

#### Optional Features

Renk Sıcaklığı / Kelvin	: 3000K - 4000K - 6500K
DALI	: Var / Yes
Sensör / Sensor	: Var / Yes



Kod Code	Güç Power	Işık Akısı Lumen	Verimlilik Efficiency	Fiyat Price (\$)
VL493008	8W	800	100.0 lm/w	18.50
VL493012	12W	1.200	100.0 lm/w	19.00

### Ölçüler

#### Dimensions (mm)

Standart	a	b	h	d
Standart	115	115	43	90

### Ağırlık

#### Weight (kg)

8W	0,20
12W	0,20

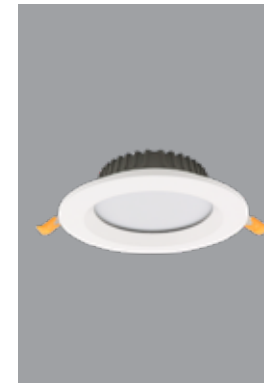
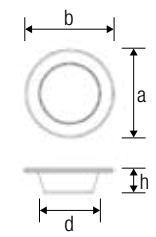

Kod Code	Güç Power	Işık Akısı Lumen	Verimlilik Efficiency	Fiyat Price (\$)
VL493018	18W	1.800	100.0 lm/w	23.50

### Ölçüler

#### Dimensions (mm)

Standart	a	b	h	d
Standart	145	145	45	125

### Ağırlık

#### Weight (kg)

18W	0,30
-----	------

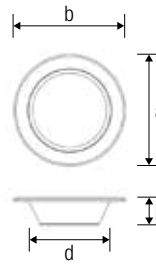

Kod Code	Güç Power	Işık Akısı Lumen	Verimlilik Efficiency	Fiyat Price (\$)
VL493024	24W	2.400	100.0 lm/w	29.00

### Ölçüler

#### Dimensions (mm)

Standart	a	b	h	d
Standart	190	190	55	165

### Ağırlık

#### Weight (kg)

24W	0,40
-----	------

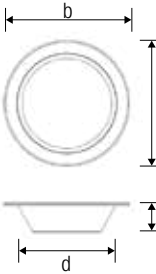

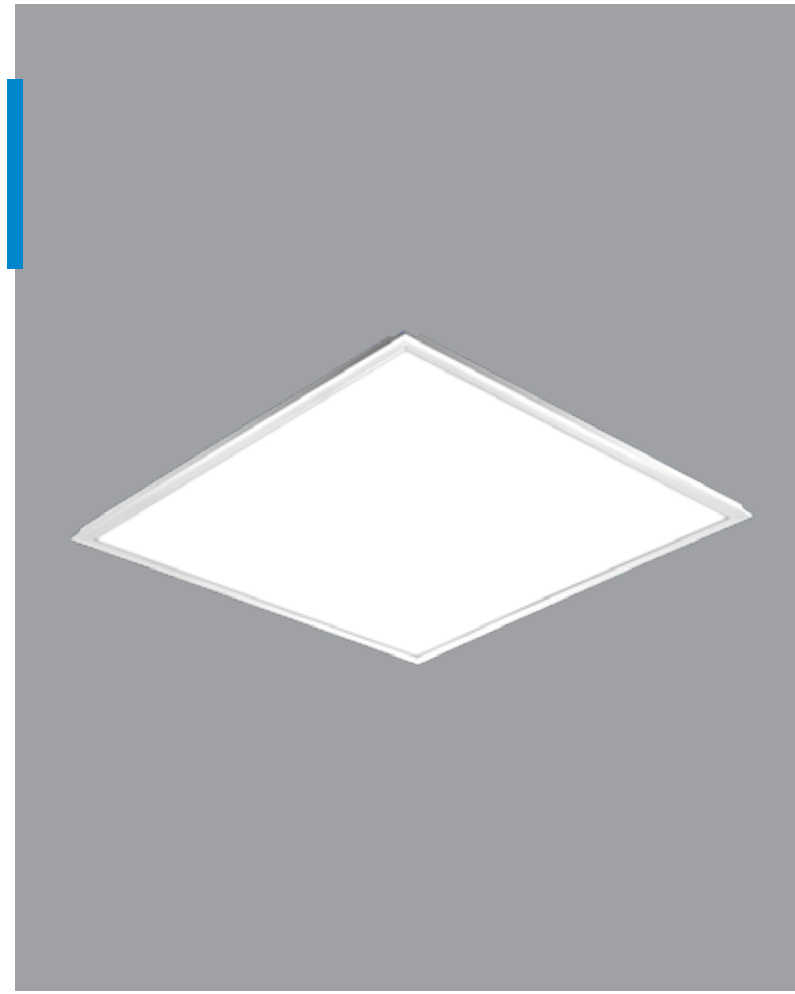

DKP sac gövde  
Alüminyum çerçeve  
Polistiren difüzör

Mild steel body  
Aluminium frame  
Polystyrene diffuser

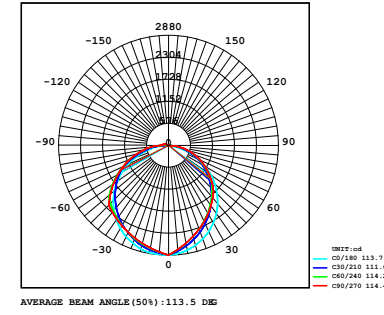

### Ürün Özellikleri

#### Product Features

IP Koruma Sınıfı / IP Protection Class	: IP 40
Kullanım Şekli / Usage	: Sıva Altı / Recessed Mounted
Işık Kaynağı / Source of Light	: Mid Power LED
Optik / Optical	: Lens

### Elektriksel Özellikleri

#### Electrical Properties

Giriş Gerilimi / Input Voltage	: 220-240 V
Giriş Frekans / Input Frequency	: 50-60 Hz
Max. Gerilim Dayanımı / Max. Voltage Strength	: 2 kV
Sürüş Akımı / Driving Current	: 700 mA
Güç Faktörü / Power Factor	: > 0.95
Renksel Geriverim İndeksi / Color Rendering Index	: > 80

### Diğer Özellikleri

#### Other Features

Çalışma Sıcaklık Aralığı / Operating Heat Range	: -20°C / +45°C
Darbe Dayanım (IK) / Impact Resistance	: IK05
Led Ömrü / Led Life	: 100.000 saat / hour

### Renk Sıcaklığı

Kelvin



### Opsiyonel Özellikler

#### Optional Features

Renk Sıcaklığı / Kelvin	: 3000K - 4000K - 6500K
DALI	: Var / Yes
Koridor Fonksiyonlu / Corridor Function	: Var / Yes
Sensör / Sensor	: Var / Yes
Difüzör / Diffuser	: PMMA
Tavan Tipi / Ceiling Type	: Alçıpan Yayı / Clip-in

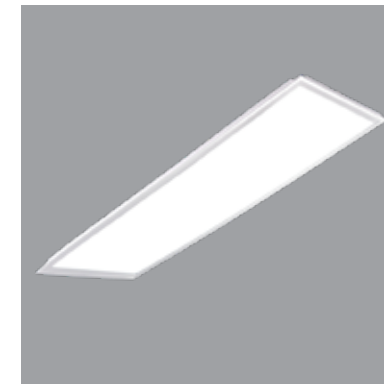
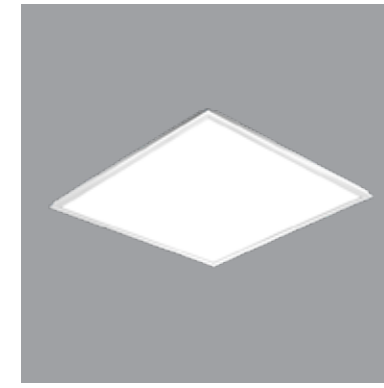
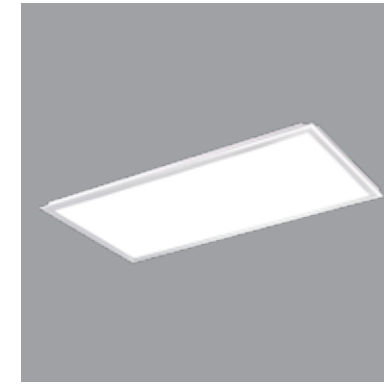
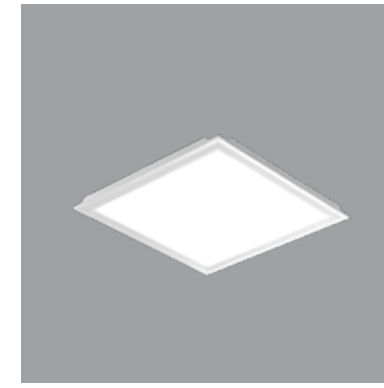

Kod Code	Güç Power	Işık Akısı Lumen	Verimlilik Efficiency	Fiyat Price (\$)
VL468012	12W	1.212	101.0 lm/w	19.00

### Ölçüler

Dimensions (mm)	a	b	h
Standart	300	300	30

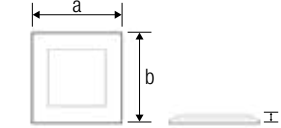

### Ağırlık

Weight (kg)	
12W	0,34

### Opsiyonel

Optional	Adet Piece	Fiyat Price (\$)
Alçıpan Yayı	2	1.80

Kod Code	Güç Power	Işık Akısı Lumen	Verimlilik Efficiency	Fiyat Price (\$)
VL468018	18W	1.823	101.2 lm/w	23.00

### Ölçüler

Dimensions (mm)	a	b	h
Standart	600	300	30

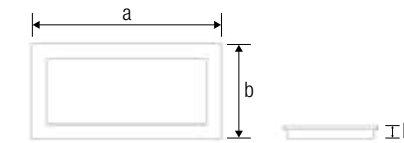

### Ağırlık

Weight (kg)	
18W	0,58

### Opsiyonel

Optional	Adet Piece	Fiyat Price (\$)
Alçıpan Yayı	4	3.60

Kod Code	Güç Power	Işık Akısı Lumen	Verimlilik Efficiency	Fiyat Price (\$)
VL468036	36W	3.881	107.8 lm/w	26.00
VL468045	45W	4.580	101.7 lm/w	27.00

### Ölçüler

Dimensions (mm)	a	b	h
Standart	600	600	30

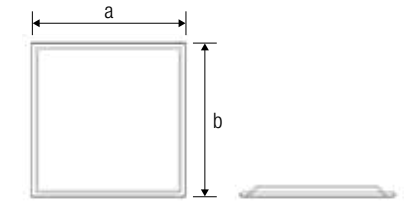

### Ağırlık

Weight (kg)	
36W - 45W	1,02

### Opsiyonel

Optional	Adet Piece	Fiyat Price (\$)
Alçıpan Yayı	4	3.60
Clip-in		3.50

Kod Code	Güç Power	Işık Akısı Lumen	Verimlilik Efficiency	Fiyat Price (\$)
VL468034	34W	3.465	101.9 lm/w	45.00

### Ölçüler

Dimensions (mm)	a	b	h
Standart	1200	300	30

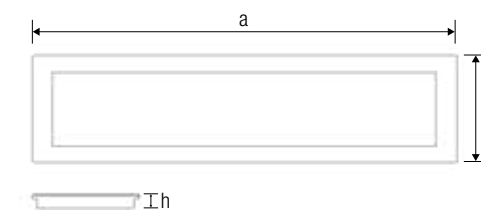

### Ağırlık

Weight (kg)	
34W	1,31

### Opsiyonel

Optional	Adet Piece	Fiyat Price (\$)
Alçıpan Yayı	6	5.50







DKP sac gövde  
DKP sac çerçeve  
Polistiren difüzör

Mild steel body  
Mild steel frame  
Polystyrene diffuser

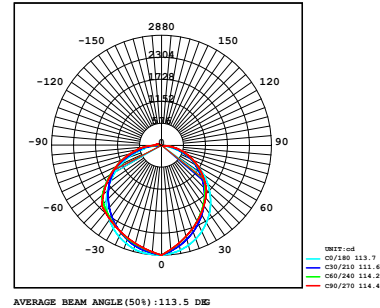

### Ürün Özellikleri

#### Product Features

IP Koruma Sınıfı / IP Protection Class	: IP 40
Kullanım Şekli / Usage	: Sıva Üstü / Surface Mounted
Işık Kaynağı / Source of Light	: Mid Power LED
Optik / Optical	: Lens

### Elektriksel Özellikleri

#### Electrical Properties

Giriş Gerilimi / Input Voltage	: 220-240 V
Giriş Frekans / Input Frequency	: 50-60 Hz
Max. Gerilim Dayanımı / Max. Voltage Strength	: 2 kV
Sürüş Akımı / Driving Current	: 700 mA
Güç Faktörü / Power Factor	: > 0.95
Renk Geriverim İndeksi / Color Rendering Index	: > 80

### Diğer Özellikleri

#### Other Features

Çalışma Sıcaklık Aralığı / Operating Heat Range	: -20°C / +45°C
Darbe Dayanım (IK) / Impact Resistance	: IK05
Led Ömrü / Led Life	: 100.000 saat / hour

### Renk Sıcaklığı

#### Kelvin



### Opsiyonel Özellikler

#### Optional Features

Renk Sıcaklığı / Kelvin	: 3000K - 4000K - 6500K
DALI	: Var / Yes
Koridor Fonksiyonlu / Corridor Function	: Var / Yes
Sensör / Sensor	: Var / Yes
Difüzör / Diffuser	: PMMA

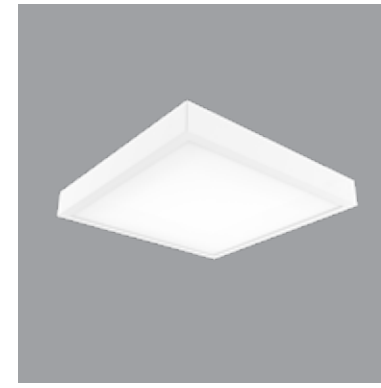

Kod Code	Güç Power	Işık Akısı Lumen	Verimlilik Efficiency	Fiyat Price (\$)
VL468012-SÜ	12W	1.212	101.0 lm/w	33.00

### Ölçüler

#### Dimensions (mm)

Standart	a	b	h
Standart	300	300	38

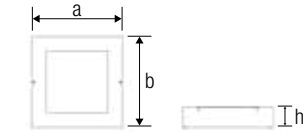

### Ağırlık

#### Weight (kg)

12W	0,55
-----	------

Kod Code	Güç Power	Işık Akısı Lumen	Verimlilik Efficiency	Fiyat Price (\$)
VL468018-SÜ	18W	1.823	101.2 lm/w	40.00

### Ölçüler

#### Dimensions (mm)

Standart	a	b	h
Standart	600	300	38

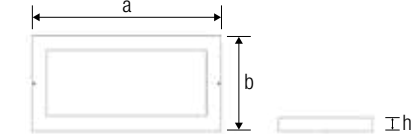

### Ağırlık

#### Weight (kg)

18W	0,86
-----	------

Kod Code	Güç Power	Işık Akısı Lumen	Verimlilik Efficiency	Fiyat Price (\$)
VL468036-SÜ	36W	3.881	107.8 lm/w	42.00
VL468045-SÜ	45W	4.580	101.7 lm/w	43.00

### Ölçüler

#### Dimensions (mm)

Standart	a	b	h
Standart	600	600	38

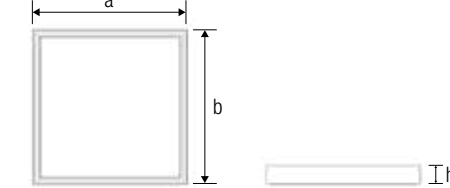

### Ağırlık

#### Weight (kg)

36W - 45W	1,39
-----------	------

Kod Code	Güç Power	Işık Akısı Lumen	Verimlilik Efficiency	Fiyat Price (\$)
VL468034-SÜ	34W	3.465	101.9 lm/w	64.00

### Ölçüler

#### Dimensions (mm)

Standart	a	b	h
Standart	1200	300	38



### Ağırlık

#### Weight (kg)

34W	1,78
-----	------





DKP sac gövde  
DKP sac çerçeve  
Polistiren difüzör

Mild steel body  
Mild steel frame  
Polystyrene diffuser

- 60x60 ürün grubunda ABS çerçeve kullanılmaktadır.
- ABS frame is used in the 60x60 product group.

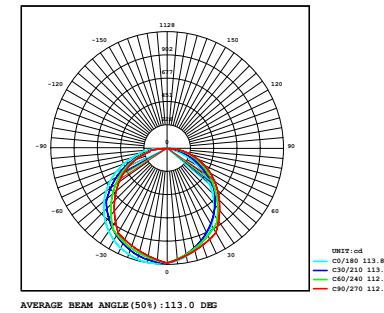

### Ürün Özellikleri

#### Product Features

IP Koruma Sınıfı / IP Protection Class	: IP 40
Kullanım Şekli / Usage	: Sıva Altı / Recessed Mounted
Işık Kaynağı / Source of Light	: Mid Power LED
Optik / Optical	: Tarak kart / Comb PCB

### Elektriksel Özellikleri

#### Electrical Properties

Giriş Gerilimi / Input Voltage	: 220-240 V
Giriş Frekans / Input Frequency	: 50-60 Hz
Max. Gerilim Dayanımı / Max. Voltage Strength	: 2 kV
Sürüş Akımı / Driving Current	: 700 mA
Güç Faktörü / Power Factor	: > 0.95
Renksel Geriverim İndeksi / Color Rendering Index	: > 80

### Diğer Özellikleri

#### Other Features

Çalışma Sıcaklık Aralığı / Operating Heat Range	: -20°C / +45°C
Darbe Dayanım (IK) / Impact Resistance	: IK05
Led Ömrü / Led Life	: 100.000 saat / hour

### Renk Sıcaklığı

Kelvin



### Opsiyonel Özellikler

#### Optional Features

Renk Sıcaklığı / Kelvin	: 3000K - 4000K - 6500K
DALI	: Var / Yes
Koridor Fonksiyonlu / Corridor Function	: Var / Yes
Sensör / Sensor	: Var / Yes
Difüzör / Diffuser	: PMMA
Tavan Tipi / Ceiling Type	: Alçıpan Yayı / Clip-in



Kod Code	Güç Power	Işık Akısı Lumen	Verimlilik Efficiency	Fiyat Price (\$)
VL468011	11W	1.248	113.4 lm/w	29.00

### Ölçüler

Dimensions (mm)	a	b	h
Standart	300	300	70

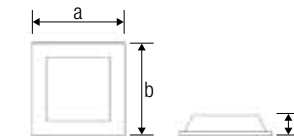

### Ağırlık

Weight (kg)	
11W	0,81

### Opsiyonel

Optional	Adet Piece	Fiyat Price (\$)
Alçıpan Yayı	2	1.80



Kod Code	Güç Power	Işık Akısı Lumen	Verimlilik Efficiency	Fiyat Price (\$)
VL468017	17W	1.930	113.5 lm/w	45.00

### Ölçüler

Dimensions (mm)	a	b	h
Standart	600	300	70

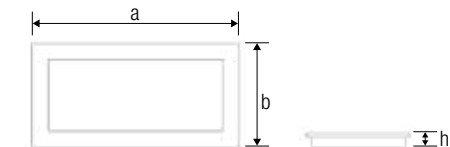

### Ağırlık

Weight (kg)	
17W	2,08

### Opsiyonel

Optional	Adet Piece	Fiyat Price (\$)
Alçıpan Yayı	4	3.60

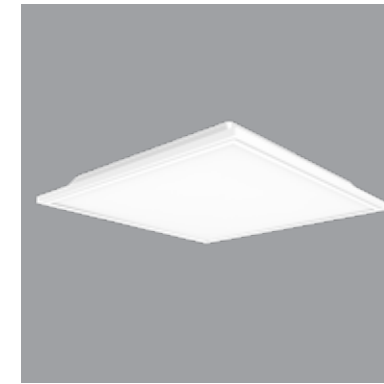

Kod Code	Güç Power	Işık Akısı Lumen	Verimlilik Efficiency	Fiyat Price (\$)
VL468035	35W	4.020	114.8 lm/w	56.00
VL468044	44W	4.684	106.4 lm/w	57.00

### Ölçüler

Dimensions (mm)	a	b	h
Standart	600	600	70

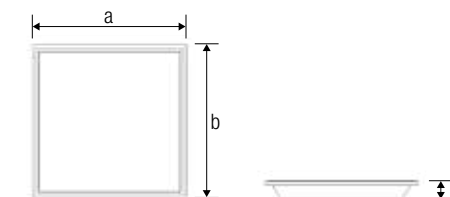

### Ağırlık

Weight (kg)	
35W - 44W	2,30

### Opsiyonel

Optional	Adet Piece	Fiyat Price (\$)
Alçıpan Yayı	4	3.60
Clip-in / Sac çerçeve	5.00 / 3.50	



Kod Code	Güç Power	Işık Akısı Lumen	Verimlilik Efficiency	Fiyat Price (\$)
VL468033	33W	3.570	108.1 lm/w	80.00

### Ölçüler

Dimensions (mm)	a	b	h
Standart	1200	300	70



### Ağırlık

Weight (kg)	
33W	4,56

### Opsiyonel

Optional	Adet Piece	Fiyat Price (\$)
Alçıpan Yayı	6	5.50





DKP sac gövde  
DKP sac çerçeve  
Polistiren difüzör

Mild steel body  
Mild steel frame  
Polystyrene diffuser

- 60x60 ürün grubunda ABS çerçeve kullanılmaktadır.
- ABS frame is used in the 60x60 product group.

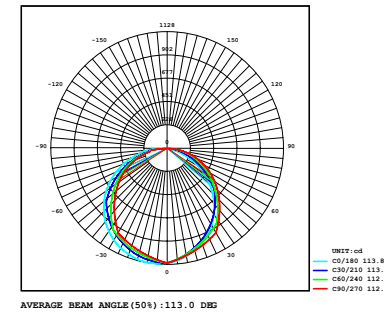

### Ürün Özellikleri

#### Product Features

IP Koruma Sınıfı / IP Protection Class	: IP 40
Kullanım Şekli / Usage	: Sıva Üstü / Surface Mounted
Işık Kaynağı / Source of Light	: Mid Power LED
Optik / Optical	: Tarak kart / Comb PCB

### Elektriksel Özellikleri

#### Electrical Properties

Giriş Gerilimi / Input Voltage	: 220-240 V
Giriş Frekans / Input Frequency	: 50-60 Hz
Max. Gerilim Dayanımı / Max. Voltage Strength	: 2 kV
Sürüş Akımı / Driving Current	: 700 mA
Güç Faktörü / Power Factor	: > 0.95
Renksel Geriverim İndeksi / Color Rendering Index	: > 80

### Diğer Özellikleri

#### Other Features

Çalışma Sıcaklık Aralığı / Operating Heat Range	: -20°C / +45°C
Darbe Dayanım (IK) / Impact Resistance	: IK05
Led Ömrü / Led Life	: 100.000 saat / hour

### Renk Sıcaklığı

#### Kelvin



### Opsiyonel Özellikler

#### Optional Features

Renk Sıcaklığı / Kelvin	: 3000K - 4000K - 6500K
DALI	: Var / Yes
Koridor Fonksiyonlu / Corridor Function	: Var / Yes
Sensör / Sensor	: Var / Yes
Difüzör / Diffuser	: PMMA



Kod Code	Güç Power	Işık Akısı Lumen	Verimlilik Efficiency	Fiyat Price (\$)
VL468011-SÜ	11W	1.248	113.4 lm/w	32.00

### Ölçüler

#### Dimensions (mm)

Standart	a	b	h
Standart	300	300	70

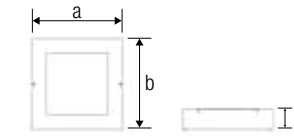

### Ağırlık

#### Weight (kg)

11W	1,35
-----	------



Kod Code	Güç Power	Işık Akısı Lumen	Verimlilik Efficiency	Fiyat Price (\$)
VL468017-SÜ	17W	1.930	113.5 lm/w	52.00

### Ölçüler

#### Dimensions (mm)

Standart	a	b	h
Standart	600	300	70

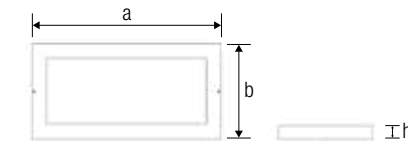

### Ağırlık

#### Weight (kg)

17W	2,87
-----	------



Kod Code	Güç Power	Işık Akısı Lumen	Verimlilik Efficiency	Fiyat Price (\$)
VL468035-SÜ	35W	4.020	114.8 lm/w	62.00
VL468044-SÜ	44W	4.684	106.4 lm/w	63.00

### Ölçüler

#### Dimensions (mm)

Standart	a	b	h
Standart	600	600	70

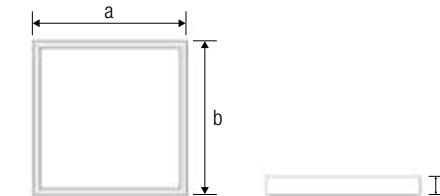

### Ağırlık

#### Weight (kg)

35W - 44W	1,59
-----------	------

### Opsiyonel

#### Optional

Saç çerçeve

### Fiyat

#### Price (\$)

7.00



Kod Code	Güç Power	Işık Akısı Lumen	Verimlilik Efficiency	Fiyat Price (\$)
VL468033-SÜ	33W	3.570	108.1 lm/w	88.00

### Ölçüler

#### Dimensions (mm)

Standart	a	b	h
Standart	1200	300	70

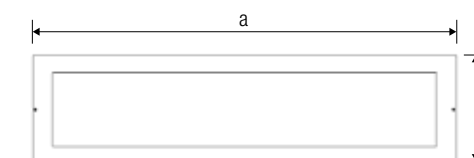

### Ağırlık

#### Weight (kg)

33W	5,07
-----	------





DKP sac gövde  
Temperli cam ve polistiren difüzör

Mild steel body  
Tempered glass and polystyrene diffuser

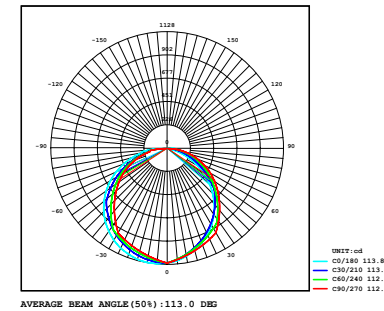

### Ürün Özellikleri

#### Product Features

IP Koruma Sınıfı / IP Protection Class	: IP 65
Kullanım Şekli / Usage	: Sıva Altı / Recessed Mounted
Işık Kaynağı / Source of Light	: Mid Power LED
Optik / Optical	: Tarak kart / Comb PCB

### Elektriksel Özellikleri

#### Electrical Properties

Giriş Gerilimi / Input Voltage	: 220-240 V
Giriş Frekans / Input Frequency	: 50-60 Hz
Max. Gerilim Dayanımı / Max. Voltage Strength	: 2 kV
Sürüş Akımı / Driving Current	: 700 mA
Güç Faktörü / Power Factor	: > 0.95
Renksel Geriverim İndeksi / Color Rendering Index	: > 80

### Diğer Özellikleri

#### Other Features

Çalışma Sıcaklık Aralığı / Operating Heat Range	: -20°C / +45°C
Darbe Dayanım (IK) / Impact Resistance	: IK07
Led Ömrü / Led Life	: 100.000 saat / hour

### Renk Sıcaklığı

Kelvin



### Opsiyonel Özellikler

#### Optional Features

Renk Sıcaklığı / Kelvin	: 3000K - 4000K - 6500K
DALI	: Var / Yes
Koridor Fonksiyonlu / Corridor Function	: Var / Yes
Sensör / Sensor	: Var / Yes

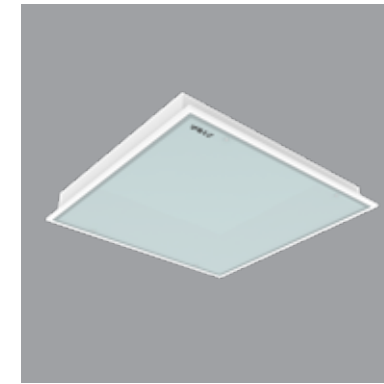

Kod Code	Güç Power	Işık Akısı Lumen	Verimlilik Efficiency	Fiyat Price (\$)
VL467015	15W	1.519	101.3 lm/w	40.00

### Ölçüler

#### Dimensions (mm)

Standart	a	b	h
Standart	347	293	73

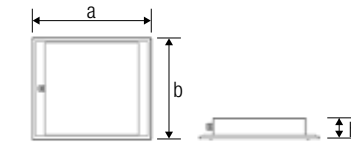

### Ağırlık

#### Weight (kg)

15W	2,05
-----	------

Kod Code	Güç Power	Işık Akısı Lumen	Verimlilik Efficiency	Fiyat Price (\$)
VL467024	24W	2.457	102.4 lm/w	50.00

### Ölçüler

#### Dimensions (mm)

Standart	a	b	h
Standart	595	295	73

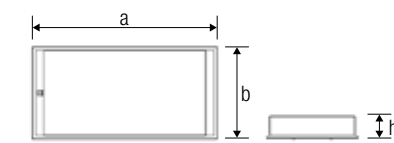

### Ağırlık

#### Weight (kg)

24W	4,20
-----	------

Kod Code	Güç Power	Işık Akısı Lumen	Verimlilik Efficiency	Fiyat Price (\$)
VL467035	35W	3.563	101.8 lm/w	95.00
VL467045	45W	4.518	100.4 lm/w	96.00

### Ölçüler

#### Dimensions (mm)

Standart	a	b	h
Standart	595	595	73

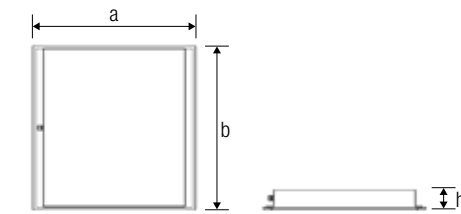

### Ağırlık

#### Weight (kg)

35W - 45W	7,30
-----------	------

Kod Code	Güç Power	Işık Akısı Lumen	Verimlilik Efficiency	Fiyat Price (\$)
VL467034	34W	3.602	105.9 lm/w	120.00

### Ölçüler

#### Dimensions (mm)

Standart	a	b	h
Standart	1195	295	73

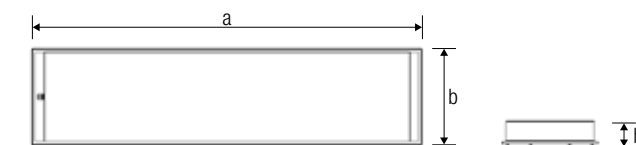

### Ağırlık

#### Weight (kg)

34W	11,74
-----	-------





DKP sac gövde  
Mild steel body

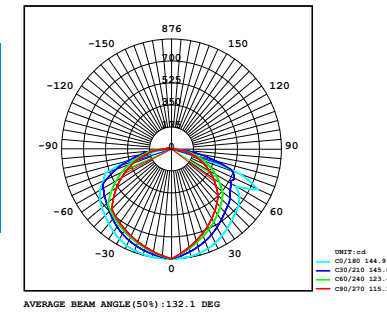

\*Alçıpan yayı fiyata dahil değildir.

Kod Code	Güç Power	Işık Akısı Lumen	Verimlilik Efficiency	Fiyat Price (\$)
VL466135	36W	2.385	66.2 lm/w	110.00
VL466145	45W	2.835	63.0 lm/w	111.00

Ölçüler Dimensions (mm)	a	b	h	Ağırlık Weight (kg)
Standart	600	600	70	36W - 45W 3,75

Opsiyonel Optional	Adet Piece	Fiyat Price (\$)
Alçıpan Yayı	4	3.60

### Ürün Özellikleri

#### Product Features

IP Koruma Sınıfı / IP Protection Class	: IP 20
Kullanım Şekli / Usage	: Sıva Altı / Recessed Mounted
Işık Kaynağı / Source of Light	: Mid Power LED

### Elektriksel Özellikleri

#### Electrical Properties

Giriş Gerilimi / Input Voltage	: 220-240 V
Giriş Frekans / Input Frequency	: 50-60 Hz
Max. Gerilim Dayanımı / Max. Voltage Strength	: 2 kV
Sürüş Akımı / Driving Current	: 700 mA
Güç Faktörü / Power Factor	: > 0.95
Renk Geriverim İndeksi / Color Rendering Index	: > 80

### Diğer Özellikleri

#### Other Features

Çalışma Sıcaklık Aralığı / Operating Heat Range	: -20°C / +45°C
Darbe Dayanım (IK) / Impact Resistance	: IK05
Led Ömrü / Led Life	: 100.000 saat / hour

### Renk Sıcaklığı

Kelvin



### Opsiyonel Özellikler

#### Optional Features

Renk Sıcaklığı / Kelvin	: 3000K - 4000K - 6500K
DALI	: Var / Yes
Koridor Fonksiyonlu / Corridor Function	: Var / Yes
Sensör / Sensor	: Var / Yes





DKP sac gövde  
Temperli cam

Mild steel body  
Tempered glass

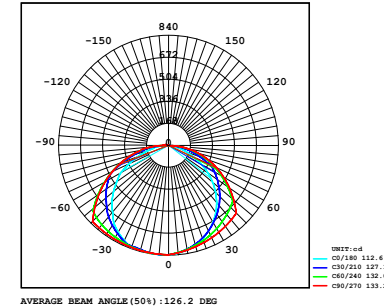

\*Alçıpan yayı fiyata dahil değildir.

Kod Code	Güç Power	Işık Akısı Lumen	Verimlilik Efficiency	Fiyat Price (\$)
VL467135	36W	2.385	66.2 lm/w	148.00
VL467145	45W	2.835	63.0 lm/w	149.00

Ölçüler Dimensions (mm)	a	b	h	Ağırlık Weight (kg)
Standart	600	600	70	36W - 45W 7,39

Opsiyonel Optional	Adet Piece	Fiyat Price (\$)
Alçıpan Yayı	4	3.60

### Ürün Özellikleri

#### Product Features

IP Koruma Sınıfı / IP Protection Class	: IP 65
Kullanım Şekli / Usage	: Sıva Altı / Recessed Mounted
Işık Kaynağı / Source of Light	: Mid Power LED

### Elektriksel Özellikleri

#### Electrical Properties

Giriş Gerilimi / Input Voltage	: 220-240 V
Giriş Frekans / Input Frequency	: 50-60 Hz
Max. Gerilim Dayanımı / Max. Voltage Strength	: 2 kV
Sürüş Akımı / Driving Current	: 700 mA
Güç Faktörü / Power Factor	: > 0.95
Renk Geriverim İndeksi / Color Rendering Index	: > 80

### Diğer Özellikleri

#### Other Features

Çalışma Sıcaklık Aralığı / Operating Heat Range	: -20°C / +45°C
Darbe Dayanım (IK) / Impact Resistance	: IK05
Led Ömrü / Led Life	: 100.000 saat / hour

### Renk Sıcaklığı

Kelvin



### Opsiyonel Özellikler

#### Optional Features

Renk Sıcaklığı / Kelvin	: 3000K - 4000K - 6500K
DALI	: Var / Yes
Koridor Fonksiyonlu / Corridor Function	: Var / Yes
Sensör / Sensor	: Var / Yes





ABS gövde  
Polikarbon cam

ABS body  
Polycarbonate glass

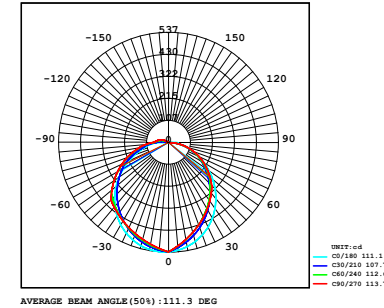

#### Ürün Özellikleri

Product Features

IP Koruma Sınıfı / IP Protection Class	: IP 40
Kullanım Şekli / Usage	: Sıva Üstü / Surface Mounted
Işık Kaynağı / Source of Light	: Mid Power LED

#### Elektriksel Özellikleri

Electrical Properties

Giriş Gerilimi / Input Voltage	: 220-240 V
Giriş Frekans / Input Frequency	: 50-60 Hz
Max. Gerilim Dayanımı / Max. Voltage Strength	: 2 kV
Sürüş Akımı / Driving Current	: 700 mA
Güç Faktörü / Power Factor	: > 0.9
Renk Geriverim İndeksi / Color Rendering Index	: > 80

#### Diğer Özellikleri

Other Features

Çalışma Sıcaklık Aralığı / Operating Heat Range	: -20°C / +45°C
Darbe Dayanım (IK) / Impact Resistance	: IK10
Led Ömrü / Led Life	: 100.000 saat / hour

#### Renk Sıcaklığı

Kelvin



#### Opsiyonel Özellikler

Optional Features

Renk Sıcaklığı / Kelvin	: 3000K - 4000K - 6500K
DALI	: Hayır / No
Sensör / Sensor	: Var / Yes



Kod Code	Güç Power	Işık Akısı Lumen	Açıklama Description	Fiyat Price (\$)
VL810020	20W	2.050	-	10.00
VL811020	20W	2.050	Radar Sensör / Radar Sensored	28.00

#### Ölçüler

Standart	a	b	h
Standart	260	260	66

#### Ağırlık

Weight (kg)

VL810020	0,35
VL811020	0,39

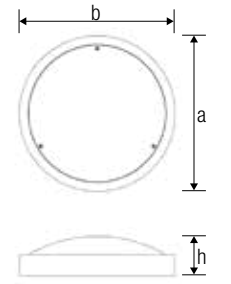

Kod Code	Güç Power	Işık Akısı Lumen	Açıklama Description	Fiyat Price (\$)
VL811120	20W	2.050	Hareket Sensör / Motion Sensored	19.00
VL812020	20W	2.050	Hareket Sensör + Kit (1-3 saat) / Motion Sensored + Emergency (1-3 hour)	31.00

#### Ölçüler

Standart	a	b	h
Standart	260	260	75

#### Ağırlık

Weight (kg)

VL811120	0,40
VL812020	0,47

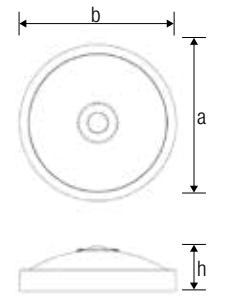

Kod Code	Güç Power	Işık Akısı Lumen	Açıklama Description	Fiyat Price (\$)
VL810030	2xE27	-	-	9.00

#### Ölçüler

Standart	a	b	h
Standart	300	300	85

#### Ağırlık

Weight (kg)

VL810030	0,50
----------	------

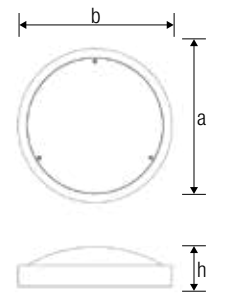

Kod Code	Güç Power	Işık Akısı Lumen	Açıklama Description	Fiyat Price (\$)
VL811130	2xE27	-	Hareket Sensör / Motion Sensored	18.00

#### Ölçüler

Standart	a	b	h
Standart	300	300	93

#### Ağırlık

Weight (kg)

VL811130	0,54
----------	------

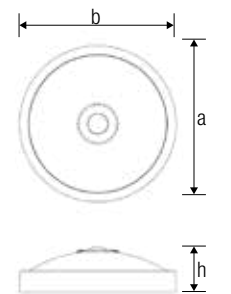



ABS gövde  
Polikarbon cam

ABS body  
Polycarbonate glass

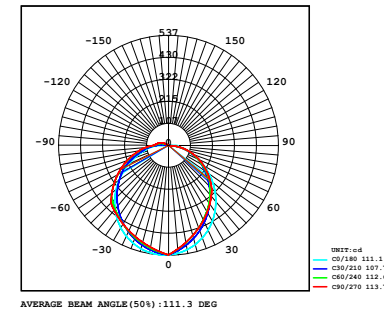

Ürün Özellikleri  
Product Features

IP Koruma Sınıfı / IP Protection Class	: IP 40
Kullanım Şekli / Usage	: Sıva Üstü / Surface Mounted
Işık Kaynağı / Source of Light	: Mid Power LED

Elektriksel Özellikleri  
Electrical Properties

Giriş Gerilimi / Input Voltage	: 220-240 V
Giriş Frekans / Input Frequency	: 50-60 Hz
Max. Gerilim Dayanımı / Max. Voltage Strength	: 2 kV
Sürüş Akımı / Driving Current	: 700 mA
Güç Faktörü / Power Factor	: > 0.9
Renksel Geriverim İndeksi / Color Rendering Index	: > 80

Diğer Özellikleri  
Other Features

Çalışma Sıcaklık Aralığı / Operating Heat Range	: -20°C / +45°C
Darbe Dayanım (IK) / Impact Resistance	: IK10
Led Ömrü / Led Life	: 100.000 saat / hour

Renk Sıcaklığı  
Kelvin



Opsiyonel Özellikler  
Optional Features

Renk Sıcaklığı / Kelvin	: 3000K - 4000K - 6500K
DALI	: Hayır / No
Sensör / Sensor	: Var / Yes



Kod Code	Güç Power	Işık Akısı Lumen	Açıklama Description	Fiyat Price (\$)
VL910010	10W	920	-	10.00
VL911010	10W	920	Radar Sensör / Radar Sensored	28.00

Ölçüler

Standart	a	b	h
Standart	200	200	85

Ağırlık  
Weight (kg)

VL910010	0,27
VL911010	0,21

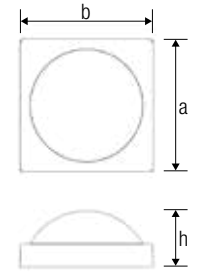

Kod Code	Güç Power	Işık Akısı Lumen	Açıklama Description	Fiyat Price (\$)
VL910020	20W	2.050	-	10.00
VL911020	20W	2.050	Radar Sensör / Radar Sensored	28.00

Ölçüler

Standart	a	b	h
Standart	260	260	66

Ağırlık  
Weight (kg)

VL910020	0,38
VL911020	0,42

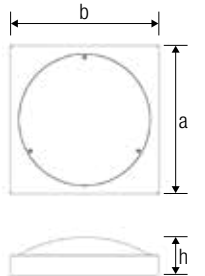

Kod Code	Güç Power	Işık Akısı Lumen	Açıklama Description	Fiyat Price (\$)
VL911220	20W	2.050	Hareket Sensör / Motion Sensored	19.00
VL912020	20W	2.050	Hareket Sensör + Kit (1-3 saat) Motion Sensored + Emergency (1-3 hour)	31.00

Ölçüler

Standart	a	b	h
Standart	260	260	75

Ağırlık  
Weight (kg)

VL911220	0,42
VL912020	0,50

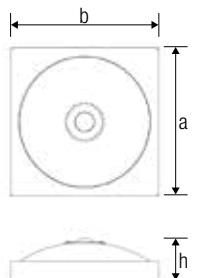





ABS gövde  
Polikarbon cam  
ABS body  
Polycarbonate glass

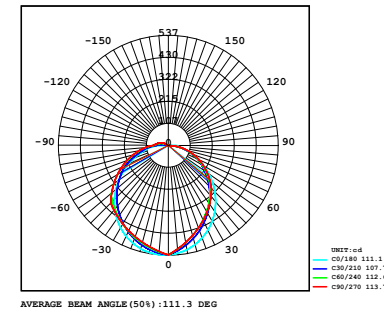

Duvar Tipi Glop / Wall Type Glop



Duvar Tipi Glop / Wall Type Glop

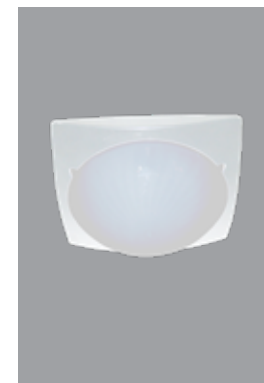

Tavan Tipi Glop / Ceiling Type Glop

Kod Code	Güç Power	Işık Akısı Lumen	Açıklama Description	Fiyat Price (\$)
VL710010	10W	750	-	18.00
VL710110	10W	750	Radar Sensör / Radar Sensored	35.00

Ölçüler Dimensions (mm)	a	b	h
Standart	260	160	90

Ağırlık Weight (kg)	Fiyat Price (\$)
VL710010	0,35
VL710110	0,37

Kod Code	Güç Power	Işık Akısı Lumen	Açıklama Description	Fiyat Price (\$)
VL710210	10W	785	-	18.00
VL710310	10W	785	Radar Sensör / Radar Sensored	35.00

Ölçüler Dimensions (mm)	a	b	h
Standart	262	162	90

Ağırlık Weight (kg)	Fiyat Price (\$)
VL710210	0,35
VL710310	0,37

Kod Code	Güç Power	Işık Akısı Lumen	Açıklama Description	Fiyat Price (\$)
VL710420	20W	2.050	-	26.00
VL710520	20W	2.050	Radar Sensör / Radar Sensored	43.00

Ölçüler Dimensions (mm)	a	b	h
Standart	267	267	105

Ağırlık Weight (kg)	Fiyat Price (\$)
VL710420	0,54
VL710520	0,56

#### Ürün Özellikleri Product Features

IP Koruma Sınıfı / IP Protection Class	: IP 65
Kullanım Şekli / Usage	: Sıva Üstü / Surface Mounted
Işık Kaynağı / Source of Light	: Mid Power LED

#### Elektriksel Özellikleri Electrical Properties

Giriş Gerilimi / Input Voltage	: 220-240 V
Giriş Frekans / Input Frequency	: 50-60 Hz
Max. Gerilim Dayanımı / Max. Voltage Strength	: 2 kV
Sürüş Akımı / Driving Current	: 700 mA
Güç Faktörü / Power Factor	: > 0.9
Renksel Geriverim İndeksi / Color Rendering Index	: > 80

#### Diğer Özellikleri Other Features

Çalışma Sıcaklık Aralığı / Operating Heat Range	: -20°C / +45°C
Darbe Dayanım (IK) / Impact Resistance	: IK10
Led Ömrü / Led Life	: 100.000 saat / hour

#### Renk Sıcaklığı Kelvin



#### Opsiyonel Özellikler Optional Features

Renk Sıcaklığı / Kelvin	: 3000K - 4000K - 6500K
DALI	: Hayır / No
Sensör / Sensor	: Var / Yes



Alüminyum gövde  
Elektrostatik toz boyalı çerçeve  
Reflektör + cam

Aluminium body  
Electrostatic powder coated frame  
Reflector + glass

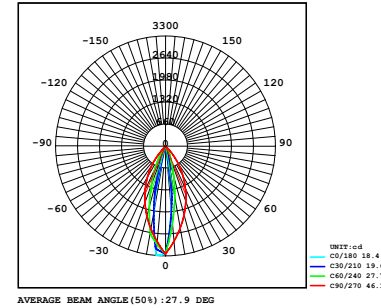

### Ürün Özellikleri

#### Product Features

IP Koruma Sınıfı / IP Protection Class	: IP 40
Kullanım Şekli / Usage	: Sıva Altı / Recessed Mounted
Işık Kaynağı / Source of Light	: COB LED

### Elektriksel Özellikleri

#### Electrical Properties

Giriş Gerilimi / Input Voltage	: 220-240 V
Giriş Frekans / Input Frequency	: 50-60 Hz
Max. Gerilim Dayanımı / Max. Voltage Strength	: 2 kV
Sürüş Akımı / Driving Current	: 700 mA
Güç Faktörü / Power Factor	: > 0.9
Renksel Geriverim İndeksi / Color Rendering Index	: > 80

### Diğer Özellikleri

#### Other Features

Çalışma Sıcaklık Aralığı / Operating Heat Range	: -20°C / +45°C
Darbe Dayanım (IK) / Impact Resistance	: IK05
Led Ömrü / Led Life	: 60.000 saat / hour

### Renk Sıcaklığı

Kelvin



### Opsiyonel Özellikler

#### Optional Features

Renk Sıcaklığı / Kelvin	: 3000K - 4000K - 6500K
DALI	: Var / Yes
Sensör / Sensor	: Var / Yes



Kod Code	Güç Power	Işık Akısı Lumen	Verimlilik Efficiency	Fiyat Price (\$)
VL480008	8W	600	75.5 lm/w	14.50

### Ölçüler

#### Dimensions (mm)

Standart	a	b	h
Standart	108	108	70

### Ağırlık

#### Weight (kg)

Standart	8W	0,30
----------	----	------

### Delik Ölçüsü

#### Holse Size (mm)

Standart	90
----------	----

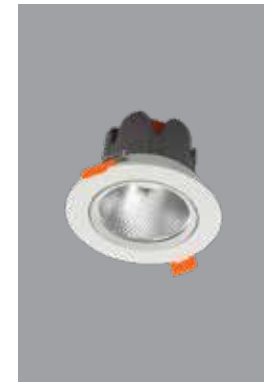

Kod Code	Güç Power	Işık Akısı Lumen	Verimlilik Efficiency	Fiyat Price (\$)
VL480015	15W	1.200	80.0 lm/w	19.00
VL480020	20W	1.500	75.0 lm/w	22.00

### Ölçüler

#### Dimensions (mm)

Standart	a	b	h
Standart	138	138	80

### Ağırlık

#### Weight (kg)

Standart	15W - 20W	0,45
----------	-----------	------

### Delik Ölçüsü

#### Holse Size (mm)

Standart	120
----------	-----



Kod Code	Güç Power	Işık Akısı Lumen	Verimlilik Efficiency	Fiyat Price (\$)
VL480030	30W	2.250	75.0 lm/w	32.00

### Ölçüler

#### Dimensions (mm)

Standart	a	b	h
Standart	160	160	90

### Ağırlık

#### Weight (kg)

Standart	30W	0,30
----------	-----	------

### Delik Ölçüsü

#### Holse Size (mm)

Standart	140
----------	-----



Alüminyum gövde  
Elektrostatik toz boyalı çerçeve  
Reflektör + cam

Aluminium body  
Electrostatic powder coated frame  
Reflector + glass

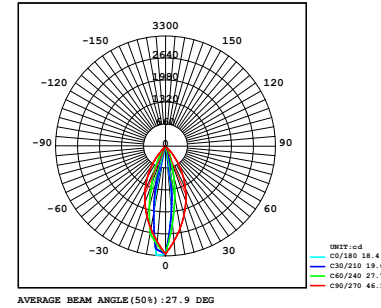

#### Ürün Özellikleri

##### Product Features

IP Koruma Sınıfı / IP Protection Class	: IP 40
Kullanım Şekli / Usage	: Sıva Altı / Recessed Mounted
Işık Kaynağı / Source of Light	: COB LED

#### Elektriksel Özellikleri

##### Electrical Properties

Giriş Gerilimi / Input Voltage	: 220-240 V
Giriş Frekans / Input Frequency	: 50-60 Hz
Max. Gerilim Dayanımı / Max. Voltage Strength	: 2 kV
Sürüş Akımı / Driving Current	: 700 mA
Güç Faktörü / Power Factor	: > 0.9
Renksel Geriverim İndeksi / Color Rendering Index	: > 80

#### Diğer Özellikleri

##### Other Features

Çalışma Sıcaklık Aralığı / Operating Heat Range	: -20°C / +45°C
Darbe Dayanım (IK) / Impact Resistance	: IK05
Led Ömrü / Led Life	: 60.000 saat / hour

#### Renk Sıcaklığı

Kelvin



#### Opsiyonel Özellikler

##### Optional Features

Renk Sıcaklığı / Kelvin	: 3000K - 4000K - 6500K
DALI	: Var / Yes
Sensör / Sensor	: Var / Yes



Kod Code	Güç Power	Işık Akısı Lumen	Verimlilik Efficiency	Fiyat Price (\$)
VL470015	15W	1.200	80.0 lm/w	20.00

#### Ölçüler

Dimensions (mm)

	a	b	h
Standart	120	120	70

#### Ağırlık

Weight (kg)

Standart	15W	0,30
----------	-----	------

#### Delik Ölçüsü

Hole Size (mm)

Standart	90 x 90
----------	---------



Kod Code	Güç Power	Işık Akısı Lumen	Verimlilik Efficiency	Fiyat Price (\$)
VL470030	30W	3.412	113.7 lm/w	39.00

#### Ölçüler

Dimensions (mm)

	a	b	h
Standart	120	230	70

#### Ağırlık

Weight (kg)

Standart	30W	0,60
----------	-----	------

#### Delik Ölçüsü

Hole Size (mm)

Standart	90 x 200
----------	----------



Kod Code	Güç Power	Işık Akısı Lumen	Verimlilik Efficiency	Fiyat Price (\$)
VL470045	45W	4.627	102.8 lm/w	59.00

#### Ölçüler

Dimensions (mm)

	a	b	h
Standart	120	340	70

#### Ağırlık

Weight (kg)

Standart	45W	0,90
----------	-----	------

#### Delik Ölçüsü

Hole Size (mm)

Standart	90 x 300
----------	----------



ABS gövde  
Polikarbon cam

ABS body  
Polycarbonate glass



Kod Code	Güç Power	Açıklama Description	Fiyat Price (\$)
VL360118	1x18W	LED Tube	14.00
VL360136	1x36W	LED Tube	23.00
VL360158	1x58W	LED Tube	57.00

Ölçüler Dimensions (mm)	a	b	h	Ağırlık Weight (kg)	
				1x18W	1x36W
1x18W	675	80	85	0,75	
1x36W	1250	80	85	1,20	
1x58W	1550	80	85	2,18	

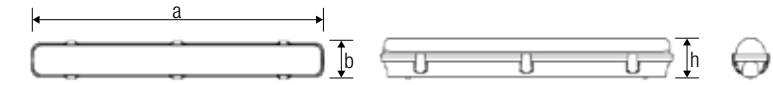

Kod Code	Güç Power	Açıklama Description	Fiyat Price (\$)
VL360218	2x18W	LED Tube	18.50
VL360236	2x36W	LED Tube	31.00
VL360258	2x58W	LED Tube	67.00

Ölçüler Dimensions (mm)	a	b	h	Ağırlık Weight (kg)	
				2x18W	2x36W
2x18W	675	120	85	0,95	
2x36W	1250	120	85	2,00	
2x58W	1550	120	85	2,50	

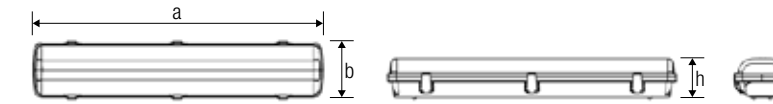

#### Ürün Özellikleri Product Features

IP Koruma Sınıfı / IP Protection Class	: IP 65
Kullanım Şekli / Usage	: Sıva Üstü / Surface Mounted
Işık Kaynağı / Source of Light	: LED Tube

#### Elektriksel Özellikleri Electrical Properties

Giriş Gerilimi / Input Voltage	: 220-240 V
Giriş Frekansı / Input Frequency	: 50-60 Hz
Koruma Sınıfı / Protection Class	: Sınıf 1 / Class 1

#### Diğer Özellikleri Other Features

Çalışma Sıcaklık Aralığı / Operating Heat Range	: -20°C / +45°C
Darbe Dayanım (IK) / Impact Resistance	: IK09
Duy / Bulb Holder	: T8

#### Opsiyonel Özellikler Optional Features

Koruma Sınıfı / Protection Class	: Sınıf 2 / Class 2
----------------------------------	---------------------

**PROTON**

LED IP40

6W  
510 lm  
220-240 V  
50-60 Hz  
20°C / +45°C  
Kg :0,08

3000K  
4000K  
6500K

VL202106 6 W 666 lm 327 x 30 x 37 14.00 \$

**PROTON**

LED IP40

12W  
1200 lm  
220-240 V  
50-60 Hz  
20°C / +45°C  
Kg :0,12

3000K  
4000K  
6500K

VL202112 12 W 1320 lm 602 x 30 x 37 22.00 \$

**Acil Durum Kiti (1 saat)**  
Emergency Kit (1 hour)

VL111001 21.00 \$

**Acil Durum Kiti (3 saat)**  
Emergency Kit (3 hour)

VL111003 24.00 \$

**PUNTO**

YENİ IP65

E27 Duy  
220-240 V  
50-60 Hz  
20°C / +45°C

VL203001 E27 3.70 \$

**PUNTO**

YENİ IP65

E27 Duy  
220-240 V  
50-60 Hz  
20°C / +45°C

VL203002 E27 44.00 \$

**360° Hareket Sensörü**  
360° Motion Sensor

Sıva üstü  
Surface Mounted

VL112001 16.00 \$

**360° Hareket Sensörü**  
360° Motion Sensor

Sıva altı  
Recessed Mounted

VL112002 16.00 \$

**MİRA APLİK**

LED IP65

3000K  
4000K  
6500K

220-240 V  
50-60 Hz  
20°C / +45°C  
Kg :0,91

VL20010 10 W 1000 lm 100 x 100 x 100 27.00 \$  
VL20020 20 W 2000 lm 100 x 100 x 100 29.00 \$

**MİRA APLİK**

LED IP65

3000K  
4000K  
6500K

220-240 V  
50-60 Hz  
20°C / +45°C  
Kg :1,50

VL20210 2x10 W 2000 lm 100 x 100 x 200 45.00 \$  
VL20220 2x20 W 4000 lm 100 x 100 x 200 48.00 \$

**Radar Sensörü**  
Radar Sensor

Zaman ayarlı  
Timed

VL112003 16.00 \$

**Mini Sensörü**  
Mini Sensor

VL112004 16.00 \$

**MİRA V2 APLİK**

LED IP40

3000K  
4000K  
6500K

7W  
500 lm  
220-240 V  
50-60 Hz  
20°C / +45°C  
Kg :0,12

VL202007 7 W 500 lm 350 x 250 x 120 25.00 \$

**ARTEMİS**

YENİ IP40

E27 Duy  
220-240 V  
50-60 Hz  
20°C / +45°C

VL572027 E27 SORUNUZ

**LED Sürücü**  
LED Driver

Yavuz Marka

VL114050 50W Yavuz Driver 10.50 \$

**Busbar Ayağı**  
Busbar Support

VL113001 10.00 \$

**YENİ**

2x15W Sac Gövde Acil Aydınlatma

## ACİL AYDINLATMA ARMATÜRÜ EMERGENCY LIGHTING LUMINAIRE



**IP20**  
2x15W Acil Aydınlatma

✓ Sac gövde  
Sheet body

✓ 3 saat çalışma  
3 hours of work

✓ Hareketli başlık  
Moving head

- 180 derece yön ayarlı LED far
- SMD Power LED uygulaması
- Uzun LED ömrü (30.000 saat)
- Anahtarlanmayan fazın kesilmesiyle devreye girme
- Acil durumda 3 saat çalışma süresi
- Yeşil LED'li batarya şarj göstergesi
- Acil durum test butonu
- Bakım gerektirmeyen Kurşun Asit Akü
- Akü aşırı şarj ve deşarj koruması
- Sabit gerilimli, akım korumalı şarj devresi
- Duvara montaj imkânı
- Acil durum far on - off anahtarı
- Elektrostatik toz boyalı sac gövde
- İsteğe bağlı 110 VAC uyumluluğu



**VL916015**    **2x15W**    **190\$**

## ACİL YÖNLENDİRME ARMATÜRÜ EMERGENCY DIRECTION LUMINAIRE



Yönlendirme Etiketleri Seçim Tablosu  
Routing Label Selection Chart

EXIT ÇIKIŞ VL916001	ÇIKIŞ EXIT VL916002	ÇIKIŞ EXIT VL916003	EXIT ÇIKIŞ VL916004
ACİL ÇIKIŞ VL916005	ACİL ÇIKIŞ VL916006		

- Alüminyum gövde
- Polikarbon köşe
- SMD LED uygulaması
- Acil durum test butonu
- Yeşil LED'li batarya şarj göstergesi
- Tavana ve asma tavana uygulama

IP20 220-240 V 50-60 Hz

**3W** Acil Çıkış (3 saat) / Emergency Exit (3 hour)    **18,00\$**

## ACİL YÖNLENDİRME ARMATÜRÜ EMERGENCY DIRECTION LUMINAIRE



Yönlendirme Etiketleri Seçim Tablosu  
Routing Label Selection Chart

EXIT VL917001	EXIT VL917002	EXIT VL917003	EXIT VL917004	EXIT VL917005	EXIT VL917006	EXIT VL917007
ÇIKIŞ VL917011	ÇIKIŞ VL917012	ÇIKIŞ VL917013	ÇIKIŞ VL917014	ÇIKIŞ VL917015	ÇIKIŞ VL917016	ÇIKIŞ VL917017
EXIT ÇIKIŞ VL917021	EXIT ÇIKIŞ VL917022	EXIT ÇIKIŞ VL917023	EXIT ÇIKIŞ VL917024	EXIT ÇIKIŞ VL917025	EXIT ÇIKIŞ VL917026	EXIT ÇIKIŞ VL917027
ACİL ÇIKIŞ VL917031	ACİL ÇIKIŞ VL917032	ACİL ÇIKIŞ VL917033	ACİL ÇIKIŞ VL917034	ACİL ÇIKIŞ VL917035	ACİL ÇIKIŞ VL917036	ACİL ÇIKIŞ VL917037
EXIT VL917041	EXIT VL917042	EXIT VL917043	EXIT VL917044	EXIT VL917045		
EXIT VL917046	EXIT VL917047	EXIT VL917048	EXIT VL917049	EXIT VL917050		

- Tek veya çift yüzü
- Polikarbon gövde
- Yönlendirme işareti etiketli şeffaf pleksiglas
- SMD LED uygulaması
- Yüksek sıcaklığa dayanıklı
- Batarya aşırı şarj ve deşarj koruması
- Tavana, duvara veya asma tavana uygulama

IP20 220-240 V 50-60 Hz

**3W** Acil Çıkış (3 saat) / Emergency Exit (3 hour)    **19,50\$**

# SOLAR AYDINLATMA

Solar aydınlatma sistemleri, aydınlatma için ihtiyaç olan enerjiyi güneşten alan ürünlerdir. Güneş enerjisi ile çalışan lambalar sayesinde aydınlatma ürünlerini prize takmanız gerekmez diğer bir deyişle elektrik enerjisine ihtiyacınız olmaz.

Solar lighting systems are products that take the energy needed for lighting from the sun. Thanks to the lamps working with solar energy, you do not need to plug the lighting products into the socket, in other words, you do not need electrical energy.



Alüminyum enjeksiyon gövde  
Elektrostatik toz boyalı  
Polikarbon modül lens  
Monokristal solar panel

Aluminium injection body  
Electrostatic powder coated  
Polycarbonate module lens  
Monocrystalline solar panel

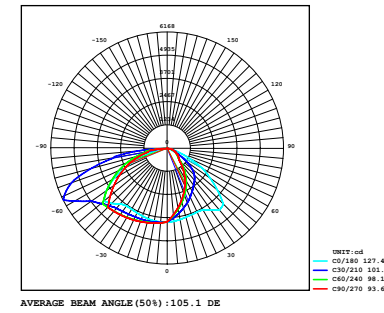

### Ürün Özellikleri

#### Product Features

IP Koruma Sınıfı / IP Protection Class	: IP 66
Kullanım Şekli / Usage	: Direk Montaj / Pole Mounted
Işık Kaynağı / Source of Light	: Mid Power LED
Sensör / Sensör	: Var / Yes

### Diğer Özellikleri

#### Other Features

Çalışma Sıcaklık Aralığı / Operating Heat Range	: -20°C / +45°C
Darbe Dayanım (IK) / Impact Resistance	: IK10
Led Ömrü / Led Life	: 100.000 saat / hour

### Opsiyonel Özellikler

#### Optional Features

Renk Sıcaklığı / Kelvin	: 3000K - 4000K - 6500K
DALI	: Var / Yes

### Renk Sıcaklığı

Kelvin



Kod Code	Güç Power	Işık Akısı Lumen	Ağırlık Weight (kg)	Fiyat Price (\$)
VL801050	50W	1.000	5,50	265.00
VL801100	100W	2.000	6,00	270.00
VL801150	150W	3.000	6,00	340.00

### Ölçüler

#### Dimensions (mm)

	a	b	h
Standart	382	178	225

### Konsol

#### Console (mm)

Haraketli /Sliding	Ø64
--------------------	-----

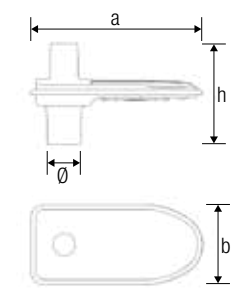

### Haraketli Konsol

#### Moveable console







ABS gövde  
Polikarbon modül lens

ABS body  
Polycarbonate module lens

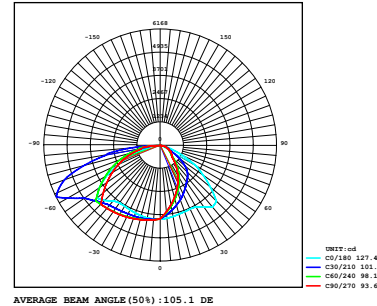

**Ürün Özellikleri**  
Product Features

IP Koruma Sınıfı / IP Protection Class	: IP 66
Kullanım Şekli / Usage	: Direk Montaj / Pole Mounted
Işık Kaynağı / Source of Light	: Mid Power LED
Sensör / Sensör	: Var / Yes

**Diğer Özellikleri**  
Other Features

Çalışma Sıcaklık Aralığı / Operating Heat Range	: -20°C / +45°C
Darbe Dayanım (IK) / Impact Resistance	: IK09
Led Ömrü / Led Life	: 100.000 saat / hour

**Opsiyonel Özellikler**  
Optional Features

Renk Sıcaklığı / Kelvin	: 3000K - 4000K - 6500K
DALI	: Yok / No

**Renk Sıcaklığı**  
Kelvin



Kod Code	Güç Power	Işık Akısı Lumen	Ağırlık Weight (kg)	Fiyat Price (\$)
VL802050	50W	1.000	2,20	95.00
VL802100	100W	2.000	2,40	100.00

**Ölçüler**

Dimensions (mm)	a	b	h
Standart	530	220	64

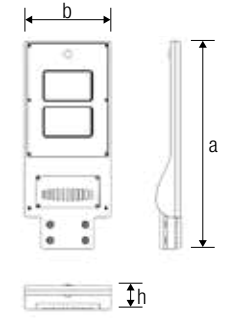

Kod Code	Güç Power	Işık Akısı Lumen	Ağırlık Weight (kg)	Fiyat Price (\$)
VL802150	150W	3.000	3,20	135.00

**Ölçüler**

Dimensions (mm)	a	b	h
Standart	630	220	64

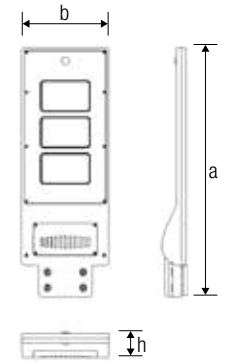

# EX-PROOF AYDINLATMA EX-PROOF LIGHTING

İş güvenliğinin sağlanabilmesi için, bazı tesislerde diğerlerinden farklı olarak özel önlemler almak gerekebilir. Patlayıcı maddelerin bulunduğu veya patlamalara sebep olacak durumların oluşabileceği ortamlarda, kıvılcım ve ark engelleyici elektrikli aletler kullanılmalıdır. Ex-proof olarak tanımlanan ürünler, patlamaya karşı koruma sağlar. Patlama tehlikesi bulunan ortamların aydınlatılmasında ex-proof armatürler kullanılarak güvenli bir çalışma ortamı sunulur. Ex-proof ürünlerin ATEX (ATmosphere EXplosive) sertifikalı olma zorunluluğu vardır. Yangını ve patlamaları önleyici tedbirler alınarak uluslararası iş güvenliği ve işçi sağlığı kurallarının uygulanması esas alınmıştır.

In order to ensure occupational safety, it may be necessary to take special precautions in some facilities, unlike others. In environments where explosive materials are present or situations that may cause explosions may occur, spark and arc preventer electrical tools should be used. Products defined as ex-proof provide protection against explosion. A safe working environment is provided by using ex-proof luminaires in the lighting of explosion-hazardous environments. Ex-proof products have to be ATEX (ATmosphere EXplosive) certified. It is based on the implementation of international occupational safety and worker health rules by taking measures to prevent fire and explosions.

Gaz patlama koruması / Gas explosion protection : ZONE 2



Polikarbon gövde ve opal cam  
Polikarbon yekpare gövde  
Alüminyum kapak

Polycarbonate body and opaque glass  
Polycarbonate monolithic body  
Aluminium cover

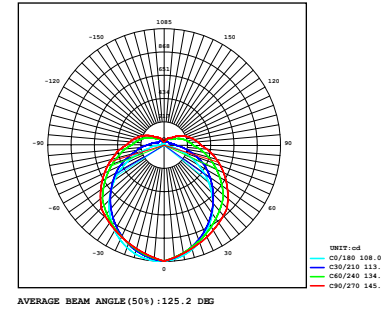

Toz patlama koruması / Dust explosion protection : ZONE 22

#### Ürün Özellikleri

##### Product Features

IP Koruma Sınıfı / IP Protection Class	: IP 66
Kullanım Şekli / Usage	: Sıva Üstü / Surface Mounted
Işık Kaynağı / Source of Light	: Mid Power LED

#### Elektriksel Özellikleri

##### Electrical Properties

Giriş Gerilimi / Input Voltage	: 220-240 V
Giriş Frekans / Input Frequency	: 50-60 Hz
Max. Gerilim Dayanımı / Max. Voltage Strength	: 2 kV
Sürüş Akımı / Driving Current	: 700 mA
Güç Faktörü / Power Factor	: > 0.95
Renksel Geriverim İndeksi / Color Rendering Index	: > 80

#### Diğer Özellikleri

##### Other Features

Çalışma Sıcaklık Aralığı / Operating Heat Range	: -20°C / +50°C
Darbe Dayanım (IK) / Impact Resistance	: IK10
Led Ömrü / Led Life	: 100.000 saat / hour

#### Renk Sıcaklığı

Kelvin



#### Opsiyonel Özellikler

##### Optional Features

Renk Sıcaklığı / Kelvin	: 3000K - 4000K - 6500K
DALI	: Var / Yes
Sensör / Sensor	: Var / Yes



Kod Code	Güç Power	Işık Akısı Lumen	Verimlilik Efficiency	Fiyat Price (\$)
VL569020-EX	20W	2.010	100.5 lm/w	95.00
VL569030-EX	30W	3.015	100.5 lm/w	100.00

#### Ölçüler

Standart	a	b	h
Standart	687	130	116

#### Ağırlık

Standart	Ağırlık Weight (kg)
20W	1,65
30W	1,75



Kod Code	Güç Power	Işık Akısı Lumen	Verimlilik Efficiency	Fiyat Price (\$)
VL569040-EX	40W	4.065	101.6 lm/w	140.00
VL569050-EX	50W	5.040	100.8 lm/w	145.00

#### Ölçüler

Standart	a	b	h
Standart	1293	130	116

#### Ağırlık

Standart	Ağırlık Weight (kg)
40W	3,25
50W	3,40

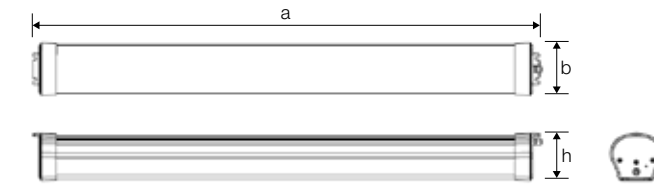

## Gaz patlama koruması / Gas explosion protection : ZONE 2



## Toz patlama koruması / Dust explosion protection : ZONE 22

Polikarbon gövde ve Şeffaf cam  
Polikarbon yekpare gövde  
Alüminyum kapak

Polycarbonate body and transparent glass  
Polycarbonate monolithic body  
Aluminium cover



Kod Code	Güç Power	Ağırlık Weight (kg)	Fiyat Price (\$)
VL569118-EX	1x18W	1.60	115.00
VL569218-EX	2x18W	1.60	115.00

## Ölçüler

Dimensions (mm)	a	b	h
Standart	687	130	116



Kod Code	Güç Power	Ağırlık Weight (kg)	Fiyat Price (\$)
VL569136-EX	1x36W	3.20	140.00
VL569236-EX	2x36W	3.20	140.00

## Ölçüler

Dimensions (mm)	a	b	h
Standart	1293	130	116

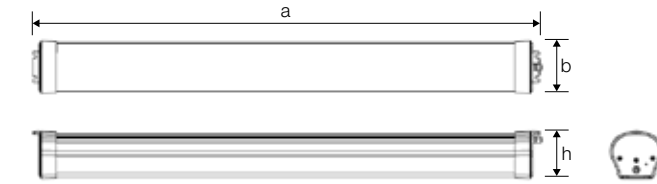

## Ürün Özellikleri

## Product Features

IP Koruma Sınıfı / IP Protection Class	: IP 66
Kullanım Şekli / Usage	: Sıva Üstü / Surface Mounted
Işık Kaynağı / Source of Light	: Floresan / Fluorescent

## Elektriksel Özellikleri

## Electrical Properties

Giriş Gerilimi / Input Voltage	: 220-240 V
Giriş Frekans / Input Frequency	: 50-60 Hz
Koruma Sınıfı / Protection Class	: Sınıf 1 / Class 1

## Diğer Özellikleri

## Other Features

Çalışma Sıcaklık Aralığı / Operating Heat Range	: -20°C / +50°C
Darbe Dayanım (IK) / Impact Resistance	: IK09
Duy / Bulb Holder	: T8

## Opsiyonel Özellikler

## Optional Features

Koruma Sınıfı / Protection Class	: Sınıf 2 / Class 2
----------------------------------	---------------------

## Gaz patlama koruması / Gas explosion protection : ZONE 1



Alüminyum enjeksiyon gövde  
Elektrostatik toz boyalı  
Temperli cam

Aluminium injection body  
Electrostatic powder coated  
Tempered glass

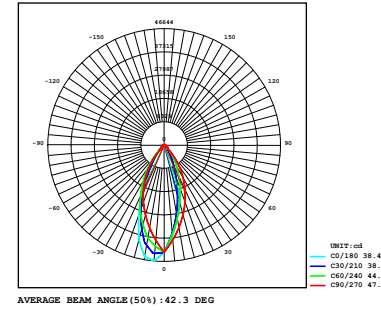

## Toz patlama koruması / Dust explosion protection : ZONE 21

## Ürün Özellikleri

## Product Features

IP Koruma Sınıfı / IP Protection Class	: IP 66
Kullanım Şekli / Usage	: Sıva Üstü / Surface Mounted
Işık Kaynağı / Source of Light	: High / Mid Power LED
Optik / Optical	: Lens

## Elektriksel Özellikleri

## Electrical Properties

Giriş Gerilimi / Input Voltage	: 220-240 V
Giriş Frekans / Input Frequency	: 50-60 Hz
Max. Gerilim Dayanımı / Max. Voltage Strength	: 10 kV
Sürüş Akımı / Driving Current	: 700 mA
Güç Faktörü / Power Factor	: > 0.95
Renksel Geriverim İndeksi / Color Rendering Index	: > 80

## Diğer Özellikleri

## Other Features

Çalışma Sıcaklık Aralığı / Operating Heat Range	: -20°C / +45°C
Darbe Dayanım (IK) / Impact Resistance	: IK10
Led Ömrü / Led Life	: 100.000 saat / hour

Renk Sıcaklığı  
Kelvin

## Opsiyonel Özellikler

## Optional Features

Renk Sıcaklığı / Kelvin	: 3000K - 4000K - 6500K
DALI	: Var / Yes
Sensör / Sensor	: Var / Yes

## FUJİ - Projektör

## FUJİ - Yüksek Tavan

## FUJİ - Kanopi

Kod Code	Güç Power	Işık Akısı Lumen	Verimlilik Efficiency	Fiyat Price (\$)
VL511100-EX	100W	14.850	148.5 lm/w	455.00
VL511150-EX	150W	20.661	137.7 lm/w	490.00
VL511200-EX	200W	25.860	129.3 lm/w	515.00
VL511250-EX	250W	30.547	122.1 lm/w	550.00

## Ölçüler

Standart	a	b	h
Standart	354	380	120

Ağırlık  
Weight (kg)

100W-150W	4,00
200W-250W	4,10

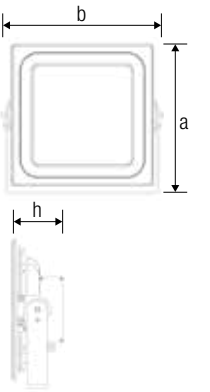

Kod Code	Güç Power	Işık Akısı Lumen	Verimlilik Efficiency	Fiyat Price (\$)
VL511100-EX-YT	100W	14.850	148.5 lm/w	455.00
VL511150-EX-YT	150W	20.661	137.7 lm/w	490.00
VL511200-EX-YT	200W	25.860	129.3 lm/w	515.00
VL511250-EX-YT	250W	30.547	122.1 lm/w	550.00

## Ölçüler

Standart	a	b	h
Standart	335	350	173

Ağırlık  
Weight (kg)

100W-150W	4,00
200W-250W	4,10

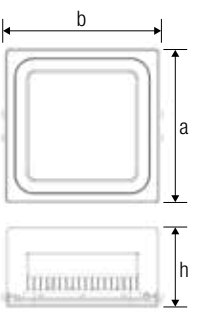

Kod Code	Güç Power	Işık Akısı Lumen	Verimlilik Efficiency	Fiyat Price (\$)
VL511060-EX-C	60W	9.580	159.6 lm/w	430.00
VL511075-EX-C	75W	11.567	154.2 lm/w	435.00
VL511090-EX-C	90W	13.365	148.5 lm/w	440.00

## Ölçüler

Standart	a	a	h	d
Standart	409	409	91	124

Ağırlık  
Weight (kg)

60W	6,30
75W	6,30
90W	6,40

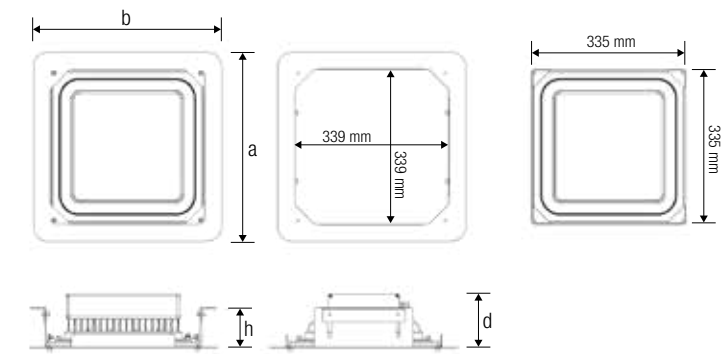

\*Çerçeve görünümü ve teknik çizimi



# KLASİK AYDINLATMA CLASSIC LIGHTING

Floresan aydınlatma sistemleri çok uzun yıllardan bugüne hayatımızın içerisinde olmaya devam ediyor. Bu bağlamda geleneksel aydınlatma sistemlerinden olan ampullerin ardından aydınlatma dünyasında bir devrim olarak nitelendirilen floresan aydınlatma ürünleri, yaklaşık 100 yıldan bugüne hayatımızda yer edinmeye devam ediyor. Floresan ürünleri günümüzde fabrika ve ofislerde birçok alanda kullanılmaya devam etmektedir.

Fluorescent lighting systems continue to be in our lives for many years. In this context, fluorescent lighting products, which are described as a revolution in the lighting world after the bulbs, which are traditional lighting systems, continue to have a place in our lives for about 100 years. Fluorescent products continue to be used in many areas in factories and offices today.





ABS gövde  
Polikarbon cam

ABS body  
Polycarbonate glass

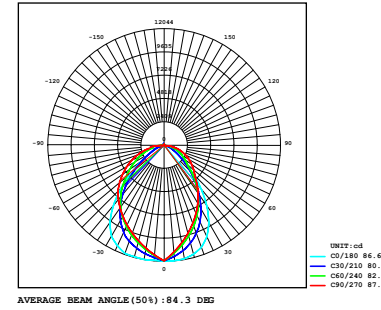

Kod Code	Güç Power	Açıklama Description	Fiyat Price (\$)
VL363114	1x14W	0,75	36.00
VL363128	1x28W	1,20	42.00
VL363154	1x54W	2,18	48.00

#### Ölçüler

Dimensions (mm)	a	b	h
1x14W	675	80	85
1x28W	1250	80	85
1x54W	1550	80	85

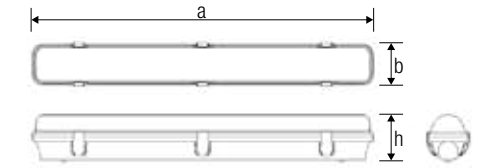

Kod Code	Güç Power	Açıklama Description	Fiyat Price (\$)
VL363214	2x14W	0,95	40.00
VL363228	2x28W	2,00	52.00
VL363254	2x54W	2,50	55.00

#### Ölçüler

Dimensions (mm)	a	b	h
2x14W	675	120	85
2x28W	1250	120	85
2x54W	1550	120	85

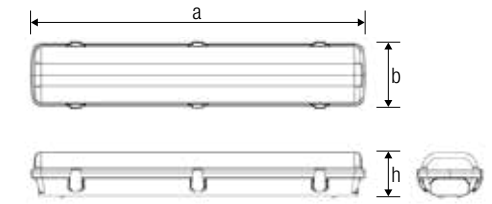

#### Ürün Özellikleri

##### Product Features

IP Koruma Sınıfı / IP Protection Class	: IP 65
Kullanım Şekli / Usage	: Sıva Üstü / Surface Mounted
Işık Kaynağı / Source of Light	: Floresan / Fluorescent

#### Elektriksel Özellikleri

##### Electrical Properties

Giriş Gerilimi / Input Voltage	: 220-240 V
Giriş Frekans / Input Frequency	: 50-60 Hz
Koruma Sınıfı / Protection Class	: Sınıf 1 / Class 1

#### Diğer Özellikleri

##### Other Features

Çalışma Sıcaklık Aralığı / Operating Heat Range	: -20°C / +45°C
Darbe Dayanım (IK) / Impact Resistance	: IK09
Duy / Bulb Holder	: T5

#### Opsiyonel Özellikler

##### Optional Features

Koruma Sınıfı / Protection Class	: Sınıf 2 / Class 2
----------------------------------	---------------------





Polimer enjeksiyon gövde  
Temperli cam

Polymer injection body  
Tempered glass

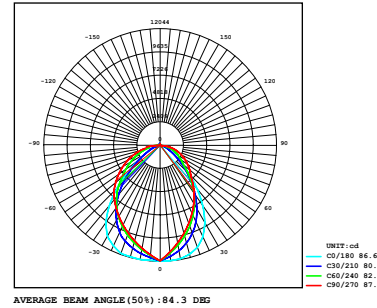

Kod Code	Güç Power	Açıklama Description	Fiyat Price (\$)
VL307050	50W	Sodyum - Metal / Soduim - Metal Halide	58.00
VL307070	70W	Sodyum - Metal / Soduim - Metal Halide	59.00
VL307110	100W	Sodyum - Metal / Soduim - Metal Halide	60.00
VL307150	150W	Sodyum - Metal / Soduim - Metal Halide	70.00

Ölçüler Dimensions (mm)	a	b	h
Standart	590	290	130

Konsol Console (mm)	Sabit / Fixed	Ø40 / Ø60

Ağırlık Weight (kg)	50W	70W	100W	150W
	3,20	3,25	3,30	4,00

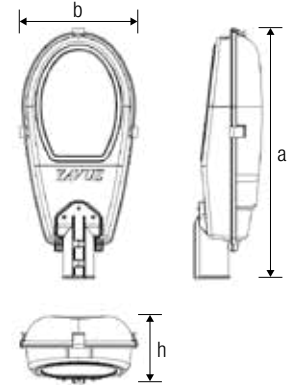

Kod Code	Güç Power	Açıklama Description	Fiyat Price (\$)
VL307250	250W	Sodyum - Metal / Soduim - Metal Halide	112.00
VL307400	400W	Sodyum - Metal / Soduim - Metal Halide	128.00

Ölçüler Dimensions (mm)	a	b	h
Standart	710	350	210

Konsol Console (mm)	Sabit / Fixed	Ø40 / Ø60

Ağırlık Weight (kg)	250W	400W
	6,80	8,70

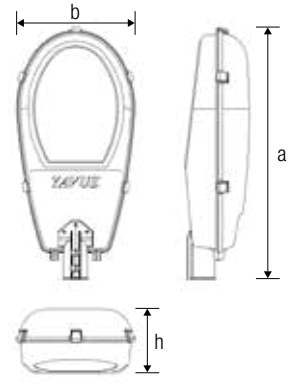

### Ürün Özellikleri

#### Product Features

IP Koruma Sınıfı / IP Protection Class	: IP 65
Kullanım Şekli / Usage	: Direk Montaj / Pole Mounted
Işık Kaynağı / Source of Light	: Ampul / Lightbulb

### Elektriksel Özellikleri

#### Electrical Properties

Giriş Gerilimi / Input Voltage	: 220-240 V
Giriş Frekans / Input Frequency	: 50-60 Hz
Balast Tipi / Ballast Type	: Alm. Sargılı / Aluminium Coil
Ateşleyici / Ignitor	: 35W-400W
Koruma Sınıfı / Protection Class	: Sınıf 1 / Class 1

### Diğer Özellikleri

#### Other Features

Çalışma Sıcaklık Aralığı / Operating Heat Range	: -20°C / +45°C
Darbe Dayanım (IK) / Impact Resistance	: IK09
Duy / Bulb Holder	: E-27 (50W-100W)
Duy / Bulb Holder	: E-40 (150W-400W)
Reflektör / Reflector	: %99 Anodized Alüminyum

### Opsiyonel Özellikler

#### Optional Features

Balast Tipi / Ballast Type	: Bakır Sargılı / Copper Coil
Kondansatör / Condenser	: 16mF-25mF-35mF-45mF
Koruma Sınıfı / Protection Class	: Sınıf 2 / Class 2



Alüminyum enjeksiyon gövde  
Temperli cam

Aluminium injection body  
Tempered glass

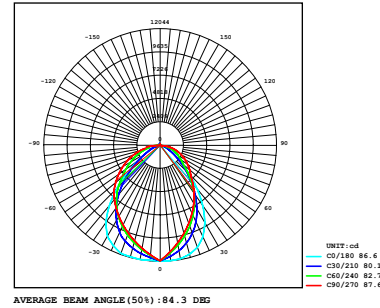

Kod Code	Güç Power	Açıklama Description	Fiyat Price (\$)
VL307050-A	50W	Sodyum - Metal / Sodium - Metal Halide	106.00
VL307070-A	70W	Sodyum - Metal / Sodium - Metal Halide	107.00
VL307110-A	100W	Sodyum - Metal / Sodium - Metal Halide	108.00
VL307150-A	150W	Sodyum - Metal / Sodium - Metal Halide	119.00

Ölçüler Dimensions (mm)	a	b	h
Standart	590	290	130

Konsol Console (mm)	Sabit / Fixed	Ø40 / Ø60

Ağırlık Weight (kg)	50W	70W	100W	150W
	4,70	4,80	5,50	5,50

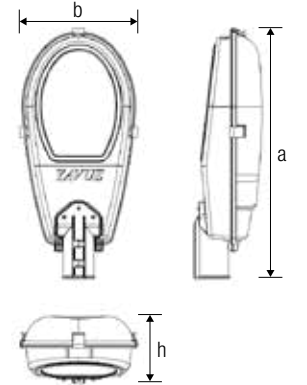

Kod Code	Güç Power	Açıklama Description	Fiyat Price (\$)
VL307250-A	250W	Sodyum - Metal / Sodium - Metal Halide	180.00
VL307400-A	400W	Sodyum - Metal / Sodium - Metal Halide	195.00

Ölçüler Dimensions (mm)	a	b	h
Standart	710	350	210

Konsol Console (mm)	Sabit / Fixed	Ø40 / Ø60

Ağırlık Weight (kg)	250W	400W
	8,60	10,00

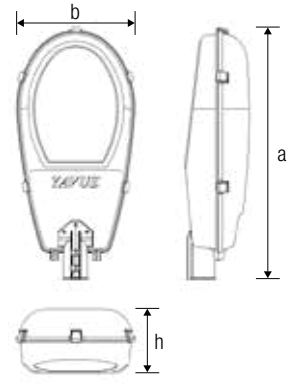

### Ürün Özellikleri

#### Product Features

IP Koruma Sınıfı / IP Protection Class	: IP 65
Kullanım Şekli / Usage	: Direk Montaj / Pole Mounted
Işık Kaynağı / Source of Light	: Ampul / Lightbulb

### Elektriksel Özellikleri

#### Electrical Properties

Giriş Gerilimi / Input Voltage	: 220-240 V
Giriş Frekans / Input Frequency	: 50-60 Hz
Balast Tipi / Ballast Type	: Alm. Sargılı / Aluminium Coil
Ateşleyici / Ignitor	: 35W-400W
Koruma Sınıfı / Protection Class	: Sınıf 1 / Class 1

### Diğer Özellikleri

#### Other Features

Çalışma Sıcaklık Aralığı / Operating Heat Range	: -20°C / +45°C
Darbe Dayanım (IK) / Impact Resistance	: IK09
Duy / Bulb Holder	: E-27 (50W-100W)
Duy / Bulb Holder	: E-40 (150W-400W)
Reflektör / Reflector	: %99 Anodized Alüminyum

### Opsiyonel Özellikler

#### Optional Features

Balast Tipi / Ballast Type	: Bakır Sargılı / Copper Coil
Kondansatör / Condenser	: 16mF-25mF-35mF-45mF
Koruma Sınıfı / Protection Class	: Sınıf 2 / Class 2



CTP cam elyaf takviyeli polyester gövde  
Temperli cam

GRP glass fiber reinforced polyester body  
Tempered glass

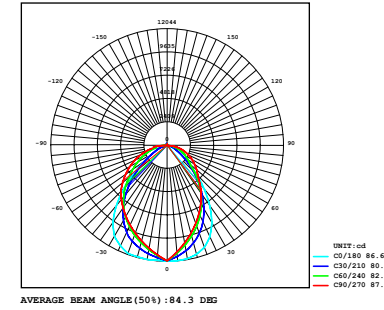

### Ürün Özellikleri

#### Product Features

IP Koruma Sınıfı / IP Protection Class	: IP 65
Kullanım Şekli / Usage	: Direk Montaj / Pole Mounted
Işık Kaynağı / Source of Light	: Ampul / Lightbulb

### Elektriksel Özellikleri

#### Electrical Properties

Giriş Gerilimi / Input Voltage	: 220-240 V
Giriş Frekans / Input Frequency	: 50-60 Hz
Balast Tipi / Ballast Type	: Alm. Sargılı / Aluminium Coil
Ateşleyici / Ignitor	: 35W-400W
Koruma Sınıfı / Protection Class	: Sınıf 1 / Class 1

### Diğer Özellikleri

#### Other Features

Çalışma Sıcaklık Aralığı / Operating Heat Range	: -20°C / +45°C
Darbe Dayanım (IK) / Impact Resistance	: IK09
Duy / Bulb Holder	: E-40 (250W-400W)
Reflektör / Reflector	: %99 Anodized Alüminyum

### Opsiyonel Özellikler

#### Optional Features

Balast Tipi / Ballast Type	: Bakır Sargılı / Copper Coil
Kondansatör / Condenser	: 16mF-25mF-35mF-45mF
Koruma Sınıfı / Protection Class	: Sınıf 2 / Class 2



Kod Code	Güç Power	Açıklama Description	Fiyat Price (\$)
VL386250	250W	Sodyum - Metal / Sodium - Metal Halide	125.00
VL386400	400W	Metal / Metal Halide	140.00
VL387400	400W	Sodyum / Sodium	140.00

### Ölçüler

#### Dimensions (mm)

Standart	a	b	h
Standart	445	420	150

### Ağırlık

#### Weight (kg)

250W	7,30
400W	8,50

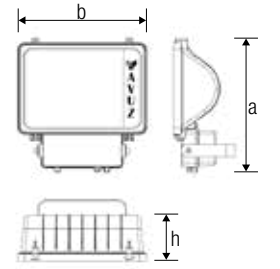

Kod Code	Güç Power	Açıklama Description	Fiyat Price (\$)
VL386100	1000W	Metal / Metal Halide	390.00

### Ölçüler

#### Dimensions (mm)

Standart	a	b	h
Standart	570	520	200

### Ağırlık

#### Weight (kg)

1000W	17,50
-------	-------

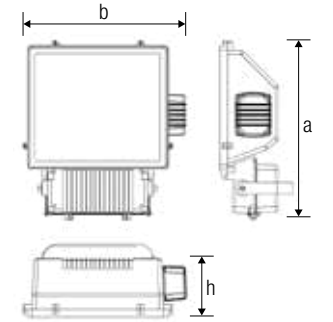

Kod Code	Güç Power	Açıklama Description	Fiyat Price (\$)
VL387200	2000W	Metal / Metal Halide	820.00

### Ölçüler

#### Dimensions (mm)

Standart	a	b	h
Standart	570	520	200

### Ağırlık

#### Weight (kg)

1000W	17,50
-------	-------

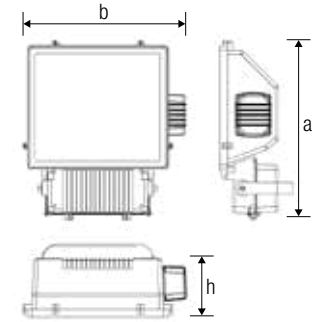

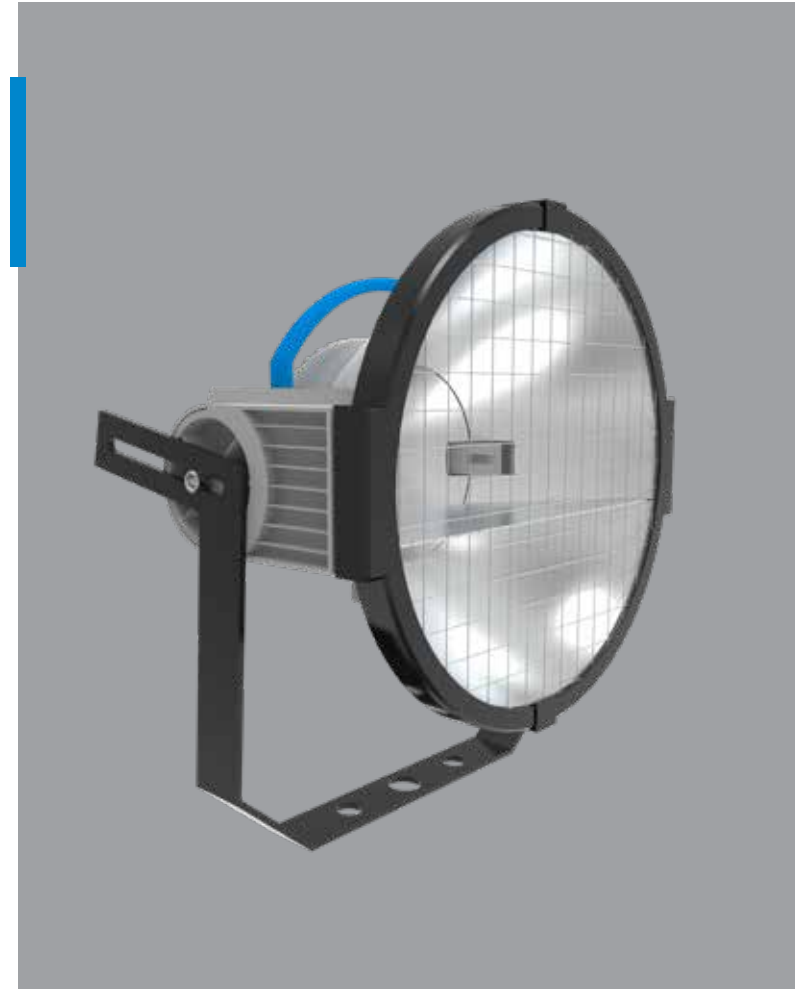

Alüminyum döküm gövde  
Temperli cam

Aluminium die-cast body  
Tempered glass

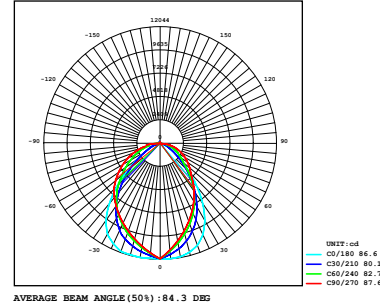

Kod Code	Güç Power	Açıklama Description	Fiyat Price (\$)
VL389100	1000W	Rotasyonel / Rotational	1.050.00
VL389200	2000W	Rotasyonel / Rotational	1.250.00

Ölçüler Dimensions (mm)	a	b	h
Standart	540	540	250

Ağırlık Weight (kg)	
1000W	17,50
2000W	16,50

### Ürün Özellikleri

#### Product Features

IP Koruma Sınıfı / IP Protection Class	: IP 65
Kullanım Şekli / Usage	: Direk Montaj / Pole Mounted
Işık Kaynağı / Source of Light	: Ampul / Lightbulb

### Elektriksel Özellikleri

#### Electrical Properties

Giriş Gerilimi / Input Voltage	: 380 V
Giriş Frekans / Input Frequency	: 50-60 Hz
Balast Tipi / Ballast Type	: Bakır Sargılı / Copper Coil
Ateşleyici / Ignitor	: 1000W-2000W
Koruma Sınıfı / Protection Class	: Sınıf 1 / Class 1

### Diğer Özellikleri

#### Other Features

Çalışma Sıcaklık Aralığı / Operating Heat Range	: -20°C / +45°C
Darbe Dayanım (IK) / Impact Resistance	: IK09
Duy / Bulb Holder	: Çift Uçlu / Double Ended
Reflektör / Reflector	: %99 Anodized Alüminyum

### Opsiyonel Özellikler

#### Optional Features

Giriş Gerilimi / Input Voltage	: 240 V
Kondansatör / Condenser	: 60mF-80mF
Duy / Bulb Holder	: E-40
Koruma Sınıfı / Protection Class	: Sınıf 2 / Class 2

# POLYESTER PANOLAR

## POLYESTER ENCLOSURES

► Polyester panolar boya ve bakım gerektirmemektedir. Rutubet, toz ve darbe gibi çevresel faktörlerden bu panolar etkilenmemektedir. Olumsuz hava şartları ve mekanik darbe ihtimali bulunan ortamlarda polyester panolar tercih edilmektedir.

Polyester panels do not require painting and maintenance. These panels are not affected by environmental factors such as humidity, dust and impact. Polyester panels are preferred in environments where adverse weather conditions and mechanical impact are likely.

# CTP CAM ELYAF TAKVİYELİ TABAN SAÇLI PANOLAR

GRP GLASS FIBER REINFORCED WITH MOUNTING PLATE PANELS



## PLYS 2030

### Taban Saçlı Pano

Enclosure With Mounting Plate

- siva üstü / surface mounted
- dökme conta ve mühür kapaklı / foam gasket and sealed door
- paslanmaz, boya ve bakım gerektirmez / rustproof, paint and maintenance free
- elektrik iletmez, yalıtıcıdır / does not conduct electricity and excellent insulation
- alev iletmez ve kendiliğinden söner / halogen free, self-extinguishing
- rutubet, nem barındırmaz / no humidity

200x300x140 mm 2,82 kg 26.00 \$



## PLYS 3040

### Taban Saçlı Pano

Enclosure With Mounting Plate

- siva üstü / surface mounted
- dökme conta ve mühür kapaklı / foam gasket and sealed door
- paslanmaz, boya ve bakım gerektirmez / rustproof, paint and maintenance free
- elektrik iletmez, yalıtıcıdır / does not conduct electricity and excellent insulation
- alev iletmez ve kendiliğinden söner / halogen free, self-extinguishing
- rutubet, nem barındırmaz / no humidity

300x400x170 mm 4,51 kg 41.00 \$



## PLYS 3550

### Taban Saçlı Pano

Enclosure With Mounting Plate

- siva üstü / surface mounted
- dökme conta ve mühür kapaklı / foam gasket and sealed door
- paslanmaz, boya ve bakım gerektirmez / rustproof, paint and maintenance free
- elektrik iletmez, yalıtıcıdır / does not conduct electricity and excellent insulation
- alev iletmez ve kendiliğinden söner / halogen free, self-extinguishing
- rutubet, nem barındırmaz / no humidity

350x500x170 mm 6,49 kg 58.00 \$



## PLYS 4060

### Taban Saçlı Pano

Enclosure With Mounting Plate

- siva üstü / surface mounted
- dökme conta ve mühür kapaklı / foam gasket and sealed door
- paslanmaz, boya ve bakım gerektirmez / rustproof, paint and maintenance free
- elektrik iletmez, yalıtıcıdır / does not conduct electricity and excellent insulation
- alev iletmez ve kendiliğinden söner / halogen free, self-extinguishing
- rutubet, nem barındırmaz / no humidity

400x600x220 mm 8,68 kg 80.00 \$



## PLYS 5070

### Taban Saçlı Pano

Enclosure With Mounting Plate

- siva üstü / surface mounted
- dökme conta ve mühür kapaklı / foam gasket and sealed door
- paslanmaz, boya ve bakım gerektirmez / rustproof, paint and maintenance free
- elektrik iletmez, yalıtıcıdır / does not conduct electricity and excellent insulation
- alev iletmez ve kendiliğinden söner / halogen free, self-extinguishing
- rutubet, nem barındırmaz / no humidity

500x700x230 mm 14,73 kg 125.00 \$



## PLYS 6080

### Taban Saçlı Pano

Enclosure With Mounting Plate

- siva üstü / surface mounted
- dökme conta ve mühür kapaklı / foam gasket and sealed door
- paslanmaz, boya ve bakım gerektirmez / rustproof, paint and maintenance free
- elektrik iletmez, yalıtıcıdır / does not conduct electricity and excellent insulation
- alev iletmez ve kendiliğinden söner / halogen free, self-extinguishing
- rutubet, nem barındırmaz / no humidity

600x800x275 mm 17,80 kg 160.00 \$



## POLYESTER TABAN SAÇLI PANOLAR WITH MOUNTING PLATE PANELS



POLYESTER PANOLAR  
POLYESTER ENCLOSURES

# CTP CAM ELYAF TAKVİYELİ TABAN SACLI PANOLAR

GRP GLASS FIBER REINFORCED WITH MOUNTING PLATE PANELS



## PLYS 7011

### Taban Sacli Pano

Enclosure With Mounting Plate

- zemin montaj / floor mount
- dökme conta / foam gasket
- paslanmaz, boya ve bakım gerektirmez / rustproof, paint and maintenance free
- elektrik iletmez, yalıtıktır / does not conduct electricity and excellent insulation
- alev iletmez ve kendiliğinden söner / halogen free, self-extinguishing
- rutubet, nem barındırmaz / no humidity

700x1100x350 mm 45,00 kg 370.00 \$



## PLYS 7011-P

### Panel Tipi Pano

Plate Type Enclosures

- zemin montaj / floor mount
- dökme conta / foam gasket
- paslanmaz, boya ve bakım gerektirmez / rustproof, paint and maintenance free
- elektrik iletmez, yalıtıktır / does not conduct electricity and excellent insulation
- alev iletmez ve kendiliğinden söner / halogen free, self-extinguishing
- rutubet, nem barındırmaz / no humidity

700x1100x350 mm 45,00 kg 350.00 \$

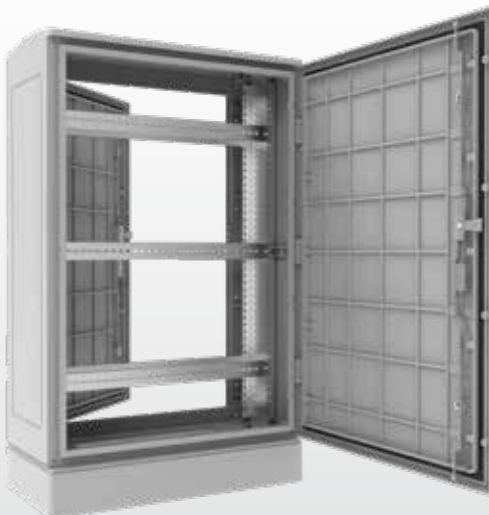

## PLYS 7011-Ç

### Çift Yönlü Panel Tipi Pano

Double Side Plate Type Enclosures

- zemin montaj / floor mount
- dökme conta / foam gasket
- paslanmaz, boya ve bakım gerektirmez / rustproof, paint and maintenance free
- elektrik iletmez, yalıtıktır / does not conduct electricity and excellent insulation
- alev iletmez ve kendiliğinden söner / halogen free, self-extinguishing
- rutubet, nem barındırmaz / no humidity

700x1100x350 mm 46,00 kg 400.00 \$



## MODÜLER SİSTEM TABAN SACLI POLYESTER PANO

Modular System Polyester Board With Mounting Plate Panel



1. Birleştirme çıtalari
2. Yan kapaklar
3. Arka kapak
4. Şapka
5. Kapı
6. Kilit ve mekanizma
7. Baza
8. Kızak
9. Montaj kulağı
10. Taban sacı



# CTP CAM ELYAF TAKVİYELİ SAYAÇ PANOLARI

GRP GLASS FIBER REINFORCED METER ENCLOSURES



**PLY 218**  
Monofaze Sayaç Panosu  
Single Phase Meter Panel



- siva üstü / surface mounted
- dökme conta ve mühür kapaklı / foam gasket and sealed door
- paslanmaz, boya ve bakım gerektirmez / rustproof, paint and maintenance free
- elektrik iletmez, yalıtıcıdır / does not conduct electricity and excellent insulation
- alev iletmez ve kendiliğinden söner / halogen free, self-extinguishing
- rutubet, nem barındırmaz / no humidity

200x300x140 mm 3,13 kg 31.00 \$



**PLY 228-1**  
Nh Kofra Panosu  
Nh Cutout Panel



- siva üstü / surface mounted
- dökme conta ve mühür kapaklı / foam gasket and sealed door
- paslanmaz, boya ve bakım gerektirmez / rustproof, paint and maintenance free
- elektrik iletmez, yalıtıcıdır / does not conduct electricity and excellent insulation
- alev iletmez ve kendiliğinden söner / halogen free, self-extinguishing
- rutubet, nem barındırmaz / no humidity

200x300x140 mm 5,18 kg 80.00 \$



**PLY 219**  
Trifaze Sayaç Panosu  
Three - Phase Meter Panel



- siva üstü / surface mounted
- dökme conta ve mühür kapaklı / foam gasket and sealed door
- paslanmaz, boya ve bakım gerektirmez / rustproof, paint and maintenance free
- elektrik iletmez, yalıtıcıdır / does not conduct electricity and excellent insulation
- alev iletmez ve kendiliğinden söner / halogen free, self-extinguishing
- rutubet, nem barındırmaz / no humidity

300x400x170 mm 5,06 kg 47.00 \$



**PLY 220**  
Trifaze Sayaç Panosu  
Three - Phase Meter Panel



- siva üstü / surface mounted
- dökme conta ve mühür kapaklı / foam gasket and sealed door
- paslanmaz, boya ve bakım gerektirmez / rustproof, paint and maintenance free
- elektrik iletmez, yalıtıcıdır / does not conduct electricity and excellent insulation
- alev iletmez ve kendiliğinden söner / halogen free, self-extinguishing
- rutubet, nem barındırmaz / no humidity

350x500x170 mm 7,28 kg 66.00 \$



**PLY 221**  
X5 Kombi Sayaç Panosu  
X5 Combi Meter Panel



- siva üstü / surface mounted
- dökme conta ve mühür kapaklı / foam gasket and sealed door
- paslanmaz, boya ve bakım gerektirmez / rustproof, paint and maintenance free
- elektrik iletmez, yalıtıcıdır / does not conduct electricity and excellent insulation
- alev iletmez ve kendiliğinden söner / halogen free, self-extinguishing
- rutubet, nem barındırmaz / no humidity

400x600x220 mm 9,58 kg 92.00 \$



**PLY 228**  
Yük Kesici + Kofra Panosu  
Load Breaker + Cutout Panel



- siva üstü / surface mounted
- dökme conta ve mühür kapaklı / foam gasket and sealed door
- paslanmaz, boya ve bakım gerektirmez / rustproof, paint and maintenance free
- elektrik iletmez, yalıtıcıdır / does not conduct electricity and excellent insulation
- alev iletmez ve kendiliğinden söner / halogen free, self-extinguishing
- rutubet, nem barındırmaz / no humidity

200x300x140 mm 5,18 kg 127.00 \$



POLYESTER PANOLAR  
POLYESTER ENCLOSURES



# PLASTİK PANOLAR

## PLASTIC ENCLOSURES

► Abs elektrik panosu, elektrik pano modeller arasında, dışarıdan gelen fizyolojik etkilere karşı en sağlam gereçlerden imal edilmiş elektrik panosudur. Abs panolar çok farklı sektörlerde ve çok farklı alanlarda kullanılabilirler.

Abs electrical panel is the electrical panel made of the most durable equipment against external physiological effects among the electrical panel models. ABS panels can be used in many different sectors and in many different areas.

# TABAN SAÇLI PLASTİK PANOLAR

## MOUNTING PLATE PLASTIC ENCLOSURES



### POLİ 022

#### Taban Saçlı Pano

##### Enclosure With Mounting Plate

- siva üstü / surface mounted
- ABS gövde, ABS kapak / ABS body, ABS cover
- poliüretan dökme conta / polyurethane foam gasket
- darbeye dayanıklı / shockproof
- çalışma sıcaklığı / operating heat -25°/ +60°



250x300x152 mm 1,57 kg 17.50 \$



### POLİ 023

#### Taban Saçlı Pano

##### Enclosure With Mounting Plate

- siva üstü / surface mounted
- ABS gövde, ABS kapak / ABS body, ABS cover
- poliüretan dökme conta / polyurethane foam gasket
- darbeye dayanıklı / shockproof
- çalışma sıcaklığı / operating heat -25°/ +60°



300x400x170 mm 2,38 kg 25.00 \$



### POLİ 024

#### Taban Saçlı Pano

##### Enclosure With Mounting Plate

- siva üstü / surface mounted
- ABS gövde, ABS kapak / ABS body, ABS cover
- poliüretan dökme conta / polyurethane foam gasket
- darbeye dayanıklı / shockproof
- çalışma sıcaklığı / operating heat -25°/ +60°



400x500x203 mm 4,60 kg 42.00 \$



### POLİ 046

#### Taban Saçlı Pano

##### Enclosure With Mounting Plate

- siva üstü / surface mounted
- ABS gövde, ABS kapak / ABS body, ABS cover
- poliüretan dökme conta / polyurethane foam gasket
- darbeye dayanıklı / shockproof
- çalışma sıcaklığı / operating heat -25°/ +60°



400x600x242 mm 5,64 kg 45.50 \$

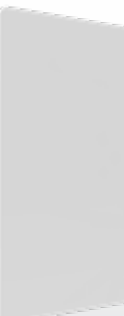

### POLİ 025

#### Taban Saçlı Pano

##### Enclosure With Mounting Plate

- siva üstü / surface mounted
- ABS gövde, ABS kapak / ABS body, ABS cover
- poliüretan dökme conta / polyurethane foam gasket
- darbeye dayanıklı / shockproof
- çalışma sıcaklığı / operating heat -25°/ +60°



500x700x225 mm 8,35 kg 79.00 \$



### POLİ 068

#### Taban Saçlı Pano

##### Enclosure With Mounting Plate

- siva üstü / surface mounted
- ABS gövde, ABS kapak / ABS body, ABS cover
- poliüretan dökme conta / polyurethane foam gasket
- darbeye dayanıklı / shockproof
- çalışma sıcaklığı / operating heat -25°/ +60°



600x800x260 mm 12,15 kg 186.00 \$

## ABS VE POLİKARBON PANOLAR

### Abs and Polycarbon Boards



# ŞEFFAF KAPAKLI TABAN SACLI PLASTİK PANOLAR

TRANSPARENT COVER MOUNTING PLATE PLASTIC ENCLOSURES



**POLİ 020**  
Taban Saclı Pano  
Enclosure With Mounting Plate



- siva üstü / surface mounted
- ABS gövde, PC kapak / ABS body, PC cover
- Contalı kapak / gasket cover
- darbeye dayanıklı / shockproof
- çalışma sıcaklığı / operating heat -25°/ +60°

235x435x115 mm 1,82 kg 18.00 \$



**POLİ 021**  
Taban Saclı Pano  
Enclosure With Mounting Plate



- siva üstü / surface mounted
- ABS gövde, PC kapak / ABS body, PC cover
- Contalı kapak / gasket cover
- darbeye dayanıklı / shockproof
- çalışma sıcaklığı / operating heat -25°/ +60°

355x560x143 mm 3,50 kg 35.00 \$



**POLİ 021**

## ŞEFFAF KAPAKLI TABAN SACLI PANOLAR Transparent Cover Enclosure With Mounting Plate



# ŞEFFAF KAPAKLI TABAN SAÇLI PLASTİK PANOLAR

TRANSPARENT COVER MOUNTING PLATE PLASTIC ENCLOSURES



**POLİ 026**  
Taban Saçlı Pano  
Enclosure With Mounting Plate

- siva üstü / surface mounted
- ABS gövde, PC kapak / ABS body, PC cover
- Contalı kapak / gasket cover
- darbeye dayanıklı / shockproof
- çalışma sıcaklığı / operating heat -25°/ +60°

250x300x152 mm 1,67 kg 20.00 \$



**POLİ 069**  
Taban Saçlı Pano  
Enclosure With Mounting Plate

- siva üstü / surface mounted
- ABS gövde, PC kapak / ABS body, PC cover
- Contalı kapak / gasket cover
- darbeye dayanıklı / shockproof
- çalışma sıcaklığı / operating heat -25°/ +60°

600x800x260 mm 12,74 kg 210.00 \$



**POLİ 027**  
Taban Saçlı Pano  
Enclosure With Mounting Plate

- siva üstü / surface mounted
- ABS gövde, PC kapak / ABS body, PC cover
- Contalı kapak / gasket cover
- darbeye dayanıklı / shockproof
- çalışma sıcaklığı / operating heat -25°/ +60°

300x400x170 mm 2,48 kg 27.00 \$



**POLİ 034**  
Taban Saçlı Pano  
Enclosure With Mounting Plate

- siva altı / recessed mounted
- ABS gövde, PC kapak / ABS body, PC cover
- Contalı kapak / gasket cover
- darbeye dayanıklı / shockproof
- çalışma sıcaklığı / operating heat -25°/ +60°

250x375x126 mm 1,52 kg 14.00 \$



**POLİ 028**  
Taban Saçlı Pano  
Enclosure With Mounting Plate

- siva üstü / surface mounted
- ABS gövde, PC kapak / ABS body, PC cover
- Contalı kapak / gasket cover
- darbeye dayanıklı / shockproof
- çalışma sıcaklığı / operating heat -25°/ +60°

400x500x203 mm 4,82 kg 49.00 \$



**POLİ 047**  
Taban Saçlı Pano  
Enclosure With Mounting Plate

- siva üstü / surface mounted
- ABS gövde, PC kapak / ABS body, PC cover
- Contalı kapak / gasket cover
- darbeye dayanıklı / shockproof
- çalışma sıcaklığı / operating heat -25°/ +60°

400x600x242 mm 5,64 kg 55.00 \$



**POLİ 029**  
Taban Saçlı Pano  
Enclosure With Mounting Plate

- siva üstü / surface mounted
- ABS gövde, PC kapak / ABS body, PC cover
- Contalı kapak / gasket cover
- darbeye dayanıklı / shockproof
- çalışma sıcaklığı / operating heat -25°/ +60°

500x700x225 mm 8,35 kg 85.00 \$



## SIVA ALTI TABAN SAÇLI PANO Recessed Mounted Enclosure With Mounting Plate



**POLİ 034**





**POLİ 007**  
Sigorta Kutusu  
MCB Boxes

12 modül kapasiteli  
12 modules capacity

- siva üstü / surface mounted
- ABS gövde, PC kapak / ABS body, PC cover
- darbeye dayanıklı / shockproof
- çalışma sıcaklığı / operating heat -25°/ +60°

290x230x115 mm 0,82 kg 10.00 \$



**POLİ 011**  
Sigorta Kutusu  
MCB Boxes

18 modül + bara giriş bölmeli  
18 modules + busbar entry section

- siva üstü / surface mounted
- ABS gövde, PC kapak / ABS body, PC cover
- contalı kapak / gasket cover
- darbeye dayanıklı / shockproof
- çalışma sıcaklığı / operating heat -25°/ +60°

235x435x115 mm 1,65 kg 20.00 \$



**POLİ 012**  
Sigorta Kutusu  
MCB Boxes

36 modül + bara giriş bölmeli  
36 modules + busbar entry section

- siva üstü / surface mounted
- ABS gövde, PC kapak / ABS body, PC cover
- contalı kapak / gasket cover
- darbeye dayanıklı / shockproof
- çalışma sıcaklığı / operating heat -25°/ +60°

355x560x143 mm 3,40 kg 36.00 \$



**POLİ 012-1**  
Sigorta Kutusu  
MCB Boxes

45 modül + bara giriş bölmeli  
45 modules + busbar entry section

- siva üstü / surface mounted
- ABS gövde, PC kapak / ABS body, PC cover
- contalı kapak / gasket cover
- darbeye dayanıklı / shockproof
- çalışma sıcaklığı / operating heat -25°/ +60°

355x560x143 mm 3,40 kg 36.00 \$



POLİ 012-1

POLİ 012

POLİ 011

POLİ 007



POLİ 007

Siva Üstü 12 Modüllü Sigorta Kutusu



POLİ 011

Siva Üstü 18 Modüllü Sigorta Kutusu



POLİ 012

Siva Üstü 36 Modüllü Sigorta Kutusu



POLİ 012-1

Siva Üstü 45 Modüllü Sigorta Kutusu

# SIVA ALTI MODÜLER SİGORTA KUTULARI

RECESSED MODULAR MCB BOXES



## POLİ 006 Sigorta Kutusu MCB Boxes

5 modül kapasiteli  
5 modules capacity

- siva altı / recessed mounted
- ABS gövde, PC kapak / ABS body, PC cover
- darbeye dayanıklı / shockproof
- çalışma sıcaklığı / operating heat -25°/ +60°

158x153x97 mm 0,32 kg 4.70 \$



## POLİ 013 Sigorta Kutusu MCB Boxes

12 modül kapasiteli  
12 modules capacity

- siva altı / recessed mounted
- ABS gövde, PC kapak / ABS body, PC cover
- darbeye dayanıklı / shockproof
- çalışma sıcaklığı / operating heat -25°/ +60°

290x211x100 mm 0,73 kg 8.80 \$



## POLİ 014 Sigorta Kutusu MCB Boxes

24 modül kapasiteli  
24 modules capacity

- siva altı / recessed mounted
- ABS gövde, PC kapak / ABS body, PC cover
- darbeye dayanıklı / shockproof
- çalışma sıcaklığı / operating heat -25°/ +60°

290x383x100 mm 1,31 kg 18.50 \$



## POLİ 014-1 Sigorta Kutusu MCB Boxes

36 modül kapasiteli  
36 modules capacity

- siva altı / recessed mounted
- ABS gövde, PC kapak / ABS body, PC cover
- darbeye dayanıklı / shockproof
- çalışma sıcaklığı / operating heat -25°/ +60°

290x563x100 mm 2,12 kg 29.00 \$



POLİ 014-1



POLİ 014



POLİ 013



POLİ 006



Siva Altı 5 Modüllü Sigorta Kutusu



Siva Altı 12 Modüllü Sigorta Kutusu



Siva Altı 24 Modüllü Sigorta Kutusu



Siva Altı 36 Modüllü Sigorta Kutusu

# SIVA ALTI SİĞORTA KUTULARI

RECESSED MCB BOXES

**YENİ**

**POLİ 015**  
Sigorta Kutusu  
MCB Boxes

24 modül kapasiteli  
24 modules capacity

- sıva altı / recessed mounted
- ABS gövde ve çerçeve, PC kapak / ABS body and frame, PC cover
- darbeye dayanıklı / shockproof
- çalışma sıcaklığı / operating heat -25°/ +60°

330x370x107 mm 1,18 kg YAKINDA

POLİ 015-K Toprak Klemensi Dahil YAKINDA

\* 10'lu prinç klemens

**YENİ**

**POLİ 018**  
Sigorta Kutusu  
MCB Boxes

36 modül kapasiteli  
36 modules capacity

- sıva altı / recessed mounted
- ABS gövde ve çerçeve, PC kapak / ABS body and frame, PC cover
- darbeye dayanıklı / shockproof
- çalışma sıcaklığı / operating heat -25°/ +60°

330x495x107 mm 2,09 kg 23.00 \$

POLİ 018-K Toprak Klemensi Dahil 26.50 \$

\* 2x10 prinç klemens

**YENİ**

**POLİ 019**  
Sigorta Kutusu  
MCB Boxes

45 modül kapasiteli  
45 modules capacity

- sıva altı / recessed mounted
- ABS gövde ve çerçeve, PC kapak / ABS body and frame, PC cover
- darbeye dayanıklı / shockproof
- çalışma sıcaklığı / operating heat -25°/ +60°

390x535x107 mm 2,52 kg 27.00 \$

POLİ 019-K Toprak Klemensi Dahil 30.50 \$

\* 2x10 prinç klemens

**YENİ**

**POLİ 015** **POLİ 018** **POLİ 019**

**YENİ SIVA ALTI SİĞORTA KUTULARI**  
**NEW RECESSED MCB BOXES**

IP 40 IK 08

**POLİ 015**

• ABS gövde  
• ABS çerçeve  
• PC kapak

Sıva Altı 24 Modüllü Sigorta Kutusu

1. Gövde 2. Çerçeve 3. Kapak 4. Montaj Çıtası 5. Sigorta Rayı 6. Klemens Çıtası

**POLİ 018**

• ABS gövde  
• ABS çerçeve  
• PC kapak

Sıva Altı 36 Modüllü Sigorta Kutusu

1. Gövde 2. Çerçeve 3. Kapak 4. Montaj Çıtası 5. Sigorta Rayı 6. Klemens Çıtası

**POLİ 019**

• ABS gövde  
• ABS çerçeve  
• PC kapak

Sıva Altı 45 Modüllü Sigorta Kutusu

1. Gövde 2. Çerçeve 3. Kapak 4. Montaj Çıtası 5. Sigorta Rayı 6. Klemens Çıtası

# SIVA ALTI SAC GÖVDE SİGORTA KUTULARI

RECESSED METAL BODY MCB BOXES

**YENİ**

**POLİ 015-1**  
Sigorta Kutusu  
MCB Boxes

24 modül kapasiteli  
24 modules capacity

- sıva altı / recessed mounted
- sac gövde, ABS çerçeve, PC kapak / metal body, ABS frame, PC cover
- darbeye dayanıklı / shockproof
- çalışma sıcaklığı / operating heat -25°/ +60°

330x370x107 mm 1,18 kg YAKINDA

POLİ 015-1-K Toprak Klemensi Dahil YAKINDA

\* 10'lu prinç klemens

**YENİ**

**POLİ 018-1**  
Sigorta Kutusu  
MCB Boxes

36 modül kapasiteli  
36 modules capacity

- sıva altı / recessed mounted
- sac gövde, ABS çerçeve, PC kapak / metal body, ABS frame, PC cover
- darbeye dayanıklı / shockproof
- çalışma sıcaklığı / operating heat -25°/ +60°

330x495x107 mm 2,09 kg 50.00 \$

POLİ 018-1-K Toprak Klemensi Dahil 53.50 \$

\* 2x10 prinç klemens

**YENİ**

**POLİ 019-1**  
Sigorta Kutusu  
MCB Boxes

45 modül kapasiteli  
45 modules capacity

- sıva altı / recessed mounted
- sac gövde, ABS çerçeve, PC kapak / metal body, ABS frame, PC cover
- darbeye dayanıklı / shockproof
- çalışma sıcaklığı / operating heat -25°/ +60°

390x535x107 mm 2,52 kg 75.00 \$

POLİ 019-1-K Toprak Klemensi Dahil 78.50 \$

\* 2x10 prinç klemens

**YENİ**

**YENİ SIVA ALTI SİGORTA KUTULARI**  
NEW RECESSED MCB BOXES

POLİ 015-1 POLİ 018-1 POLİ 019-1

IP 40 IK 08

**Sıva Altı 24 Modüllü Sigorta Kutusu**

1. Sac gövde  
2. ABS çerçeve  
3. PC kapak

4. Montaj Çıtası  
5. Sigorta Rayı  
6. Klemens Çıtası

POLİ 015-1

**Sıva Altı 36 Modüllü Sigorta Kutusu**

1. Sac gövde  
2. ABS çerçeve  
3. PC kapak

4. Montaj Çıtası  
5. Sigorta Rayı  
6. Klemens Çıtası

POLİ 018-1

**Sıva Altı 45 Modüllü Sigorta Kutusu**

1. Sac gövde  
2. ABS çerçeve  
3. PC kapak

4. Montaj Çıtası  
5. Sigorta Rayı  
6. Klemens Çıtası

POLİ 019-1



**YPTK 036-P10**

Sigorta Kutusu

MCB Boxes

**36 modül + zayıf akım (15 cm)**  
**36 modules + control circuit place**

- siva altı / recessed mounted
- sac gövde, PC kapak / metal body, PC cover
- darbeye dayanıklı / shockproof
- çalışma sıcaklığı / operating heat -25°/ +60°

400x566x100 mm 4,80 kg 84.00 \$

**YPTK 036-P11**

Sigorta Kutusu

MCB Boxes

**54 modül kapasiteli**  
**54 modules capacity**

- siva altı / recessed mounted
- sac gövde, PC kapak / metal body, PC cover
- darbeye dayanıklı / shockproof
- çalışma sıcaklığı / operating heat -25°/ +60°

400x566x100 mm 4,80 kg 83.00 \$

**YPTK 048-P20**

Sigorta Kutusu

MCB Boxes

**36 modül + zayıf akım (30 cm)**  
**36 modules + control circuit place**

- siva altı / recessed mounted
- sac gövde, PC kapak / metal body, PC cover
- darbeye dayanıklı / shockproof
- çalışma sıcaklığı / operating heat -25°/ +60°

400x894x100 mm 8,00 kg 131.00 \$

**YPTK 048-P21**

Sigorta Kutusu

MCB Boxes

**72 modül kapasiteli**  
**72 modules capacity**

- siva altı / recessed mounted
- sac gövde, PC kapak / metal body, PC cover
- darbeye dayanıklı / shockproof
- çalışma sıcaklığı / operating heat -25°/ +60°

400x894x100 mm 8,00 kg 129.00 \$



# SIVA ALTI VE SIVA ÜSTÜ SAYAÇ VE DAĞITIM PANOLARI

RECESSED AND SURFACE MOUNTED METER AND DISTRIBUTION ENCLOSURES



## POLİ 101

Sayaç Dağıtım Panosu  
Meter Distribution Enclosure

9 modül + monofaze sayaç / trifaze sayaç  
9 modules + monophase meter / triphase meter

- siva altı / recessed mounted
- ABS gövde, PC kapak / ABS body, PC cover
- darbeye dayanıklı / shockproof
- çalışma sıcaklığı / operating heat -25°/ +60°

250x375x126 mm 1,26 kg 14.00 \$



## POLİ 101-1

Sayaç Dağıtım Panosu  
Meter Distribution Enclosure

9 modül + monofaze sayaç / trifaze sayaç  
9 modules + monophase meter / triphase meter

- siva altı / recessed mounted
- sac gövde, PC kapak / metal body, PC cover
- darbeye dayanıklı / shockproof
- çalışma sıcaklığı / operating heat -25°/ +60°

250x375x126 mm 1,60 kg 40.00 \$



## POLİ 016

Sayaç Dağıtım Panosu  
Meter Distribution Enclosure

9 modül + monofaze sayaç / trifaze sayaç  
9 modules + monophase meter / triphase meter

- siva üstü / surface mounted
- ABS gövde, PC kapak / ABS body, PC cover
- contalı kapak / gasket cover
- darbeye dayanıklı / shockproof
- çalışma sıcaklığı / operating heat -25°/ +60°

235x435x115 mm 1,63 kg 19.50 \$



## POLİ 017

Sayaç Dağıtım Panosu  
Meter Distribution Enclosure

15 modül + monofaze sayaç / trifaze sayaç  
15 modules + monophase meter / triphase meter

- siva üstü / surface mounted
- ABS gövde, PC kapak / ABS body, PC cover
- contalı kapak / gasket cover
- darbeye dayanıklı / shockproof
- çalışma sıcaklığı / operating heat -25°/ +60°

355x560x143 mm 3,40 kg 34.00 \$



## SIVA ALTI SAYAÇ DAĞITIM PANOSU RECESSED DISTRIBUTION ENCLOSURES



POLİ 101



POLİ 016

Siva Üstü

9 Modüllü Monafaze / trifaze sayaç kutusu



POLİ 017

Siva Üstü

9 Modüllü Monafaze / trifaze sayaç kutusu

PLASTİK PANOLAR  
PLASTIC ENCLOSURES



### POLİ 016-E

Sayaç Dağıtım Panosu  
Meter Distribution Enclosure

9 modül + monofaze sayaç / trifaze sayaç  
9 modules + monophase meter / triphase meter

- siva üstü / surface mounted
- ABS gövde, ABS kapak / ABS body, ABS cover
- poliüretan dökme conta / polyurethane foam gasket
- darbeye dayanıklı / shockproof
- çalışma sıcaklığı / operating heat -25°/ +60°

233x420x115 mm 1,18 kg 14.00 \$



### POLİ 017-E

Sayaç Dağıtım Panosu  
Meter Distribution Enclosure

12 modül + monofaze sayaç / trifaze sayaç  
12 modules + monophase meter / triphase meter

- siva üstü / surface mounted
- ABS gövde, ABS kapak / ABS body, ABS cover
- poliüretan dökme conta / polyurethane foam gasket
- darbeye dayanıklı / shockproof
- çalışma sıcaklığı / operating heat -25°/ +60°

342x578x136 mm 2,30 kg 28.00 \$



### POLİ 038

Sayaç Dağıtım Panosu  
Meter Distribution Enclosure

6 modül + monofaze sayaç  
6 modules + monophase meter

- siva üstü / surface mounted
- ABS gövde, ABS kapak / ABS body, ABS cover
- poliüretan dökme conta / polyurethane foam gasket
- darbeye dayanıklı / shockproof
- çalışma sıcaklığı / operating heat -25°/ +60°

250x300x152 mm 1,78 kg 20.00 \$



### POLİ 038-1

Sayaç Dağıtım Panosu  
Meter Distribution Enclosure

15 modül + monofaze sayaç  
15 modules + monophase meter

- siva üstü / surface mounted
- ABS gövde, ABS kapak / ABS body, ABS cover
- poliüretan dökme conta / polyurethane foam gasket
- darbeye dayanıklı / shockproof
- çalışma sıcaklığı / operating heat -25°/ +60°

300x400x170 mm 3,18 kg 30.00 \$



### POLİ 033

Sayaç Dağıtım Panosu  
Meter Distribution Enclosure

14 modül + 2 monofaze sayaç  
14 modules + 2 monophase meter

- siva üstü / surface mounted
- ABS gövde, ABS kapak / ABS body, ABS cover
- poliüretan dökme conta / polyurethane foam gasket
- darbeye dayanıklı / shockproof
- çalışma sıcaklığı / operating heat -25°/ +60°

400x500x203 mm 6,40 kg 52.00 \$



### POLİ 039

Sayaç Dağıtım Panosu  
Meter Distribution Enclosure

12 modül + trifaze ve monofaze priz + trifaze sayaç  
12 modules + triphase and monophase socket + triphase meter

- siva üstü / surface mounted
- ABS gövde, ABS kapak / ABS body, ABS cover
- poliüretan dökme conta / polyurethane foam gasket
- darbeye dayanıklı / shockproof
- çalışma sıcaklığı / operating heat -25°/ +60°

400x500x203 mm 6,13 kg 48.00 \$



### POLİ 040

Sayaç Dağıtım Panosu  
Meter Distribution Enclosure

23 modül + trifaze sayaç  
23 modules + triphase meter

- siva üstü / surface mounted
- ABS gövde, ABS kapak / ABS body, ABS cover
- poliüretan dökme conta / polyurethane foam gasket
- darbeye dayanıklı / shockproof
- çalışma sıcaklığı / operating heat -25°/ +60°

400x550x203 mm 5,39 kg 48.00 \$



POLİ 016-E

Sıva Üstü

9 Modüllü Monafaze / trifaze sayaç kutusu



POLİ 017-E

Sıva Üstü

12 Modüllü Monafaze / trifaze sayaç kutusu



**POLİ 041**  
Sayaç Dağıtım Panosu  
Meter Distribution Enclosure

18 modül + 25A-160A kompakt şalter + 2 trifaze sayaç  
18 modules + 25A-160A MCCB + 2 triphase meter

- siva üstü / surface mounted
- ABS gövde, ABS kapak / ABS body, ABS cover
- poliüretan dökme conta / polyurethane foam gasket
- darbeye dayanıklı / shockproof
- çalışma sıcaklığı / operating heat -25°/ +60°

500x700x225 mm 9,31 kg 82.00 \$



**POLİ 051**  
Dağıtım Panosu  
Distribution Enclosure

40 modül + 4 priz + klemens bölümü  
40 modules + 4 socket + terminal area

- siva üstü / surface mounted
- ABS gövde, ABS kapak / ABS body, ABS cover
- poliüretan dökme conta / polyurethane foam gasket
- darbeye dayanıklı / shockproof
- çalışma sıcaklığı / operating heat -25°/ +60°

500x700x225 mm 8,78 kg 82.00 \$



**POLİ 042**  
Sayaç Dağıtım Panosu  
Meter Distribution Enclosure

36 modül + 4 priz + monofaze sayaç  
36 modules + 4 socket + monophas meter

- siva üstü / surface mounted
- ABS gövde, ABS kapak / ABS body, ABS cover
- poliüretan dökme conta / polyurethane foam gasket
- darbeye dayanıklı / shockproof
- çalışma sıcaklığı / operating heat -25°/ +60°

500x700x225 mm 8,96 kg 82.00 \$



**POLİ 052**  
Dağıtım Panosu  
Distribution Enclosure

40 modül + 25A-160A kompakt şalter + klemens bölümü  
40 modules + 25A-160A MCCB + terminal area

- siva üstü / surface mounted
- ABS gövde, ABS kapak / ABS body, ABS cover
- poliüretan dökme conta / polyurethane foam gasket
- darbeye dayanıklı / shockproof
- çalışma sıcaklığı / operating heat -25°/ +60°

500x700x225 mm 9,25 kg 82.00 \$



**POLİ 043**  
Sayaç Dağıtım Panosu  
Meter Distribution Enclosure

36 modül + 25A-160A kompakt şalter + trifaze sayaç  
36 modules + 25A-160A MCCB + triphase meter

- siva üstü / surface mounted
- ABS gövde, ABS kapak / ABS body, ABS cover
- poliüretan dökme conta / polyurethane foam gasket
- darbeye dayanıklı / shockproof
- çalışma sıcaklığı / operating heat -25°/ +60°

500x700x225 mm 9,29 kg 82.00 \$



**POLİ 053**  
Dağıtım Panosu  
Distribution Enclosure

60 modül + 25A-160A kompakt şalter  
60 modules + 25A-160A MCCB

- siva üstü / surface mounted
- ABS gövde, ABS kapak / ABS body, ABS cover
- poliüretan dökme conta / polyurethane foam gasket
- darbeye dayanıklı / shockproof
- çalışma sıcaklığı / operating heat -25°/ +60°

500x700x225 mm 8,57 kg 82.00 \$



**POLİ 043-Ç**  
Sayaç Dağıtım Panosu  
Meter Distribution Enclosure

18 modül + 2 trifaze sayaç + klemens bölümü  
18 modules + 2 triphase meter + terminal area

- siva üstü / surface mounted
- ABS gövde, ABS kapak / ABS body, ABS cover
- poliüretan dökme conta / polyurethane foam gasket
- darbeye dayanıklı / shockproof
- çalışma sıcaklığı / operating heat -25°/ +60°

500x700x225 mm 9,08 kg 82.00 \$



**POLİ 054**  
Dağıtım Panosu  
Distribution Enclosure

60 modül + klemens bölümü  
60 modules + terminal area

- siva üstü / surface mounted
- ABS gövde, ABS kapak / ABS body, ABS cover
- poliüretan dökme conta / polyurethane foam gasket
- darbeye dayanıklı / shockproof
- çalışma sıcaklığı / operating heat -25°/ +60°

500x700x225 mm 8,57 kg 82.00 \$



**POLİ 045**  
Sayaç Dağıtım Panosu  
Meter Distribution Enclosure

X/5 sayaç + akım trafosu + K.A.K.R + kompakt şalter  
X/5 meter + current transformer + RCD + MCCB

- siva üstü / surface mounted
- ABS gövde, ABS kapak / ABS body, ABS cover
- poliüretan dökme conta / polyurethane foam gasket
- darbeye dayanıklı / shockproof
- çalışma sıcaklığı / operating heat -25°/ +60°

500x700x225 mm 12,53 kg 94.00 \$



**POLİ 055**  
Dağıtım Panosu  
Distribution Enclosure

30 modül + 2 priz  
30 modules + 2 socket

- siva üstü / surface mounted
- ABS gövde, ABS kapak / ABS body, ABS cover
- poliüretan dökme conta / polyurethane foam gasket
- darbeye dayanıklı / shockproof
- çalışma sıcaklığı / operating heat -25°/ +60°

400x500x203 mm 4,71 kg 48.00 \$



### POLİ 056

#### Dağıtım Panosu

##### Distribution Enclosure

15 modül + 25A-160A kompakt şalter + klemens bölümü  
15 modules + 25A-160A MCCB + terminal area

- siva üstü / recessed mounted
- ABS gövde, ABS kapak / ABS body, ABS cover
- poliüretan dökme conta / polyurethane foam gasket
- darbeye dayanıklı / shockproof
- çalışma sıcaklığı / operating heat -25°/ +60°

400x500x203 mm 5,18 kg 48.00 \$



### POLİ 063

#### Dağıtım Panosu

##### Distribution Enclosure

20 modül kapasiteli  
20 modules capacity

- siva üstü / surface mounted
- ABS gövde, ABS kapak / ABS body, ABS cover
- poliüretan dökme conta / polyurethane foam gasket
- darbeye dayanıklı / shockproof
- çalışma sıcaklığı / operating heat -25°/ +60°

250x300x152 mm 1,92 kg 20.00 \$



### POLİ 057

#### Dağıtım Panosu

##### Distribution Enclosure

45 modül kapasiteli  
45 modules capacity

- siva üstü / surface mounted
- ABS gövde, ABS kapak / ABS body, ABS cover
- poliüretan dökme conta / polyurethane foam gasket
- darbeye dayanıklı / shockproof
- çalışma sıcaklığı / operating heat -25°/ +60°

400x500x203 mm 4,74 kg 48.00 \$



### POLİ 064

#### Dağıtım Panosu

##### Distribution Enclosure

10 modül + klemens bölümü  
10 modules + terminal area

- siva üstü / surface mounted
- ABS gövde, ABS kapak / ABS body, ABS cover
- poliüretan dökme conta / polyurethane foam gasket
- darbeye dayanıklı / shockproof
- çalışma sıcaklığı / operating heat -25°/ +60°

250x300x152 mm 1,84 kg 20.00 \$



### POLİ 058

#### Dağıtım Panosu

##### Distribution Enclosure

30 modül + klemens bölümü  
30 modules + terminal area

- siva üstü / surface mounted
- ABS gövde, ABS kapak / ABS body, ABS cover
- poliüretan dökme conta / polyurethane foam gasket
- darbeye dayanıklı / shockproof
- çalışma sıcaklığı / operating heat -25°/ +60°

400x500x203 mm 4,76 kg 48.00 \$



### POLİ 061

#### Dağıtım Panosu

##### Distribution Enclosure

30 modül kapasiteli  
30 modules capacity

- siva üstü / surface mounted
- ABS gövde, ABS kapak / ABS body, ABS cover
- poliüretan dökme conta / polyurethane foam gasket
- darbeye dayanıklı / shockproof
- çalışma sıcaklığı / operating heat -25°/ +60°

300x400x170 mm 2,83 kg 28.00 \$



### POLİ 062

#### Dağıtım Panosu

##### Distribution Enclosure

20 modül + klemens bölümü  
20 modules + terminal area

- siva üstü / surface mounted
- ABS gövde, ABS kapak / ABS body, ABS cover
- poliüretan dökme conta / polyurethane foam gasket
- darbeye dayanıklı / shockproof
- çalışma sıcaklığı / operating heat -25°/ +60°

300x400x170 mm 2,83 kg 28.00 \$





**POLİ 037-Ş**

Duvar Tipi Şantiye Panosu  
Wall Mounted Worksite Enclosure

27 modül + 4 priz + trifaze sayaç  
27 modules + socket + triphase meter

- siva üstü / surface mounted
- ABS gövde, ABS kapak, ABS şapka / ABS body, ABS cover, ABS canopy
- poliüretan dökme conta / polyurethane foam gasket
- darbeye dayanıklı / shockproof
- çalışma sıcaklığı / operating heat -25°/ +60°

500x700x225 mm 9,50 kg 89.00 \$



**POLİ 024-Ş4**

Ayaklı Tip Şantiye Panosu  
Standing Type Worksite Enclosure

30 modül + 6 priz + klemens bölümü  
30 modules + 6 socket + terminal area

- ABS gövde, ABS kapak, ABS şapka / ABS body, ABS cover, ABS canopy
- metal ayak / metal base 302 mm
- poliüretan dökme conta / polyurethane foam gasket
- darbeye dayanıklı / shockproof
- çalışma sıcaklığı / operating heat -25°/ +60°

400x500x203 mm 9,05 kg 82.00 \$



**POLİ 039-Ş**

Duvar Tipi Şantiye Panosu  
Wall Mounted Worksite Enclosure

12 modül + trifaze ve monofaze priz + trifaze sayaç  
12 modules + triphase and monophase socket + triphase meter

- siva üstü / surface mounted
- ABS gövde, ABS kapak, ABS şapka / ABS body, ABS cover, ABS canopy
- poliüretan dökme conta / polyurethane foam gasket
- darbeye dayanıklı / shockproof
- çalışma sıcaklığı / operating heat -25°/ +60°

400x500x203 mm 6,60 kg 53.00 \$



**POLİ 035**

Ayaklı Tip Şantiye Panosu  
Standing Type Worksite Enclosure

27 modül + 8 priz + trifaze sayaç  
27 modules + socket + triphase meter

- ABS gövde, ABS kapak, ABS şapka / ABS body, ABS cover, ABS canopy
- metal ayak / metal base 302 mm
- poliüretan dökme conta / polyurethane foam gasket
- darbeye dayanıklı / shockproof
- çalışma sıcaklığı / operating heat -25°/ +60°

500x700x225 mm 14,20 kg 123.00 \$



**POLİ 040-Ş**

Duvar Tipi Şantiye Panosu  
Wall Mounted Worksite Enclosure

23 modül + trifaze sayaç  
23 modules + triphase meter

- siva üstü / surface mounted
- ABS gövde, ABS kapak, ABS şapka / ABS body, ABS cover, ABS canopy
- poliüretan dökme conta / polyurethane foam gasket
- darbeye dayanıklı / shockproof
- çalışma sıcaklığı / operating heat -25°/ +60°

400x500x203 mm 5,86 kg 53.00 \$



**POLİ 036**

Ayaklı Tip Şantiye Panosu  
Standing Type Worksite Enclosure

60 modül + 8 priz + klemens bölümü  
60 modules + 8 socket + terminal area

- ABS gövde, ABS kapak, ABS şapka / ABS body, ABS cover, ABS canopy
- metal ayak / metal base 302 mm
- poliüretan dökme conta / polyurethane foam gasket
- darbeye dayanıklı / shockproof
- çalışma sıcaklığı / operating heat -25°/ +60°

500x700x225 mm 13,39 kg 123.00 \$



**POLİ 024-Ş1**

Ayaklı Tip Şantiye Panosu  
Standing Type Worksite Enclosure

23 modül + 6 priz + trifaze sayaç  
23 modules + 6 socket + triphase meter

- ABS gövde, ABS kapak, ABS şapka / ABS body, ABS cover, ABS canopy
- metal ayak / metal base 302 mm
- poliüretan dökme conta / polyurethane foam gasket
- darbeye dayanıklı / shockproof
- çalışma sıcaklığı / operating heat -25°/ +60°

400x500x203 mm 9,68 kg 82.00 \$



**POLİ 037**

Ayaklı Tip Şantiye Panosu  
Standing Type Worksite Enclosure

27 modül + 4 priz + trifaze sayaç  
27 modules + 4 socket + triphase meter

- ABS gövde, ABS kapak, ABS şapka / ABS body, ABS cover, ABS canopy
- metal ayak / metal base 302 mm
- poliüretan dökme conta / polyurethane foam gasket
- darbeye dayanıklı / shockproof
- çalışma sıcaklığı / operating heat -25°/ +60°

500x700x225 mm 12,11 kg 115.00 \$



**POLİ 024-Ş3**

Ayaklı Tip Şantiye Panosu  
Standing Type Worksite Enclosure

12 modül + trifaze ve monofaze priz + trifaze sayaç  
12 modules + triphase and monophase socket + triphase meter

- ABS gövde, ABS kapak, ABS şapka / ABS body, ABS cover, ABS canopy
- metal ayak / metal base 302 mm
- poliüretan dökme conta / polyurethane foam gasket
- darbeye dayanıklı / shockproof
- çalışma sıcaklığı / operating heat -25°/ +60°

400x500x203 mm 9,05 kg 76.00 \$



# TABAN SAÇLI ŞANTIYE PANOLARI

## MOUNTING PLATE WORKSITE ENCLOSURES



### POLİ 01ŞDT

Duvar Tipi Şantiye Panosu  
Wall Mounted Worksite Enclosure



#### Taban Saçlı Mounting Plate

- sıva üstü / surface mounted
- ABS gövde, ABS kapak, ABS şapka / ABS body, ABS cover, ABS canopy
- poliüretan dökme conta / polyurethane foam gasket
- darbeye dayanıklı / shockproof
- çalışma sıcaklığı / operating heat -25°/ +60°

400x500x203 mm 5,07 kg 47.00 \$



### POLİ 01DT

Duvar Tipi Şantiye Panosu  
Wall Mounted Worksite Enclosure



#### Taban Saçlı Mounting Plate

- sıva üstü / surface mounted
- ABS gövde, ABS kapak, ABS şapka / ABS body, ABS cover, ABS canopy
- poliüretan dökme conta / polyurethane foam gasket
- darbeye dayanıklı / shockproof
- çalışma sıcaklığı / operating heat -25°/ +60°

500x700x225 mm 9,02 kg 86.00 \$



### POLİ 00ŞT

Ayaklı Tip Şantiye Panosu  
Standing Type Worksite Enclosure



#### Taban Saçlı Mounting Plate

- ABS gövde, ABS kapak, ABS şapka / ABS body, ABS cover, ABS canopy
- metal ayak / metal base 302 mm
- poliüretan dökme conta / polyurethane foam gasket
- darbeye dayanıklı / shockproof
- çalışma sıcaklığı / operating heat -25°/ +60°

400x500x203 mm 7,52 kg 70.00 \$



### POLİ 01ŞT

Ayaklı Tip Şantiye Panosu  
Standing Type Worksite Enclosure



#### Taban Saçlı Mounting Plate

- ABS gövde, ABS kapak, ABS şapka / ABS body, ABS cover, ABS canopy
- metal ayak / metal base 302 mm
- poliüretan dökme conta / polyurethane foam gasket
- darbeye dayanıklı / shockproof
- çalışma sıcaklığı / operating heat -25°/ +60°

500x700x225 mm 11,61 kg 112.00 \$



### POLİ 096

Pano Şapkası  
Canopy Cover



- harici ortam / outdoor
- ABS şapka / ABS canopy
- darbeye dayanıklı / shockproof

400x55x210 mm 0,46 kg 5.00 \$



### POLİ 097

Pano Şapkası  
Canopy Cover



- harici ortam / outdoor
- ABS şapka / ABS canopy
- darbeye dayanıklı / shockproof

500x60x240 mm 0,66 kg 7.00 \$

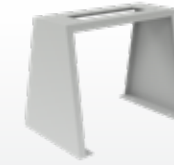

### POLİ 098

Metal Ayak  
Metal Base



- harici ortam / outdoor
- metal ayak / metal base

364x302x255 mm 2,43 kg 23.00 \$



### POLİ 099

Metal Ayak  
Metal Base



- harici ortam / outdoor
- metal ayak / metal base

464x302x255 mm 2,59 kg 26.00 \$





**POLİ 031**  
Kombinasyon Kutusu  
Combination Box

5 modül kapasiteli  
5 modules capacity

- siva üstü / surface mounted
- ABS gövde, PC kapak / ABS body, PC cover
- contalı kapak / gasket cover

120x220x110 mm 0,40 kg 6.00 \$



**POLİ 031-P1**  
Kombinasyon Kutusu  
Combination Box

5 modül + 1 adet 5x32A priz + 2 adet 1x16A priz  
5 modul + 1PCs 5x32A socket + 2 PCs 1x16A socket

- siva üstü / surface mounted
- ABS gövde, PC kapak / ABS body, PC cover
- contalı kapak / gasket cover

120x220x110 mm 0,50 kg 32.00 \$



**POLİ 031-P2**  
Kombinasyon Kutusu  
Combination Box

5 modül + 1 adet 3x25A priz + 2 adet 1x16A priz  
5 modul + 1PCs 3x25A socket + 2 PCs 1x16A socket

- siva üstü / surface mounted
- ABS gövde, PC kapak / ABS body, PC cover
- contalı kapak / gasket cover

120x220x110 mm 0,60 kg 19.00 \$



**POLİ 030**  
Kombinasyon Kutusu  
Combination Box

9 modül kapasiteli  
9 modules capacity

- siva üstü / surface mounted
- ABS gövde, PC kapak / ABS body, PC cover
- contalı kapak / gasket cover

230x290x125 mm 0,81 kg 11.00 \$



**POLİ 030-P4**  
Kombinasyon Kutusu  
Combination Box

9 modül + 2 adet 5x32A priz + 2 adet 1x16A priz  
9 modul + 2 PCs 5x32A socket + 2 PCs 1x16A socket

- siva üstü / surface mounted
- ABS gövde, PC kapak / ABS body, PC cover
- contalı kapak / gasket cover

230x290x125 mm 1,35 kg 57.00 \$



**POLİ 030-P5**  
Kombinasyon Kutusu  
Combination Box

9 modül + 2 adet 3x25A priz + 2 adet 1x16A priz  
9 modul + 2 PCs 3x25A socket + 2 PCs 1x16A socket

- siva üstü / surface mounted
- ABS gövde, PC kapak / ABS body, PC cover
- contalı kapak / gasket cover

230x290x125 mm 1,20 kg 31.00 \$



**POLİ 030-P6**  
Kombinasyon Kutusu  
Combination Box

9 modül + 2 adet 3x25A priz + 4 adet 1x16A priz  
9 modul + 2 PCs 3x25A socket + 4 PCs 1x16A socket

- siva üstü / surface mounted
- ABS gövde, PC kapak / ABS body, PC cover
- contalı kapak / gasket cover

230x290x125 mm 1,35 kg 37.00 \$



**POLİ 030-P7**  
Kombinasyon Kutusu  
Combination Box

9 modül + 2 adet 5x32A priz + 4 adet 1x16A priz  
9 modul + 2 PCs 5x32A socket + 4 PCs 1x16A socket

- siva üstü / surface mounted
- ABS gövde, PC kapak / ABS body, PC cover
- contalı kapak / gasket cover

230x290x125 mm 1,35 kg 64.00 \$



**POLİ K-30**  
Kombinasyon Kutusu  
Combination Box

15 modül kapasiteli  
15 modules capacity

- siva üstü / surface mounted
- ABS gövde, PC kapak / ABS body, PC cover
- contalı kapak / gasket cover

300x400x146 mm 1,86 kg 20.00 \$



**POLİ K-P1**  
Kombinasyon Kutusu  
Combination Box

15 modül + 3 adet 5x32A priz + 4 adet 1x16A priz  
15 modul + 3 PCs 5x32A socket + 4 PCs 1x16A socket

- siva üstü / surface mounted
- ABS gövde, PC kapak / ABS body, PC cover
- contalı kapak / gasket cover

300x400x146 mm 2,75 kg 94.00 \$



**POLİ K-P2**  
Kombinasyon Kutusu  
Combination Box

15 modül + 3 adet 3x25A priz + 4 adet 1x16A priz  
15 modul + 3 PCs 3x25A socket + 4 PCs 1x16A socket

- siva üstü / surface mounted
- ABS gövde, PC kapak / ABS body, PC cover
- contalı kapak / gasket cover

300x400x146 mm 2,20 kg 54.00 \$



**POLİ K-P3**  
Kombinasyon Kutusu  
Combination Box

15 modül + 2 adet 5x32A priz + 2 adet 3x25A priz + 4 adet 1x16A priz  
15 modul + 2 PCs 5x32A socket + 2 PCs 3x25A socket + 4 PCs 1x16A socket

- siva üstü / surface mounted
- ABS gövde, PC kapak / ABS body, PC cover
- contalı kapak / gasket cover

300x400x146 mm 2,20 kg 87.00 \$







**POLİ 032-1222**  
Buat Kutusu  
Junction Box

- siva üstü / surface mounted
- ABS gövde, ABS kapak / ABS body, ABS cover
- darbeye dayanıklı / shockproof
- çalışma sıcaklığı / operating heat -25°/ +60°



120x220x80 mm 0,25 kg 2.50 \$



**POLİ 032-1010**  
Buat Kutusu  
Junction Box

- siva üstü / surface mounted
- ABS gövde, ABS kapak / ABS body, ABS cover
- darbeye dayanıklı / shockproof
- çalışma sıcaklığı / operating heat -25°/ +60°



100x100x50 mm 0,12 kg 1.20 \$



**POLİ 032-1222-D**  
Buat Kutusu  
Junction Box

- siva üstü / surface mounted
- ABS gövde, ABS kapak / ABS body, ABS cover
- darbeye dayanıklı / shockproof
- çalışma sıcaklığı / operating heat -25°/ +60°



120x220x120 mm 0,33 kg 2.90 \$



**POLİ 032-1280**  
Buat Kutusu  
Junction Box

- siva üstü / surface mounted
- ABS gövde, ABS kapak / ABS body, ABS cover
- darbeye dayanıklı / shockproof
- çalışma sıcaklığı / operating heat -25°/ +60°



80x120x50 mm 0,12 kg 1.30 \$



**POLİ 032-2923**  
Buat Kutusu  
Junction Box

- siva üstü / surface mounted
- ABS gövde, ABS kapak / ABS body, ABS cover
- darbeye dayanıklı / shockproof
- çalışma sıcaklığı / operating heat -25°/ +60°



230x290x100 mm 0,55 kg 5.80 \$



**POLİ 032-1511**  
Buat Kutusu  
Junction Box

- siva üstü / surface mounted
- ABS gövde, ABS kapak / ABS body, ABS cover
- darbeye dayanıklı / shockproof
- çalışma sıcaklığı / operating heat -25°/ +60°



115x155x70 mm 0,20 kg 2.30 \$



**POLİ 032-1222-Ş**  
Buat Kutusu  
Junction Box

- siva üstü / surface mounted
- ABS gövde, PC kapak / ABS body, PC cover
- darbeye dayanıklı / shockproof
- çalışma sıcaklığı / operating heat -25°/ +60°



120x220x80 mm 0,26 kg 3.20 \$



**POLİ 032-2015**  
Buat Kutusu  
Junction Box

- siva üstü / surface mounted
- ABS gövde, ABS kapak / ABS body, ABS cover
- poliüretan dökme conta / polyurethane foam gasket
- darbeye dayanıklı / shockproof
- çalışma sıcaklığı / operating heat -25°/ +60°



155x205x80 mm 0,44 kg 5.20 \$



**POLİ 032-2923-Ş**  
Buat Kutusu  
Junction Box

- siva üstü / surface mounted
- ABS gövde, PC kapak / ABS body, PC cover
- darbeye dayanıklı / shockproof
- çalışma sıcaklığı / operating heat -25°/ +60°



230x290x100 mm 0,62 kg 7.40 \$



**POLİ 032-3023**  
Buat Kutusu  
Junction Box

- siva üstü / surface mounted
- ABS gövde, ABS kapak / ABS body, ABS cover
- poliüretan dökme conta / polyurethane foam gasket
- darbeye dayanıklı / shockproof
- çalışma sıcaklığı / operating heat -25°/ +60°



235x305x130 mm 1,02 kg 11.50 \$

# SAC PANOLAR METAL PANEL BOARDS

DKP diye adlandırılan 1-2 mm kalınlığında saclardan yapılır. Harici, dahili, duvar tipi, dolap tipi, sıva altı ve sıva üstü gibi birçok çeşit ve boyutlarda yapılmaktadır.

It is made of 1-2 mm thick sheets called DKP. It is made in many types and sizes such as external, Internal, wall type, cabinet type, flush mounted and surface mounted.

**YP 209**  
Taban Saçlı Pano  
Mounting Plate Enclosure

- sıva üstü / surface mounted
- 1 mm gövde / 1mm body
- giriş ve çıkış için özel kapama alanı / input and output cable plate
- sağa ve sola açılabilir kapı / door can be opened to left and right
- çalışma sıcaklığı / operating heat -25°/ +60°

250x300x165 mm 4,00 kg 42.00 \$

**YP 214**  
Taban Saçlı Pano  
Mounting Plate Enclosure

- sıva üstü / surface mounted
- 1 mm gövde / 1mm body
- giriş ve çıkış için özel kapama alanı / input and output cable plate
- sağa ve sola açılabilir kapı / door can be opened to left and right
- çalışma sıcaklığı / operating heat -25°/ +60°

600x700x270 mm 17,00 kg 150.00 \$

**YP 210**  
Taban Saçlı Pano  
Mounting Plate Enclosure

- sıva üstü / surface mounted
- 1 mm gövde / 1mm body
- giriş ve çıkış için özel kapama alanı / input and output cable plate
- sağa ve sola açılabilir kapı / door can be opened to left and right
- çalışma sıcaklığı / operating heat -25°/ +60°

300x400x175 mm 6,00 kg 47.00 \$

**YP 215**  
Taban Saçlı Pano  
Mounting Plate Enclosure

- sıva üstü / surface mounted
- 1 mm gövde / 1mm body
- giriş ve çıkış için özel kapama alanı / input and output cable plate
- sağa ve sola açılabilir kapı / door can be opened to left and right
- çalışma sıcaklığı / operating heat -25°/ +60°

600x800x270 mm 32,00 kg 170.00 \$

**YP 211**  
Taban Saçlı Pano  
Mounting Plate Enclosure

- sıva üstü / surface mounted
- 1 mm gövde / 1mm body
- giriş ve çıkış için özel kapama alanı / input and output cable plate
- sağa ve sola açılabilir kapı / door can be opened to left and right
- çalışma sıcaklığı / operating heat -25°/ +60°

400x500x215 mm 9,00 kg 85.00 \$

**YP 216**  
Taban Saçlı Pano  
Mounting Plate Enclosure

- sıva üstü / surface mounted
- 1 mm gövde / 1mm body
- giriş ve çıkış için özel kapama alanı / input and output cable plate
- sağa ve sola açılabilir kapı / door can be opened to left and right
- çalışma sıcaklığı / operating heat -25°/ +60°

600x1000x270 mm 40,00 kg 210.00 \$

**YP 212**  
Taban Saçlı Pano  
Mounting Plate Enclosure

- sıva üstü / surface mounted
- 1 mm gövde / 1mm body
- giriş ve çıkış için özel kapama alanı / input and output cable plate
- sağa ve sola açılabilir kapı / door can be opened to left and right
- çalışma sıcaklığı / operating heat -25°/ +60°

400x600x215 mm 12,00 kg 100.00 \$

**YP 217**  
Taban Saçlı Pano  
Mounting Plate Enclosure

- sıva üstü / surface mounted
- 1 mm gövde / 1mm body
- giriş ve çıkış için özel kapama alanı / input and output cable plate
- sağa ve sola açılabilir kapı / door can be opened to left and right
- çalışma sıcaklığı / operating heat -25°/ +60°

800x1000x270 mm 45,00 kg 310.00 \$

**YP 213**  
Taban Saçlı Pano  
Mounting Plate Enclosure

- sıva üstü / surface mounted
- 1 mm gövde / 1mm body
- giriş ve çıkış için özel kapama alanı / input and output cable plate
- sağa ve sola açılabilir kapı / door can be opened to left and right
- çalışma sıcaklığı / operating heat -25°/ +60°

500x600x215 mm 13,50 kg 115.00 \$

**YP 218**  
Taban Saçlı Pano  
Mounting Plate Enclosure

- sıva üstü / surface mounted
- 1 mm gövde / 1mm body
- giriş ve çıkış için özel kapama alanı / input and output cable plate
- sağa ve sola açılabilir kapı / door can be opened to left and right
- çalışma sıcaklığı / operating heat -25°/ +60°

800x1200x270 mm 13,50 kg 375.00 \$

**YP 101**Dağıtım Panosu  
Distribution Enclosure10 modül + pako yeri  
10 modules + selector switch

- siva üstü / surface mounted
- 1 mm gövde / 1 mm body
- çalışma sıcaklığı / operating heat -25°/ +60°

300x300x180 mm 5,00 kg 60.00 \$

**YP 106**Dağıtım Panosu  
Distribution Enclosure80 modül + pako yeri + klemens bölümü  
80 modules + selector switch + terminal section

- siva üstü / surface mounted
- 1 mm gövde / 1 mm body
- çalışma sıcaklığı / operating heat -25°/ +60°

650x900x180 mm 35,00 kg 235.00 \$

**YP 102**Dağıtım Panosu  
Distribution Enclosure20 modül + pako yeri + klemens bölümü  
20 modules + selector switch + terminal section

- siva üstü / surface mounted
- 1 mm gövde / 1 mm body
- çalışma sıcaklığı / operating heat -25°/ +60°

300x450x180 mm 7,00 kg 73.00 \$

**YP 107**Dağıtım Panosu  
Distribution Enclosure96 modül + pako yeri + klemens bölümü  
96 modules + selector switch + terminal section

- siva üstü / surface mounted
- 1 mm gövde / 1 mm body
- çalışma sıcaklığı / operating heat -25°/ +60°

700x900x180 mm 43,00 kg 250.00 \$

**YP 103**Dağıtım Panosu  
Distribution Enclosure30 modül + pako yeri + klemens bölümü  
30 modules + selector switch + terminal section

- siva üstü / surface mounted
- 1 mm gövde / 1 mm body
- çalışma sıcaklığı / operating heat -25°/ +60°

400x450x180 mm 11,00 kg 80.00 \$

**YP 108**Dağıtım Panosu  
Distribution Enclosure120 modül + pako yeri + klemens bölümü  
120 modules + selector switch + terminal section

- siva üstü / surface mounted
- 1 mm gövde / 1 mm body
- çalışma sıcaklığı / operating heat -25°/ +60°

750x900x180 mm 44,00 kg 265.00 \$

**YP 104**Dağıtım Panosu  
Distribution Enclosure45 modül + pako yeri + klemens bölümü  
45 modules + selector switch + terminal section

- siva üstü / surface mounted
- 1 mm gövde / 1 mm body
- çalışma sıcaklığı / operating heat -25°/ +60°

400x600x180 mm 13,00 kg 116.00 \$

**YP 045**Dağıtım Panosu  
Distribution EnclosureX/5 sayaç  
X/5 meter

- siva üstü / surface mounted
- 1,5 mm gövde / 1,5 mm body
- çalışma sıcaklığı / operating heat -25°/ +60°

600x960x220 mm 65,00 kg 312.00 \$

**YP 105**Dağıtım Panosu  
Distribution Enclosure60 modül + pako yeri + klemens bölümü  
60 modules + selector switch + terminal section

- siva üstü / surface mounted
- 1 mm gövde / 1 mm body
- çalışma sıcaklığı / operating heat -25°/ +60°

500x600x180 mm 19,00 kg 140.00 \$

**YP 046**Kompanzasyon Panosu  
Compensation Enclosure

- siva üstü / surface mounted
- 1 mm gövde / 1 mm body
- çalışma sıcaklığı / operating heat -25°/ +60°

600x1000x270 mm 65,11 kg 235.00 \$



**YPTK 012**  
Tünel Kalıp Sigorta Kutusu  
Tunnel Mold MCB Box**12'li W otomat kapasiteli**  
12 single MCB capacity

- siva altı / recessed mounted
- 1 mm gövde / 1 mm body
- çalışma sıcaklığı / operating heat -25°/ +60°

340x280x150 mm 9,40 kg Sorunuz

**YPTK 024**  
Tünel Kalıp Sigorta Kutusu  
Tunnel Mold MCB Box**24'lü W otomat kapasiteli**  
24 single MCB capacity

- siva altı / recessed mounted
- 1 mm gövde / 1 mm body
- çalışma sıcaklığı / operating heat -25°/ +60°

340x430x150 mm 11,00 kg Sorunuz

**YPTK 036**  
Tünel Kalıp Sigorta Kutusu  
Tunnel Mold MCB Box**36'lı W otomat kapasiteli**  
36 single MCB capacity

- siva altı / recessed mounted
- 1 mm gövde / 1 mm body
- çalışma sıcaklığı / operating heat -25°/ +60°

340x580x150 mm 13,00 kg Sorunuz

**YPTK 048**  
Tünel Kalıp Sigorta Kutusu  
Tunnel Mold MCB Box**48'li W otomat kapasiteli**  
48 single MCB capacity

- siva altı / recessed mounted
- 1 mm gövde / 1 mm body
- çalışma sıcaklığı / operating heat -25°/ +60°

410x580x150 mm 15,00 kg Sorunuz

**YPTK 060**  
Tünel Kalıp Sigorta Kutusu  
Tunnel Mold MCB Box**60'lı W otomat kapasiteli**  
60 single MCB capacity

- siva altı / recessed mounted
- 1 mm gövde / 1 mm body
- çalışma sıcaklığı / operating heat -25°/ +60°

510x580x150 mm 19,00 kg Sorunuz

**YPTK 080**  
Tünel Kalıp Sigorta Kutusu  
Tunnel Mold MCB Box**80'li W otomat kapasiteli**  
80 single MCB capacity

- siva altı / recessed mounted
- 1 mm gövde / 1 mm body
- çalışma sıcaklığı / operating heat -25°/ +60°

510x770x150 mm 22,00 kg Sorunuz

**Mağza ve Satış Alanları**  
Store and Sales Areas**Süpermarketler**  
Supermarkets**Koridorlar ve Geçiş Alanları**  
Hallways and Passageways**Toplantı Odaları**  
Meeting Rooms**Eğitim Kurumları**  
Educational Institutions**Ofisler**  
Offices**Yol ve Caddeler**  
Roads and Streets**Parklar ve çevresi**  
Parks and surroundings**Açık Otopark**  
Outdoor Parking**Kapalı Otopark**  
Parking Garage**Metro**  
Metro**Benzin istasyonları**  
petrol station**Hastane ve Sağlık Kurumları**  
Hospitals and Health Institutions**Havalimanları**  
Airports**Stadyum ve Halı Sahalar**  
Stadium and Astroturf Fields**Fabrika ve imalathane**  
Factory and Workshop**Depo**  
Warehouse**Limanlar**  
Ports**Kimyasal Ürün Üretimi Yapılan Fabrikalar**  
Factories Producing Chemical Products**Petrol Rafine ve Tesisleri**  
Petroleum Refineries and Facilities**Kömür Madenleri**  
Coal Mines**LED Aydınlatma Armatürü**  
LED Lighting Luminari**TSE Belgesi**  
TSE Certificate**Tüm Gövde Topraklaması**  
Entire Housing Earthing**CE Uygunluk Sertifikası**  
CE Conformity Marking**CB Kalite Sertifikası**  
CB Quality Certificate**Kema Decra Kalite Sertifikası**  
Kema Decra Quality Certificate**EN EC Kalite Belgesi**  
EN EC Quality Certificate**HF Halojen Free**  
Halogen Free**ATEX Patlayıcı Ortamlarda Güvenlik Belgesi**  
Explosive Atmospheres Safety Certificate**Ex Alev Sızdırmazlık Sertifikası**  
Fire Sealing Certificate**Geri Dönüşüm**  
Recycling**RoHS Tehlikeli Maddelerin Kısıtlanma Belgesi**  
Restriction Certificate of Hazardous Substances**IP 20 12 mm.'den daha büyük cisimlere karşı korumalı. Suya karşı korumasız.**  
IP 20 Protected against objects large than 12 mm. Not protected against water.**IP 40 1 mm.'den daha büyük katı karşı cisimlere korumalı. Suya karşı korumasız.**  
IP 40 Protected against solid objects larger than 1 mm. Not protected against water.**IP 44 1 mm.'den daha büyük cisimlere ve her yönden gelen suya karşı korumalı.**  
IP 44 Protected against objects large than 1mm and water from all directions.**IP 54 Toza karşı ve her yönden gelen, sıçrayan suya karşı korumalı. Suya karşı korumalı.**  
IP 54 Protected against dust and rapid, squirting water coming from all directions. Protected against water.**IP 55 Toza karşı ve her yönden gelen fıskıran, hızlı suya karşı korumalı.**  
IP 55 Protected against dust and rapid, squirting water coming from all directions.**IP 65 Toz geçirmez ve her yönden ve açıdan düşük basınçlı su jetine karşı korumalı.**  
IP 65 Dustproof and protected against pressurized water jet from all directions and anglws.**IP 66 Toz geçirmez ve her yönden gelebilecek yüksek tazyikteki sulara karşı korumalı.**  
IP 66 Dustproof and provides protection against high pressure water that can come from all directions.**IP 67 Toza ve 30 dakikadan kısa süreli suya daldırmalara karşı korumalı.**  
IP67 Protected against dust and immersion in water for less than 30 minutes.**IP 68 Belirtilen basınç ve sıcaklık değerleri altında toz ve suya karşı korumalı.**  
IP 68 Protected against dust and water under specified pressure and temperature values.



TSE EN 60598-2-1



TSE EN 60598-2-2



TSE EN 60598-2-3



TSE EN 60598-2-5



ISO 9001 ENG



ISO 9001 TR



ISO 14001 ENG



ISO 14001 TR



TS 18001



ENEC



CE



TSE EN 60670-24-60670-1



TSE EN 62208



ATEX BELGESİ



YERLİ MALİ BELGESİ



YERLİ MALİ BELGESİ

## AYDINLATMA KATALOĐU



## ÇEVRE AYDINLATMA KATALOĐU



## KABLO TAVALARI KATALOĐU

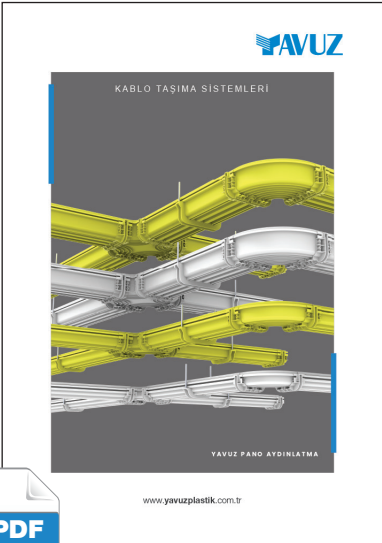

## SAC PANO KATALOĐU



**Yavuz Pano Aydınlatma A.Ş.**  
Cumhuriyet Mah. Selin Sok. No : 3  
Çayırova / Gebze / TÜRKİYE  
Tel: +90 262 658 15 11  
Fax: +90 262 658 15 12  
Mail: yavuzpano@yavuzpano.com.tr

