

Pelsan



2024/1
FİYAT LİSTESİ



Zone1, Zone21 ATEX Belgeli Ex-Proof Armatürler

Pelsan

- Toz Patlama Koruması: Zone 21
- Gaz Patlama Koruması: Zone 1

YENİ



Atarex

Projektör / Yüksek Tavan

- Gaz Patlama Koruması: Zone1
- Toz Patlama Koruması: Zone21
- II 2G Ex db IIB T4 Gb
- II 2D Ex tb IIIC T130° Db



Exta

Etanj / Yüksek Tavan

- Gaz Patlama Koruması: Zone1
- Toz Patlama Koruması: Zone21
- II 2G Ex db IIB T6 Gb
- II 2D Ex tb IIIC T85° Db



Diğer Ex-Proof Armatürleri



Largo LED
Etanj Armatür



Nairo
Projektör



Sia
Yüksek Tavan Armatürü



Nairo
Yol ve Cadde Armatürü

recta

art and light



yeni
Mimari Aydınlatma
Markamız



Fiyat Listesi için;

www.rectalighting.com



Pelsan Aydınlatma'nın mimari aydınlatma markasıdır.

İçindekiler

08 Backlight Ofis Armatürleri



09 Backlight Ofis Armatürleri



12 Ofis Armatürleri



14 Steril Ortam ve Hastane Armatürleri



17 Lineer Armatürler

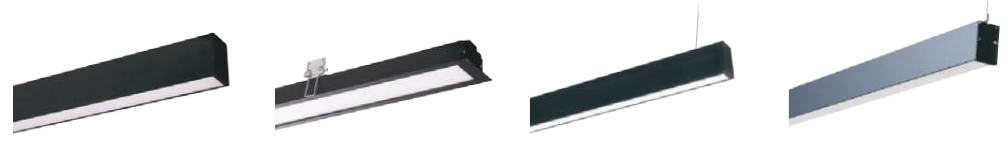

19 İç Mekan Gloplar



20 Downlight Armatürler



24 Tavan Armatürleri



İçindekiler

25 Sensörler



28 Acil Aydınlatma Armatürleri



29 Acil Aydınlatma ve Yönlendirme Armatürleri



31 Bant Armatürler



33 Etanj Armatürler



34 LED Tube Etanjlar LED Tube'ler



35 Benzinlik Armatürleri



36 Sabit Gerilim 24Vdc Armatürler



İçindekiler

37 24Vac/dc & 110Vac
Armatürler



38 Yüksek Tavan
Armatürleri



42 Alçak Tavan
Armatürleri



43 Ex-proof
Armatürler



47 Wallwasherlar



48 Yüksek Güçlü
Projektörler



51 Projektörler



52 Solar Aydınlatma
Armatürleri

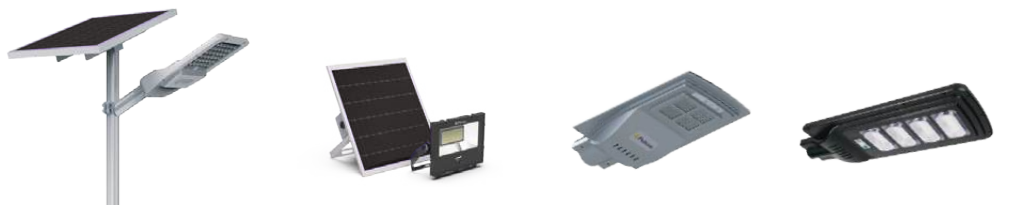

İçindekiler

54 Yol ve Cadde Armatürleri



57 Park Bahçe Aydınlatma Armatürleri



62 Direkler

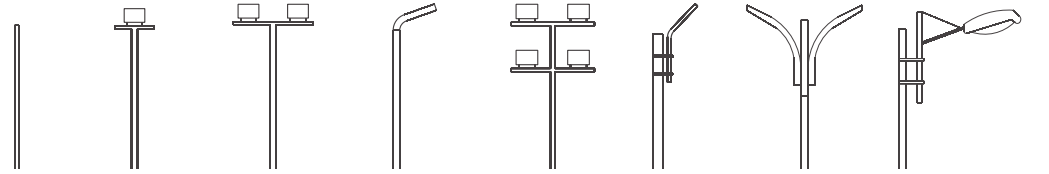

63 Bolardlar



66 Bahçe Armatürleri

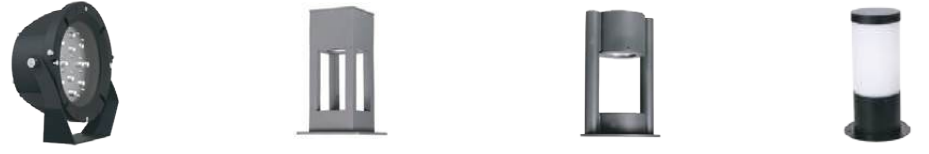

67 Dış Mekan Aplikler



59 Sertifikalar



Kurum Şartnamelerine Uygun

5 YIL GARANTİ



TSE TSE Belgeli



Avrupa Menşei ENEC Belgeli Sürücü



113 lm/W'a Varan Verimlilik



50.000 Saat Ömür



Tarak PCB



PF>0,95



PMMA Difüzör



55mm Kasa Kalınlığı



Isoled 60x60

Sıva Altı

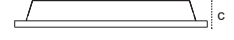

Kod	Güç (W)	Renk Sıcaklığı (K)	Işık Akısı (lm)	Etkinlik Faktörü (lm/W)	Boyutlar (mm)axbxc	Kesim Ölçüsü (mm)	Koli Ağırlığı (kg)	Koli Adedi	Fiyat
111411	36	4000	4068	113	595x595x61	570x570	23,5	6	51,30\$
111412	36	6500	4068	113	595x595x61	570x570	23,5	6	51,30\$

- Özellikler** Metal Opal Difüzör 3000/4000/6500K IP40 50.000h 5 Yıl
- Opsiyonlar** DALI 1-10V Acil Aydınlatma (1-3 saat) Clip-in Alçıpan



Isoled 30x30

Sıva Altı

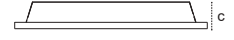

Kod	Güç (W)	Renk Sıcaklığı (K)	Işık Akısı (lm)	Etkinlik Faktörü (lm/W)	Boyutlar (mm)axbxc	Kesim Ölçüsü (mm)	Koli Ağırlığı (kg)	Koli Adedi	Fiyat
111342	12	4000	1236	103	295x295x61	270x270	7	5	25,80\$
111343	12	6500	1236	103	295x295x61	270x270	7	5	25,80\$

- Özellikler** Metal Opal Difüzör 3000/4000/6500K IP40 50.000h 5 Yıl
- Opsiyonlar** DALI 1-10V Acil Aydınlatma (1-3 saat) Clip-in Alçıpan

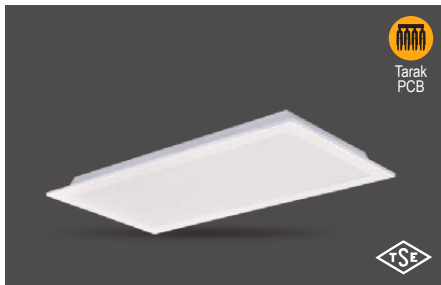

Isoled 30x60

Sıva Altı

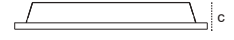

Kod	Güç (W)	Renk Sıcaklığı (K)	Işık Akısı (lm)	Etkinlik Faktörü (lm/W)	Boyutlar (mm)axbxc	Kesim Ölçüsü (mm)	Koli Ağırlığı (kg)	Koli Adedi	Fiyat
111461	17	4000	1785	105	595x295x61	570x270	12,54	5	44,10\$
111462	17	6500	1785	105	595x295x61	570x270	12,54	5	44,10\$

- Özellikler** Metal Opal Difüzör 3000/4000/6500K IP40 50.000h 5 Yıl
- Opsiyonlar** DALI 1-10V Acil Aydınlatma (1-3 saat) Alçıpan



Isoled 30x120

Sıva Altı

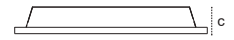

Kod	Güç (W)	Renk Sıcaklığı (K)	Işık Akısı (lm)	Etkinlik Faktörü (lm/W)	Boyutlar (mm)axbxc	Kesim Ölçüsü (mm)	Koli Ağırlığı (kg)	Koli Adedi	Fiyat
111464	36	4000	3960	110	1195x295x61	1170x270	12,8	4	68,80\$
111465	36	6500	3960	110	1195x295x61	1170x270	12,8	4	68,80\$

- Özellikler** Metal Opal Difüzör 3000/4000/6500K IP40 50.000h 5 Yıl
- Opsiyonlar** DALI 1-10V Acil Aydınlatma (1-3 saat) Alçıpan

Opsiyonlar

Kod	Özellikler	Koli Adedi	Fiyat
327764	Isoled & Dekoled Acil Aydınlatma Kiti (1 saat)	1	27,60\$
327251	Isoled & Dekoled Acil Aydınlatma Kiti (3 saat)	1	31,60\$
323795	Isoled Alçıpan Yayı (4 adet) (60x60 için)	1	3,70\$
325628	Isoled Alçıpan Yayı (2 adet) (30x30 için)	1	1,85\$

Özellikler	Koli Adedi	Fiyat
1-10V Dim	1	31,25\$
DALI Dim	1	31,25\$
PMMA Difüzör	1	6,50\$





Dekoled 60x60

Sıva Üstü

Kod	Güç (W)	Renk Sıcaklığı (K)	Işık Akısı (lm)	Etkinlik Faktörü (lm/W)	Boyutlar (mm)axbxc	Koli Ağırlığı (kg)	Koli Adedi	Fiyat
111439	36	4000	4068	113	600x600x61	25,6	6	59,60\$
111440	36	6500	4068	113	600x600x61	25,6	6	59,60\$

Özellikler	Metal	Opal Difüzör	3000/4000/6500K	IP40	50.000h	5 Yıl
Opsiyonlar	DALI	1-10V	Acil Aydınlatma (1-3 saat)			



Dekoled 30x30

Sıva Üstü

Kod	Güç (W)	Renk Sıcaklığı (K)	Işık Akısı (lm)	Etkinlik Faktörü (lm/W)	Boyutlar (mm)axbxc	Koli Ağırlığı (kg)	Koli Adedi	Fiyat
111357	12	4000	1236	103	308x308x51	6,2	5	30,00\$
111358	12	6500	1236	103	308x308x51	6,2	5	30,00\$

Özellikler	Metal	Opal Difüzör	3000/4000/6500K	IP40	50.000h	5 Yıl
Opsiyonlar	DALI	1-10V	Acil Aydınlatma (1-3 saat)			



Dekoled 30x60

Sıva Üstü

Kod	Güç (W)	Renk Sıcaklığı (K)	Işık Akısı (lm)	Etkinlik Faktörü (lm/W)	Boyutlar (mm)axbxc	Koli Ağırlığı (kg)	Koli Adedi	Fiyat
111455	17	4000	1785	105	308x600x61	11	5	50,40\$
111456	17	6500	1785	105	308x600x61	11	5	50,40\$

Özellikler	Metal	Opal Difüzör	3000/4000/6500K	IP40	50.000h	5 Yıl
Opsiyonlar	DALI	1-10V	Acil Aydınlatma (1-3 saat)			



Dekoled 30x120

Sıva Üstü

Kod	Güç (W)	Renk Sıcaklığı (K)	Işık Akısı (lm)	Etkinlik Faktörü (lm/W)	Boyutlar (mm)axbxc	Koli Ağırlığı (kg)	Koli Adedi	Fiyat
111458	36	4000	3960	110	308x1200x61	20,5	4	79,80\$
111459	36	6500	3960	110	308x1200x61	20,5	4	79,80\$

Özellikler	Metal	Opal Difüzör	3000/4000/6500K	IP40	50.000h	5 Yıl
Opsiyonlar	DALI	1-10V	Acil Aydınlatma (1-3 saat)			



Dekoled 60x120

Sıva Üstü

Kod	Güç (W)	Renk Sıcaklığı (K)	Işık Akısı (lm)	Etkinlik Faktörü (lm/W)	Boyutlar (mm)axbxc	Koli Ağırlığı (kg)	Koli Adedi	Fiyat
113392	72	4000	7200	100	600x1200x61	4,8	1	145,80\$
113393	72	6500	7200	100	600x1200x61	4,8	1	145,80\$

Özellikler	Metal	Opal Difüzör	3000/4000/6500K	IP40	50.000h	5 Yıl
Opsiyonlar	DALI	1-10V	Acil Aydınlatma (1-3 saat)			

Kurum Şartnamelerine Uygun

TSE TSE Belgeli

ENEC ENEC Belgeli Sürücü

50.000 Saatlik Ömür

Lensli Modül

PF PF>0,95

5
YIL
GARANTİ



Isoled 60x60

Sıva Altı

Kod	Güç (W)	Renk Sıcaklığı (K)	Işık Akısı (lm)	Etkinlik Faktörü (lm/W)	Boyutlar (mm)axbxc	Kesim Ölçüsü (mm)	Koli Ağırlığı (kg)	Koli Adedi	Fiyat
111474	36	4000	3708	103	595x595x45	570x570	22,5	6	40,00\$
111475	36	6500	3708	103	595x595x45	570x570	22,5	6	40,00\$

- Özellikler** Metal, Opal Difüzör, 3000/4000/6500K, IP40, 50.000h, 5 Yıl
- Opsiyonlar** DALI, 1-10V, Acil Aydınlatma (1-3 saat), Clip-in, Alçıpan



Isoled 30x30

Sıva Altı

Kod	Güç (W)	Renk Sıcaklığı (K)	Işık Akısı (lm)	Etkinlik Faktörü (lm/W)	Boyutlar (mm)axbxc	Kesim Ölçüsü (mm)	Koli Ağırlığı (kg)	Koli Adedi	Fiyat
115346	12	4000	1200	100	295x295x45	270x270	7	5	18,40\$
115347	12	6500	1200	100	295x295x45	270x270	7	5	18,40\$

- Özellikler** Metal, Opal Difüzör, 3000/4000/6500K, IP40, 50.000h, 5 Yıl
- Opsiyonlar** DALI, 1-10V, Acil Aydınlatma (1-3 saat), Clip-in, Alçıpan

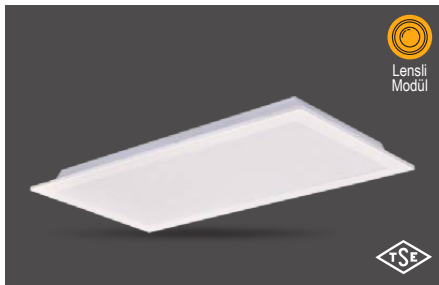

Isoled 30x60

Sıva Altı

Kod	Güç (W)	Renk Sıcaklığı (K)	Işık Akısı (lm)	Etkinlik Faktörü (lm/W)	Boyutlar (mm)axbxc	Kesim Ölçüsü (mm)	Koli Ağırlığı (kg)	Koli Adedi	Fiyat
111821	17	4000	1700	100	595x295x45	270x570	11,4	6	34,10\$
111822	17	6500	1700	100	595x295x45	270x570	11,4	6	34,10\$

- Özellikler** Metal, Opal Difüzör, 3000/4000/6500K, IP40, 50.000h, 5 Yıl
- Opsiyonlar** DALI, 1-10V, Acil Aydınlatma (1-3 saat), Clip-in, Alçıpan



Isoled 30x120

Sıva Altı

Kod	Güç (W)	Renk Sıcaklığı (K)	Işık Akısı (lm)	Etkinlik Faktörü (lm/W)	Boyutlar (mm)axbxc	Kesim Ölçüsü (mm)	Koli Ağırlığı (kg)	Koli Adedi	Fiyat
113008	36	4000	3708	103	1195x295x45	270x1170	12,8	4	54,40\$
113009	36	6500	3708	103	1195x295x45	270x1170	12,8	4	54,40\$

- Özellikler** Metal, Opal Difüzör, 3000/4000/6500K, IP40, 50.000h, 5 Yıl
- Opsiyonlar** DALI, 1-10V, Acil Aydınlatma (1-3 saat), Clip-in, Alçıpan

Opsiyonlar

Kod	Özellikler	Koli Adedi	Fiyat
327764	Isoled & Dekoled Acil Aydınlatma Kiti (1 saat)	1	27,60\$
327251	Isoled & Dekoled Acil Aydınlatma Kiti (3 saat)	1	31,60\$
323795	Isoled Alçıpan Yayı (4 adet) (60x60 için)	1	3,70\$
325628	Isoled Alçıpan Yayı (2 adet) (30x30 için)	1	1,85\$

Özellikler	Koli Adedi	Fiyat
1-10V Dim	1	31,25\$
DALI Dim	1	31,25\$
PMMA Difüzör	1	6,50\$





Dekoled 60x60

Sıva Üstü

Kod	Güç (W)	Renk Sıcaklığı (K)	Işık Akısı (lm)	Etkinlik Faktörü (lm/W)	Boyutlar (mm)axbxc	Koli Ağırlığı (kg)	Koli Adedi	Fiyat
111499	36	4000	3708	103	600x600x61	24,6	6	46,80\$
111500	36	6500	3708	103	600x600x61	24,6	6	46,80\$

Özellikler	 Metal	 Opal Difüzör	 3000/4000/6500K	 IP40	 50.000h	 5 Yıl
Opsiyonlar	 DALI	 1-10V	 Acil Aydınlatma (1-3 saat)			



Dekoled 30x30

Sıva Üstü

Kod	Güç (W)	Renk Sıcaklığı (K)	Işık Akısı (lm)	Etkinlik Faktörü (lm/W)	Boyutlar (mm)axbxc	Koli Ağırlığı (kg)	Koli Adedi	Fiyat
115827	12	4000	1200	100	308x308x51	6,2	5	21,65\$
116110	12	6500	1200	100	308x308x51	6,2	5	21,65\$

Özellikler	 Metal	 Opal Difüzör	 3000/4000/6500K	 IP40	 50.000h	 5 Yıl
Opsiyonlar	 DALI	 1-10V	 Acil Aydınlatma (1-3 saat)			



Dekoled 30x60

Sıva Üstü

Kod	Güç (W)	Renk Sıcaklığı (K)	Işık Akısı (lm)	Etkinlik Faktörü (lm/W)	Boyutlar (mm)axbxc	Koli Ağırlığı (kg)	Koli Adedi	Fiyat
111839	17	4000	1700	100	308x600x61	10,3	5	40,00\$
111840	17	6500	1700	100	308x600x61	10,3	5	40,00\$

Özellikler	 Metal	 Opal Difüzör	 3000/4000/6500K	 IP40	 50.000h	 5 Yıl
Opsiyonlar	 DALI	 1-10V	 Acil Aydınlatma (1-3 saat)			



Dekoled 30x120

Sıva Üstü

Kod	Güç (W)	Renk Sıcaklığı (K)	Işık Akısı (lm)	Etkinlik Faktörü (lm/W)	Boyutlar (mm)axbxc	Koli Ağırlığı (kg)	Koli Adedi	Fiyat
113041	36	4000	3708	103	308x1200x61	20,5	4	63,70\$
113042	36	6500	3708	103	308x1200x61	20,5	4	63,70\$

Özellikler	 Metal	 Opal Difüzör	 3000/4000/6500K	 IP40	 50.000h	 5 Yıl
Opsiyonlar	 DALI	 1-10V	 Acil Aydınlatma (1-3 saat)			



Dekoled 60x120

Sıva Üstü

Kod	Güç (W)	Renk Sıcaklığı (K)	Işık Akısı (lm)	Etkinlik Faktörü (lm/W)	Boyutlar (mm)axbxc	Koli Ağırlığı (kg)	Koli Adedi	Fiyat
113353	72	4000	7200	100	600x1200x61	4,8	1	140,70\$
113354	72	6500	7200	100	600x1200x61	4,8	1	140,70\$

Özellikler	 Metal	 Opal Difüzör	 3000/4000/6500K	 IP40	 50.000h	 5 Yıl
Opsiyonlar	 DALI	 1-10V	 Acil Aydınlatma (1-3 saat)			

Dealed

Ekonomik Çözüm
Dealed!



Dealed 60x60
Sıva Altı



Dealed 60x60
Sıva Üstü



Dealed 60x60

Sıva Altı

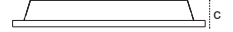

Kod	Güç (W)	Renk Sıcaklığı (K)	Işık Akısı (lm)	Etkinlik Faktörü (lm/W)	Boyutlar (mm)axbxc	Kesim Ölçüsü (mm)	Koli Ağırlığı (kg)	Koli Adedi	Fiyat
113850	36	4000	3708	103	595x595x33	570x570	15	10	28,80\$
113851	36	6500	3708	103	595x595x33	570x570	15	10	28,80\$

- Özellikler**
- Metal
 - Opal Difüzör
 - 3000/4000/6500K
 - IP40
 - 50.000h
- Opsiyonlar**
- Acil Aydınlatma (1-3 saat)
 - Clip-in
 - Alçıpan



Dealed 60x60

Sıva Üstü



Kod	Güç (W)	Renk Sıcaklığı (K)	Işık Akısı (lm)	Etkinlik Faktörü (lm/W)	Boyutlar (mm)axbxc	Koli Ağırlığı (kg)	Koli Adedi	Fiyat
115699	36	4000	3708	103	595x595x67	15	6	34,20\$
115700	36	6500	3708	103	595x595x67	15	6	34,20\$

- Özellikler**
- Metal
 - Opal Difüzör
 - 3000/4000/6500K
 - IP40
 - 50.000h
- Opsiyonlar**
- Acil Aydınlatma (1-3 saat)





Clip-in Isoled 30x30

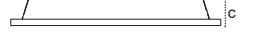

Kod	Güç (W)	Renk Sıcaklığı (K)	Işık Akısı (lm)	Etkinlik Faktörü (lm/W)	Boyutlar (mm)axbxc	Koli Ağırlığı (kg)	Koli Adedi	Fiyat
111582	12	4000	1200	100	300x300x55	7	5	26,50\$
111583	12	6500	1200	100	300x300x55	7	5	26,50\$

Özellikler	Metal	Opal Difüzör	3000/4000/6500K	IP40	50.000h	5 Yıl
Opsiyonlar	DALI	1-10V	Acil Aydınlatma (1-3 saat)	Clip-in	Alçıpan	



Clip-in Isoled 60x60

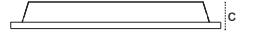

Kod	Güç (W)	Renk Sıcaklığı (K)	Işık Akısı (lm)	Etkinlik Faktörü (lm/W)	Boyutlar (mm)axbxc	Koli Ağırlığı (kg)	Koli Adedi	Fiyat
111480	36	4000	3708	103	600x600x55	22,5	6	43,30\$
111481	36	6500	3708	103	600x600x55	22,5	6	43,30\$

Özellikler	Metal	Opal Difüzör	3000/4000/6500K	IP40	50.000h	5 Yıl
Opsiyonlar	DALI	1-10V	Acil Aydınlatma (1-3 saat)	Clip-in	Alçıpan	



Clip-in Clealed 30x30

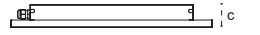

Kod	Güç (W)	Renk Sıcaklığı (K)	Işık Akısı (lm)	Etkinlik Faktörü (lm/W)	Boyutlar (mm)axbxc	Koli Ağırlığı (kg)	Koli Adedi	Fiyat
113657	12	4000	1416	118	300x300x50	7	5	42,40\$
113658	12	6500	1416	118	300x300x50	7	5	42,40\$

Özellikler	Metal	Opal Difüzör	3000/4000/6500K	IP65	50.000h	5 Yıl
Opsiyonlar	DALI	1-10V	Acil Aydınlatma (1-3 saat)	Clip-in	Alçıpan	



Clip-in Clealed 60x60

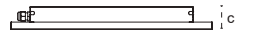

Kod	Güç (W)	Renk Sıcaklığı (K)	Işık Akısı (lm)	Etkinlik Faktörü (lm/W)	Boyutlar (mm)axbxc	Koli Ağırlığı (kg)	Koli Adedi	Fiyat
113261	36	4000	4464	124	600x600x50	15	5	71,90\$
111622	36	6500	4464	124	600x600x50	15	5	71,90\$

Özellikler	Metal	Opal Difüzör	3000/4000/6500K	IP65	50.000h	5 Yıl
Opsiyonlar	DALI	1-10V	Acil Aydınlatma (1-3 saat)	Clip-in	Alçıpan	

Endirekt Steril



Kamaşma Önleyici
Tasarım UGR<16



Temperli
Cam



IP65,
Toz ve Su Almaz



IP65 LED Steril

Sıva Altı Temperli Camlı

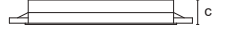

Kod	Güç (W)	Renk Sıcaklığı (K)	Işık Akısı (lm)	Etkinlik Faktörü (lm/W)	Boyutlar (mm)axbxc	Kesim Ölçüsü (mm)	Koli Ağırlığı (kg)	Koli Adedi	Fiyat
109776	36	4000	3240	90	595x595x92	580x580	-	2	108,10\$
109777	36	6500	3240	90	595x595x92	580x580	-	2	108,10\$

Özellikler	Malzeme	Cam Türü	Renk Sıcaklığı	IP Sınıfı	Ömür
Özellikler	Metal	Temperli Cam	3000/4000/6500K	IP65	50.000h
Opsiyonlar	DALI	1-10V	Acil Aydınlatma (1-3 saat)	Alçıpan	Sıva Üstü



IP65 LED Steril

Sıva Üstü Temperli Camlı



Kod	Güç (W)	Renk Sıcaklığı (K)	Işık Akısı (lm)	Etkinlik Faktörü (lm/W)	Boyutlar (mm)axbxc	Kesim Ölçüsü (mm)	Koli Ağırlığı (kg)	Koli Adedi	Fiyat
109905	36	4000	3240	90	600x600x100	580x580	13	2	119,30\$
109906	36	6500	3240	90	600x600x100	580x580	13	2	119,30\$

Özellikler	Malzeme	Cam Türü	Renk Sıcaklığı	IP Sınıfı	Ömür
Özellikler	Metal	Temperli Cam	3000/4000/6500K	IP65	50.000h
Opsiyonlar	DALI	1-10V	Acil Aydınlatma (1-3 saat)	Alçıpan	Sıva Üstü



Yeni Ürün

Endirekt Steril 60x60

Sıva Altı



Kod	Güç (W)	Renk Sıcaklığı (K)	Işık Akısı (lm)	Etkinlik Faktörü (lm/W)	Boyutlar (mm)axbxc	Kesim Ölçüsü (mm)	Koli Ağırlığı (kg)	Koli Adedi	Fiyat
113439	42	4000	3150	75	595x595x92	580x580	13	1	144,20\$
113440	42	6500	3150	75	595x595x92	580x580	13	1	144,20\$

Özellikler	Malzeme	Cam Türü	Renk Sıcaklığı	IP Sınıfı	Ömür
Özellikler	Metal	Opal Difüzör	3000/4000/6500K	IP65	50.000h
Opsiyonlar	DALI	1-10V	Acil Aydınlatma (1-3 saat)	Alçıpan	





IP65,
Toz ve Su Almaz

Opal
Difüzör

Sıva Altı, Sıva Üstü,
Alçıpan Seçenekleri

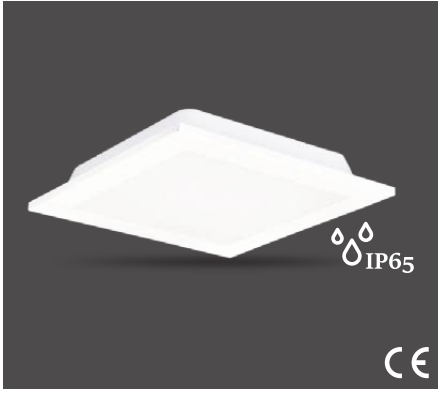

Cleared IP65 60x60

Sıva Altı



Kod	Güç (W)	Renk Sıcaklığı (K)	Işık Akısı (lm)	Etkinlik Faktörü (lm/W)	Boyutlar (mm)axbxc	Kesim Ölçüsü (mm)	Koli Ağırlığı (kg)	Koli Adedi	Fiyat
113277	36	4000	3708	103	595x595x45	580x580	18	6	68,60\$
113278	36	6500	3708	103	595x595x45	580x580	18	6	68,60\$

Özellikler	Metel	Opal Difüzör	3000/4000/6500K	IP65	50.000h
Opsiyonlar	DALI	1-10V	Acil Aydınlatma (1-3 saat)	Clip-in	Alçıpan

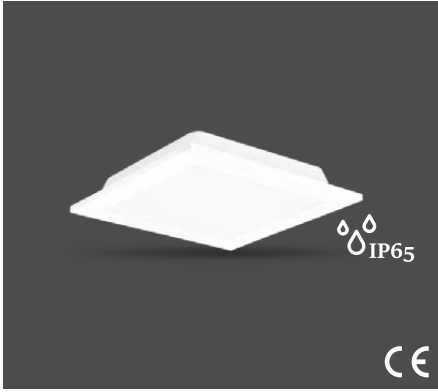

Cleared IP65 30x30

Sıva Altı

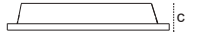

Kod	Güç (W)	Renk Sıcaklığı (K)	Işık Akısı (lm)	Etkinlik Faktörü (lm/W)	Boyutlar (mm)axbxc	Kesim Ölçüsü (mm)	Koli Ağırlığı (kg)	Koli Adedi	Fiyat
113695	12	4000	1416	118	295x295x61	280x280	7	5	39,10\$
113696	12	6500	1416	118	295x295x61	280x280	7	5	39,10\$

Özellikler	Metel	Opal Difüzör	3000/4000/6500K	IP65	50.000h
Opsiyonlar	DALI	1-10V	Acil Aydınlatma (1-3 saat)	Clip-in	Alçıpan

Yeni Ürün



Tira S IP54/IP65

Sıva Altı

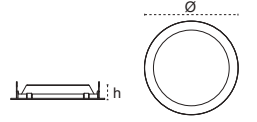

Kod	Güç (W)	Renk Sıcaklığı (K)	Işık Akısı (lm)	Etkinlik Faktörü (lm/W)	Boyutlar (mm)Øxh	Kesim Ölçüsü (mm)	Koli Ağırlığı (kg)	Koli Adedi	Fiyat
210185	10	4000	1000	100	110x41	100	12,6	60	36,30\$
210189	15	4000	1860	124	175x41	165	12,4	24	45,30\$
210191	20	4000	2440	122	175x41	165	12,4	24	46,70\$
210199	20	4000	2460	123	225x41	215	13,3	24	62,10\$
210201	25	4000	3050	122	225x41	215	13,3	18	65,10\$
210203	35	4000	4235	121	225x41	215	13,3	18	73,75\$

Özellikler	Alüminyum	Opal Difüzör	3000/4000/6500K	IP54 / IP65	50.000h	5 Yıl
Opsiyonlar	DALI	1-10V	Acil Aydınlatma (1-3 saat)	RAL 9005		

Fertis

- 150m/W'a Varan Verimlilik
- Güç Çeşitliliği: 25 / 28 / 36W
- UGR<19 Opsiyon
- CRI>90 Seçeneği
- 5 Yıl Garanti



Yeni Ürün



Fertis
Sıva Altı

150lm/W'a
Varan Verimlilik



Kod	Tip	Güç (W)	Renk Sıcaklığı (K)	Işık Akısı (lm)	Etkinlik Faktörü (lm/W)	Boyutlar (mm)axbxc	Kesim Ölçüsü (mm)	Koli Ağırlığı (kg)	Koli Adedi	Fiyat
115460	CRI80	36	4000	5220	145	595x595x33	570x570	15,1	10	48,00\$
115457	CRI80+UGR<19	36	4000	4860	135	595x595x33	570x570	15,1	10	52,00\$

- Özellikler
- Metal
 - Opal Difüzör
 - 3000/4000/6500K
 - IP40
 - 50.000h
- Opsiyonlar
- DALI
 - 1-10V
 - Acil Aydınlatma (1-3 saat)
 - Clip-in
 - Alçıpan



Divaled Endirekt
Sıva Altı / Sıva Üstü

Kamaşma Önleyici
Tasarım UGR<19

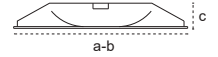

Kod	Tip	Güç (W)	Renk Sıcaklığı (K)	Işık Akısı (lm)	Etkinlik Faktörü (lm/W)	Boyutlar (mm)axbxc	Kesim Ölçüsü (mm)	Koli Ağırlığı (kg)	Koli Adedi	Fiyat
108125	Sıva Altı	42	4000	2940	70	595x595x72	580x580	16,36	4	76,50 \$
108408	Sıva Altı	42	6500	2940	70	595x595x72	580x580	16,36	4	76,50 \$
110601	Sıva Üstü	42	4000	2940	70	595x595x72	-	16,36	4	91,80 \$
110602	Sıva Üstü	42	6500	2940	70	595x595x72	-	16,36	4	91,80 \$

- Özellikler
- Metal
 - Opal Difüzör
 - 3000/4000/6500K
 - IP40
 - 50.000h
- Opsiyonlar
- DALI
 - 1-10V
 - Acil Aydınlatma (1-3 saat)
 - Clip-in
 - Alçıpan
 - Sıva Üstü



Sonsuz Lineer Bağlantı

Bağlantı aparatları ile ürüne müdahale edilmeksizin dışardan kesintisiz lineer bağlantı yapılır.

RAL 9005

RAL 9006

RAL 9016

Linna

Eterna

• LED Çip (LM80-TM218) • ENEC Belgeli Sürücü • Acil Aydınlatma • DALI Opsiyonu

Linna

Sıva Üstü



Kod	Güç (W)	Renk Sıcaklığı (K)	Işık Akısı (lm)	Etkinlik Faktörü (lm/W)	Boyutlar (mm)axbxc	Koli Ağırlığı (kg)	Koli Adedi	Fiyat
209137	20	4000	2000	100	50x70x500	19,2	24	30,60\$
209139	36	4000	3600	100	50x70x1000	19,1	12	61,20\$
209140	56	4000	5600	100	50x70x1500	27	12	91,80\$

Özellikler	Alüminyum	Opal Difüzör	3000/4000/6500K	IP40	50.000h
Opsiyonlar	DALI	1-10V	Acil Aydınlatma (1-3 saat)	Through Wiring	RAL 9016

Linna T-X-L Bağlantı Armatürleri

Sıva Üstü

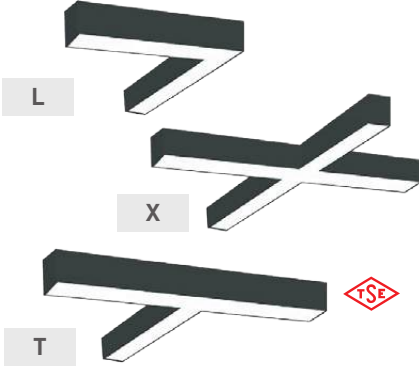
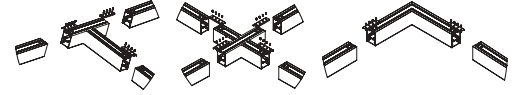

Kod	Tip	Güç (W)	Renk Sıcaklığı (K)	Işık Akısı (lm)	Etkinlik Faktörü (lm/W)	Boyutlar (mm)axbxc	Koli Ağırlığı (kg)	Koli Adedi	Fiyat
209739	L	20	4000	2000	100	270x70x290	0,598	1	35,60\$
209736	T	20	4000	2000	100	250x70x300	0,595	1	38,60\$
209742	X	20	4000	2000	100	250x70x300	0,77	1	45,55\$

Özellikler	Alüminyum	Opal Difüzör	3000/4000/6500K	IP40	50.000h	Through Wiring
Opsiyonlar	DALI	1-10V	RAL 9016			

Eterna

Sıva Altı

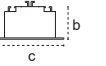

Kod	Güç (W)	Renk Sıcaklığı (K)	Işık Akısı (lm)	Etkinlik Faktörü (lm/W)	Boyutlar (mm)axbxc	Kesim Ölçüsü (mm)	Koli Ağırlığı (kg)	Koli Adedi	Fiyat
108898	14	4000	1260	90	640x77x85	620x62	1,15	1	44,40\$
108899	20	4000	1800	90	920x77x85	900x62	1,47	1	58,70\$
108900	28	4000	2520	90	1240x77x85	1220x62	1,77	1	71,40\$
108901	42	4000	3780	90	1520x77x85	1500x62	2,15	1	95,50\$

Özellikler	Alüminyum	Opal Difüzör	3000/4000/6500K	IP40	50.000h
Opsiyonlar	DALI	1-10V	RAL 9016		

Kod	Özellikler	Koli Adedi	Fiyat
304906	Askı Aparatı 100 cm (2 adet)	1	4,60 \$
304915	Askı Aparatı 150 cm (2 adet)	1	5,60 \$
317986	Askı Ronans Takımı 150 cm Siyah (2 Adet)	1	5,60 \$
209870	Lineer Birleştirme Aparatı Takımı (2 Adet)	1	2,60 \$

Trenta

ŞOK FİYAT
40,30\$



Trenta G2 (33mm)

Sıva Üstü

Kod	Güç (W)	Renk Sıcaklığı (K)	Işık Akısı (lm)	Etkinlik Faktörü (lm/W)	Boyutlar (mm)axbxc	Koli Ağırlığı (kg)	Koli Adedi	Fiyat
113031	36	4000	3060	85	1020x33x60	12	12	40,30\$

Özellikler	Alüminyum	Opal Difüzör	4000K	IP40	36.000h
Opsiyonlar	Acil Aydınlatma (1-3 saat)				

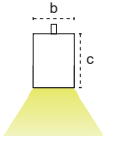

Eterna Endirekt (47mm)

Sıva Üstü

Kod	Güç (W)	Renk Sıcaklığı (K)	Işık Akısı (lm)	Etkinlik Faktörü (lm/W)	Boyutlar (mm)axbxc	Koli Ağırlığı (kg)	Koli Adedi	Fiyat
206015	26-16	4000	2600-1440	100-90	900x47x85	-	1	124,00\$
206016	34-18	4000	3400-1620	100-90	1200x47x85	-	1	137,20\$
206017	44-24	4000	4400-2160	100-90	1470x47x85	-	1	163,00\$
206018	60-40	4000	6000-3600	100-90	2000x47x85	-	1	229,10\$

Özellikler	Alüminyum	Opal Difüzör	3000/4000/6500K	IP40	50.000h
Opsiyonlar	DALI	1-10V	Acil Aydınlatma (1-3 saat)	RAL 9016	

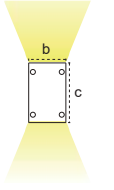

Lorenta (33mm)

Sıva Üstü

Kod	Güç (W)	Renk Sıcaklığı (K)	Işık Akısı (lm)	Etkinlik Faktörü (lm/W)	Boyutlar (mm)axbxc	Koli Ağırlığı (kg)	Koli Adedi	Fiyat
111384	16	4000	1600	100	570x33x58	-	1	52,30\$
111385	32	4000	3200	100	1200x33x58	-	1	75,00\$
111386	42	4000	4200	100	1500x33x58	-	1	85,20\$
111387	56	4000	5600	100	1980x33x58	-	1	107,70\$

Özellikler	Alüminyum	Opal Difüzör	3000/4000/6500K	IP40	50.000h
Opsiyonlar	DALI	1-10V	Acil Aydınlatma (1-3 saat)	RAL 9016	

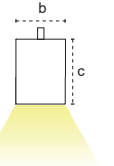



**KURUM ŞARTNAMESİNE
UYGUN!**

- 108lm/W'a Varan Verimlilik
- 50.000 Saat Ömür
- PF > 0,95
- Opal Cam
- ENEC Belgeli Sürücü



Yeni Ürün



Sense G2 (E27)

Kod	Tip	Güç (W)	Renk Sıcaklığı (K)	Işık Akısı (lm)	Etkinlik Faktörü (lm/W)	Boyutlar (mm)Øxh	Koli Ağırlığı (kg)	Koli Adedi	Fiyat
115372	E27	-	-	-	-	281x86	10	10	10,30\$
115373	E27 Sensörlü	-	-	-	-	281x86	10	10	26,60\$

Özellikler Metal Opal Cam 6500K IP40 50.000h

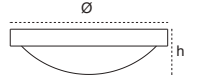

Yeni Ürün



Sense G2 (LED)

Kod	Tip	Güç (W)	Renk Sıcaklığı (K)	Işık Akısı (lm)	Etkinlik Faktörü (lm/W)	Boyutlar (mm)Øxh	Koli Ağırlığı (kg)	Koli Adedi	Fiyat
115375	LED	12	6500	1200	100	281x86	18	10	28,60\$
115376	LED	18	6500	1200	100	281x86	18	10	28,60\$
115377	LED Sensörlü	18	6500	1800	100	281x86	18	10	39,90\$
115378	LED+Sens.+Acil Ayd.	18	6500	1800	100	281x86	18	10	60,30\$

Özellikler Metal Opal Cam 4000 / 6500K IP40 50.000h

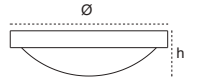

Sense (2xE27)

Kod	Tip	Güç (W)	Renk Sıcaklığı (K)	Işık Akısı (lm)	Etkinlik Faktörü (lm/W)	Boyutlar (mm)Øxh	Koli Ağırlığı (kg)	Koli Adedi	Fiyat
110695	2xE27	-	-	-	-	300x105	13	8	7,80\$
110917	2xE27 Sensörlü	-	-	-	-	300x105	13	8	17,10\$
110697	2xE27 Sensörlü+Acil Ayd.	-	-	-	-	300x105	13	8	19,40\$

Özellikler Metal Cam 6500K IP20 50.000h

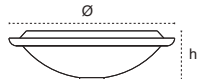

Sense LED

Kod	Tip	Güç (W)	Renk Sıcaklığı (K)	Işık Akısı (lm)	Etkinlik Faktörü (lm/W)	Boyutlar (mm)Øxh	Koli Ağırlığı (kg)	Koli Adedi	Fiyat
110696	Sensörlü	8	6500	864	108	300x105	13	8	16,60\$
104369	Sensörlü + Acil Ayd.	8	6500	864	108	300x105	13	8	27,40\$

Özellikler Metal Cam 6500K IP20 50.000h

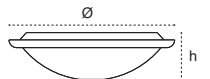

Pio

Kod	Güç (W)	Renk Sıcaklığı (K)	Işık Akısı (lm)	Etkinlik Faktörü (lm/W)	Boyutlar (mm)Øxh	Koli Ağırlığı (kg)	Koli Adedi	Fiyat
206688	12	4000	840	70	258x57	5,58	10	9,60\$
206677	12	6500	840	70	258x57	5,58	10	9,60\$
206037	18	4000	1260	70	335x60	7,49	10	11,00\$
206913	18	6500	1260	70	335x60	7,49	10	11,00\$
208411	28	4000	1960	70	387x58	13,8	10	13,80\$
208412	28	6500	1960	70	387x58	13,8	10	13,80\$

Özellikler Metal Opal Difüzör 4000 / 6500K IP40 30.000h

Opsiyonlar Radar Sensör

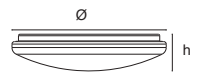

Tira S

Tira S Siyah

Tira IP54 / IP65

Tira S Sıva Üstü

Her Mekana Uygun Bir Tira Armatür Mutlaka Vardır!



3 Farklı Boy



Yeni Ürün



Rita G2 10W

Sıva Altı

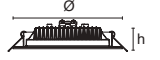

Kod	Güç (W)	Renk Sıcaklığı (K)	Işık Akısı (lm)	Etkinlik Faktörü (lm/W)	Boyutlar (mm)Øxh	Kesim Ölçüsü (mm)	Koli Ağırlığı (kg)	Koli Adedi	Fiyat
116197	10	4000	1100	110	145x30	120	9	30	21,25\$

Özellikler	Alüminyum	Opal Difüzör	3000/4000/6500K	IP40	50.000h	2 Yıl
Opsiyonlar	DALI	1-10V	Acil Aydınlatma (1-3 saat)			

Yeni Ürün



Rita G2 20W

Sıva Altı

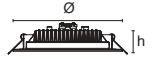

Kod	Güç (W)	Renk Sıcaklığı (K)	Işık Akısı (lm)	Etkinlik Faktörü (lm/W)	Boyutlar (mm)Øxh	Kesim Ölçüsü (mm)	Koli Ağırlığı (kg)	Koli Adedi	Fiyat
116200	20	4000	2200	110	145x30	120	9	30	25,00\$

Özellikler	Alüminyum	Opal Difüzör	3000/4000/6500K	IP40	50.000h	2 Yıl
Opsiyonlar	DALI	1-10V	Acil Aydınlatma (1-3 saat)			

Yeni Ürün



Rita G2 10W

Sıva Üstü

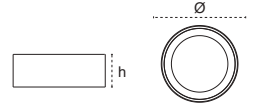

Kod	Güç (W)	Renk Sıcaklığı (K)	Işık Akısı (lm)	Etkinlik Faktörü (lm/W)	Boyutlar (mm)Øxh	Koli Ağırlığı (kg)	Koli Adedi	Fiyat
116254	10	4000	1100	110	150x90	11	20	29,50\$

Özellikler	Alüminyum	Opal Difüzör	3000/4000/6500K	IP40	50.000h	2 Yıl
Opsiyonlar	DALI	Acil Aydınlatma (1-3 saat)				

Yeni Ürün



Rita G2 20W

Sıva Üstü

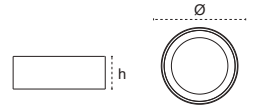

Kod	Güç (W)	Renk Sıcaklığı (K)	Işık Akısı (lm)	Etkinlik Faktörü (lm/W)	Boyutlar (mm)Øxh	Koli Ağırlığı (kg)	Koli Adedi	Fiyat
116251	20	4000	2200	110	150x90	11	20	33,50\$

Özellikler	Alüminyum	Opal Difüzör	3000/4000/6500K	IP40	50.000h	2 Yıl
Opsiyonlar	DALI	Acil Aydınlatma (1-3 saat)				

Kod	Özellikler	Koli Adedi	Fiyat
327764	Downlight Acil Aydınlatma Kiti (1saat)	1	27,60 \$
327251	Downlight Acil Aydınlatma Kiti (3saat)	1	31,60 \$
	DALI Dim Farkı	1	31,25 \$





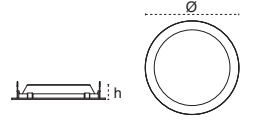

Yeni Ürün

**Tira S 10W**

Sıva Altı



Kod	Güç (W)	Renk Sıcaklığı (K)	Işık Akısı (lm)	Etkinlik Faktörü (lm/W)	Boyutlar (mm)Øxh	Kesim Ölçüsü (mm)	Koli Ağırlığı (kg)	Koli Adedi	Fiyat
210164	10	4000	1000	100	110x41	100	12,6	60	30,30\$

Özellikler	 Alüminyum	 Opal Difüzör	 3000/4000/6500K	 IP40	 50.000h	 5 Yıl
Opsiyonlar	 DALI	 1-10V	 Acil Aydınlatma (1-3 saat)	 RAL 9005		

Yeni Ürün

**Tira S 15W/20W**

Sıva Altı

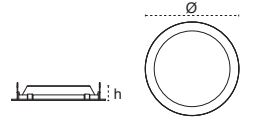

Kod	Güç (W)	Renk Sıcaklığı (K)	Işık Akısı (lm)	Etkinlik Faktörü (lm/W)	Boyutlar (mm)Øxh	Kesim Ölçüsü (mm)	Koli Ağırlığı (kg)	Koli Adedi	Fiyat
210168	15	4000	1860	124	175x41	165	12,4	24	34,70\$
210170	20	4000	2440	122	175x41	165	12,4	24	39,90\$

Özellikler	 Alüminyum	 Opal Difüzör	 3000/4000/6500K	 IP40	 50.000h	 5 Yıl
Opsiyonlar	 DALI	 1-10V	 Acil Aydınlatma (1-3 saat)	 RAL 9005		



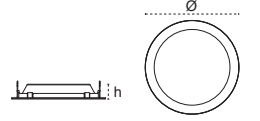

Yeni Ürün

**Tira S 20W/35W**

Sıva Altı



Kod	Güç (W)	Renk Sıcaklığı (K)	Işık Akısı (lm)	Etkinlik Faktörü (lm/W)	Boyutlar (mm)Øxh	Kesim Ölçüsü (mm)	Koli Ağırlığı (kg)	Koli Adedi	Fiyat
210172	20	4000	2460	123	225x41	215	13,3	24	48,65\$
210174	25	4000	3050	122	225x41	215	13,3	18	57,90\$
210176	35	4000	4235	121	225x41	215	13,3	18	67,10\$

Özellikler	 Alüminyum	 Opal Difüzör	 3000/4000/6500K	 IP40	 50.000h	 5 Yıl
Opsiyonlar	 DALI	 1-10V	 Acil Aydınlatma (1-3 saat)	 RAL 9005		



Yeni Ürün

**Tira S IP54/IP65**

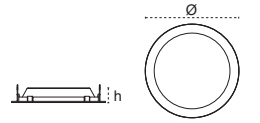
Sıva Altı



Kod	Güç (W)	Renk Sıcaklığı (K)	Işık Akısı (lm)	Etkinlik Faktörü (lm/W)	Boyutlar (mm)Øxh	Kesim Ölçüsü (mm)	Koli Ağırlığı (kg)	Koli Adedi	Fiyat
210185	10	4000	1000	100	110x41	100	12,6	60	36,30\$
210189	15	4000	1860	124	175x41	165	12,4	24	45,30\$
210191	20	4000	2440	122	175x41	165	12,4	24	46,70\$
210199	20	4000	2460	123	225x41	215	13,3	24	62,10\$
210201	25	4000	3050	122	225x41	215	13,3	18	65,10\$
210203	35	4000	4235	121	225x41	215	13,3	18	73,75\$

Özellikler	 Alüminyum	 Opal Difüzör	 3000/4000/6500K	 IP54 / IP65	 50.000h	 5 Yıl
Opsiyonlar	 DALI	 1-10V	 Acil Aydınlatma (1-3 saat)	 RAL 9005		

5
YIL
GARANTİ

Dore

7W

10W-13W

18W-22W



TSE Belgesi



Slim
Tasarım



134 lm/W'a
Varan Verimlilik



ENEC Belgesi
Sürücü



+50.000h
LED Ömrü



Dore 7W

Sıva Altı

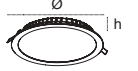

Kod	Güç (W)	Renk Sıcaklığı (K)	Işık Akısı (lm)	Etkinlik Faktörü (lm/W)	Boyutlar (mm)Øxh	Kesim Ölçüsü (mm)	Koli Ağırlığı (kg)	Koli Adedi	Fiyat
110864	7	4000	791	113	120x45	105	6	30	13,25\$

Özellikler	Opsiyonlar
<ul style="list-style-type: none"> ABS-PC Opal Difüzör 3000/4000/6500K IP40 50.000h 5 Yıl 	<ul style="list-style-type: none"> DALI 1-10V Acil Aydınlatma (1-3 saat)



Dore 10W/13W

Sıva Altı

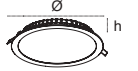

Kod	Güç (W)	Renk Sıcaklığı (K)	Işık Akısı (lm)	Etkinlik Faktörü (lm/W)	Boyutlar (mm)Øxh	Kesim Ölçüsü (mm)	Koli Ağırlığı (kg)	Koli Adedi	Fiyat
110865	10	4000	1120	112	170x45	155	10	30	16,60\$
110866	13	4000	1547	119	170x45	155	10	30	18,95\$

Özellikler	Opsiyonlar
<ul style="list-style-type: none"> ABS-PC Opal Difüzör 3000/4000/6500K IP40 50.000h 5 Yıl 	<ul style="list-style-type: none"> DALI 1-10V Acil Aydınlatma (1-3 saat)



Dore 18W/22W

Sıva Altı

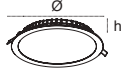

Kod	Güç (W)	Renk Sıcaklığı (K)	Işık Akısı (lm)	Etkinlik Faktörü (lm/W)	Boyutlar (mm)Øxh	Kesim Ölçüsü (mm)	Koli Ağırlığı (kg)	Koli Adedi	Fiyat
110867	18	4000	2412	134	225x45	205	11,4	20	24,90\$
110868	22	4000	2948	134	225x45	205	11,4	20	26,15\$

Özellikler	Opsiyonlar
<ul style="list-style-type: none"> ABS-PC Opal Difüzör 3000/4000/6500K IP40 50.000h 5 Yıl 	<ul style="list-style-type: none"> DALI 1-10V Acil Aydınlatma (1-3 saat)



Dore 18W/22W

Sıva Üstü

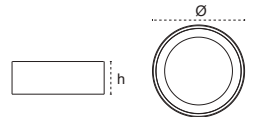

Kod	Güç (W)	Renk Sıcaklığı (K)	Işık Akısı (lm)	Etkinlik Faktörü (lm/W)	Boyutlar (mm)Øxh	Koli Ağırlığı (kg)	Koli Adedi	Fiyat
111752	18	4000	2412	134	228x55	7,2	10	29,65\$
111755	22	4000	2420	110	228x55	7,2	10	31,70\$

Özellikler	Opsiyonlar
<ul style="list-style-type: none"> ABS-PC Opal Difüzör 3000/4000/6500K IP40 50.000h 5 Yıl 	<ul style="list-style-type: none"> DALI 1-10V Acil Aydınlatma (1-3 saat)

Kod	Özellikler	Koli Adedi	Fiyat
327764	Acil Aydınlatma Kiti (1 saat)	1	27,60\$
327251	Acil Aydınlatma Kiti (3 saat)	1	31,60\$



Sirma

x2.09 kat
daha fazla ışık çıktısıBirebir
Değişim Garantisi

6W/9W



12W/15W



18W

*Sirma backlight, sıradan slim downlight armatürlere göre 2,09 kat daha fazla ışık çıktısı sunar.

Slim
TasarımBacklight
Işık KonforuDahili
SürücüAcil Kit
Uygulaması

Sirma 6W/9W

Sıva Altı

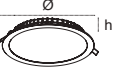

Kod	Güç (W)	Renk Sıcaklığı (K)	Işık Akısı (lm)	Etkinlik Faktörü (lm/W)	Boyutlar (mm)Øxh	Kesim Ölçüsü (mm)	Koli Ağırlığı (kg)	Koli Adedi	Fiyat
110330	6	3000	528	88	120x45	105	2,5	20	4,85\$
110331	6	4000	528	88	120x45	105	2,5	20	4,85\$
110332	6	6500	528	88	120x45	105	2,5	20	4,85\$
110333	9	3000	783	87	120x45	105	2,5	20	6,35\$
110334	9	4000	783	87	120x45	105	2,5	20	6,35\$
110335	9	6500	783	87	120x45	105	2,5	20	6,35\$

Özellikler: ABS-PC, Opal Difüzör, 3000/4000/6500K, IP40, 30.000h

Opsiyonlar: Acil Aydınlatma (1-3 saat)



Sirma 12W/15W

Sıva Altı

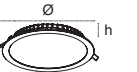

Kod	Güç (W)	Renk Sıcaklığı (K)	Işık Akısı (lm)	Etkinlik Faktörü (lm/W)	Boyutlar (mm)Øxh	Kesim Ölçüsü (mm)	Koli Ağırlığı (kg)	Koli Adedi	Fiyat
110339	12	3000	1092	91	170x45	155	3,1	15	7,55\$
110340	12	4000	1092	91	170x45	155	3,1	15	7,55\$
110341	12	6500	1092	91	170x45	155	3,1	15	7,55\$
110342	15	3000	1350	90	170x45	155	3,1	15	9,40\$
110343	15	4000	1350	90	170x45	155	3,1	15	9,40\$
110344	15	6500	1350	90	170x45	155	3,1	15	9,40\$

Özellikler: ABS-PC, Opal Difüzör, 3000/4000/6500K, IP40, 30.000h

Opsiyonlar: Acil Aydınlatma (1-3 saat)



Sirma 18W

Sıva Altı

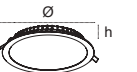

Kod	Güç (W)	Renk Sıcaklığı (K)	Işık Akısı (lm)	Etkinlik Faktörü (lm/W)	Boyutlar (mm)Øxh	Kesim Ölçüsü (mm)	Koli Ağırlığı (kg)	Koli Adedi	Fiyat
110348	18	3000	1782	99	225x45	205	3,7	10	10,80\$
110349	18	4000	1782	99	225x45	205	3,7	10	10,80\$
110350	18	6500	1782	99	225x45	205	3,7	10	10,80\$

Özellikler: ABS-PC, Opal Difüzör, 3000/4000/6500K, IP40, 30.000h

Opsiyonlar: Acil Aydınlatma (1-3 saat)



Sirma

Sıva Üstü

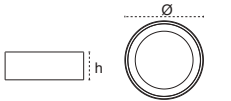

Kod	Güç (W)	Renk Sıcaklığı (K)	Işık Akısı (lm)	Etkinlik Faktörü (lm/W)	Boyutlar (mm)Øxh	Koli Ağırlığı (kg)	Koli Adedi	Fiyat
111748	18	3000	1782	99	228x55	5,2	10	15,30\$
111749	18	4000	1782	99	228x55	5,2	10	15,30\$
111750	18	6500	1782	99	228x55	5,2	10	15,30\$

Özellikler: ABS-PC, Opal Difüzör, 3000/4000/6500K, IP40, 30.000h

Kod	Özellikler	Koli Adedi	Fiyat
313117	Acil Aydınlatma Kiti (1 saat)	1	27,60\$



**Yeni
Havana**



**Vidasız Çerçeve ile
Mükemmel Görünüm**



Daha Kolay Montaj



Kitli + Radar Sensörlü



IP66 Su ve Toz Almaz!

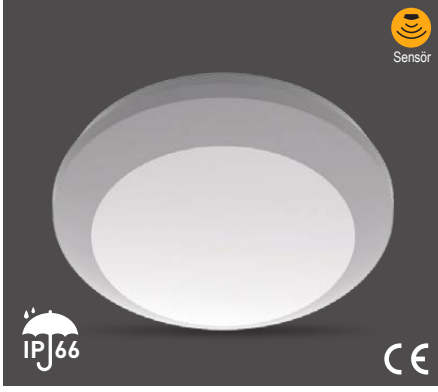

Havana G2 - E27 Duylu

Kod	Tip	Güç (W)	Renk Sıcaklığı (K)	Işık Akısı (lm)	Etkinlik faktörü (lm/W)	Boyutlar (mm)Øxh	Koli Ağırlığı (kg)	Koli Adedi	Fiyat
111193	1xE27	max.20	-	-	-	260x87	5,8	8	18,70\$
111194	2xE27	max.20	-	-	-	260x87	5,8	8	19,90\$
111220	1xE27+Sensor	max.20	-	-	-	260x87	5,8	8	35,00\$
111223	2xE27+Sensor	max.20	-	-	-	260x87	5,8	8	36,30\$

Özellikler	Polimer Enjeksiyon	Opal Difüzör	3000/4000/6500K	IP66	50.000h
Opsiyonlar	Radar Sensör	RAL 9010			

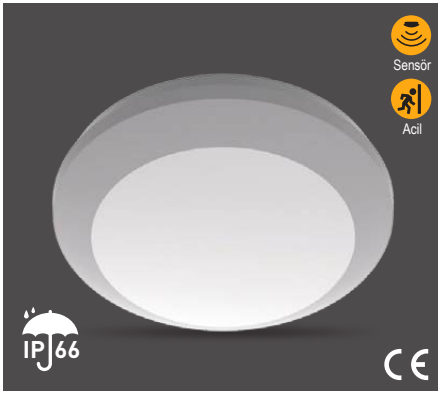
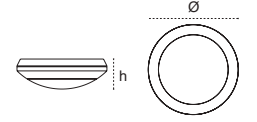

Havana G2 - LED - ENEC Driver

Kod	Tip	Güç (W)	Renk Sıcaklığı (K)	Işık Akısı (lm)	Etkinlik faktörü (lm/W)	Boyutlar (mm)Øxh	Koli Ağırlığı (kg)	Koli Adedi	Fiyat
111226	LED	15	6500	1605	107	260x87	5,8	8	34,00\$
111236	LED + Sensör	15	6500	1605	107	260x87	5,8	8	50,60\$
111245	LED + Acil Ayd. Kitli	15	6500	1605	107	260x87	5,8	8	61,60\$
111260	LED + Acil Ayd. Kitli + Sensör	15	6500	1605	107	260x87	5,8	8	78,85\$

Özellikler	Polimer Enjeksiyon	Opal Difüzör	3000/4000/6500K	IP66	50.000h
Opsiyonlar	DALI	1-10V	Acil Aydınlatma (1-3 saat)	Radar Sensör	

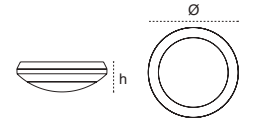

Havana G2 - LED - Integrated Driver

Kod	Tip	Güç (W)	Renk Sıcaklığı (K)	Işık Akısı (lm)	Etkinlik faktörü (lm/W)	Boyutlar (mm)Øxh	Koli Ağırlığı (kg)	Koli Adedi	Fiyat
111692	Integrated Driver	18	6500	1530	85	260x87	5,8	8	27,05\$
111701	Integrated Driver + Sensör	18	6500	1530	85	260x87	5,8	8	43,60\$

Özellikler	Polimer Enjeksiyon	Opal Difüzör	3000/4000/6500K	IP66	30.000h
Opsiyonlar	Radar Sensör				

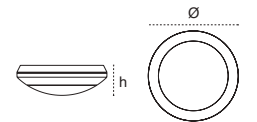



360° Hareket Sensörü

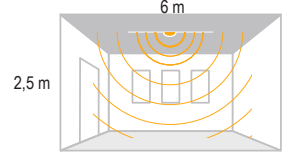

Kod	Algılama Mesafesi (m)	Montaj Yüksekliği (m)	Boyutlar (mm)Øxh	Koli Ağırlığı (kg)	Koli Adedi	Fiyat
314720	6	2,2-4	80x41	6,2	50	9,95\$

Özellikler  Polimer Enjeksiyon  IP20  Zaman Ayarı  Lux Ayarı  Sun Modu  Moon Modu



Varlık Sensörü

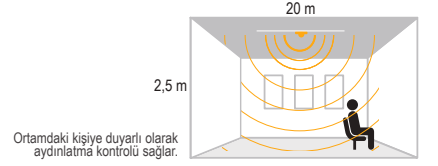

Kod	Algılama Mesafesi (m)	Montaj Yüksekliği (m)	Boyutlar (mm)Øxh	Koli Ağırlığı (kg)	Koli Adedi	Fiyat
314733	20	2,2-6	102,5x58,3	10	50	25,50\$

Özellikler  Polimer Enjeksiyon  IP20  Zaman Ayarı  Lux Ayarı  Sun Modu  Moon Modu



Radar Sensörü

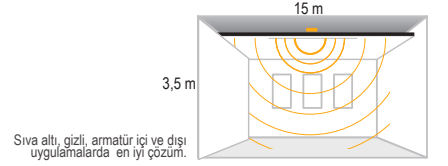

Kod	Tip	Algılama Mesafesi (m)	Montaj Yüksekliği (m)	Boyutlar (mm)axb	Koli Ağırlığı (kg)	Koli Adedi	Fiyat
314735	IP65 Sensör Kutusu	-	-	134x65,5	-	50	11,10\$
314725	Radar Sensör	15	3,5	93x47x44	9,8	100	15,70\$

Özellikler  Polimer Enjeksiyon  IP20  Zaman Ayarı  Lux Ayarı  Hassasiyet Ayarı  Sun Modu  Moon Modu



Sıva Altı Radar Sensörü

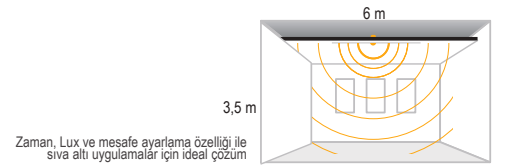

Kod	Algılama Mesafesi (m)	Montaj Yüksekliği (m)	Boyutlar (mm)Øxh	Kesim Ölçüsü (mm)	Koli Ağırlığı (kg)	Koli Adedi	Fiyat
326838	6	2,2-4	76x74,4	66	7,5	50	15,75\$





Özellikler  Polimer Enjeksiyon  IP20  Zaman Ayarı  Lux Ayarı  Hassasiyet Ayarı  Sun Modu  Moon Modu

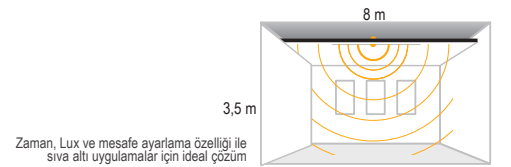

Sıva Üstü Radar Sensörü



Kod	Algılama Mesafesi (m)	Montaj Yüksekliği (m)	Boyutlar (mm)Øxh	Koli Ağırlığı (kg)	Koli Adedi	Fiyat
326839	8	2-6	114x22	8,06	50	15,75\$

Özellikler  Polimer Enjeksiyon  IP20  Zaman Ayarı  Lux Ayarı  Hassasiyet Ayarı  Sun Modu  Moon Modu



Sıva Altı Tavan Sensörü

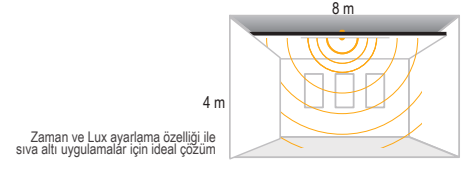

Zaman ve Lux ayarlama özelliği ile sıva altı uygulamalar için ideal çözüm

Kod	Algılama Mesafesi (m)	Montaj Yüksekliği (m)	Boyutlar (mm)axbxc	Kesim Ölçüsü (mm)	Koli Ağırlığı (kg)	Koli Adedi	Fiyat
314726	8	3,5	50x66,5x40	65	7	50	11,55\$

Özellikler Polimer Enjeksiyon IP20 Zaman Ayan Lux Ayan Sun Modu Moon Modu

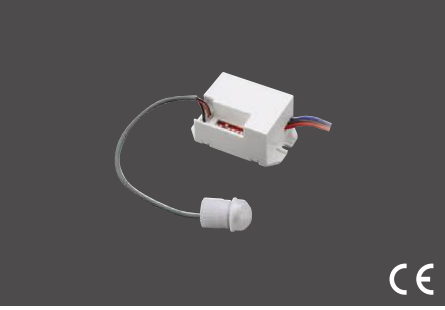

Mini Hareket Sensörü

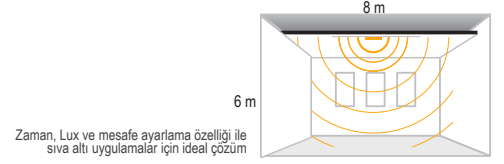

Zaman, Lux ve mesafe ayarlama özelliği ile sıva altı uygulamalar için ideal çözüm

Kod	Algılama Mesafesi (m)	Montaj Yüksekliği (m)	Boyutlar (mm)axbxc	Kesim Ölçüsü (mm)	Koli Ağırlığı (kg)	Koli Adedi	Fiyat
314732	6	2,5	55,4x25,5x36,83	13	-	100	10,20\$

Özellikler Polimer Enjeksiyon IP20 Zaman Ayan Lux Ayan Sun Modu Moon Modu



Yüksek Tavan Sensörü

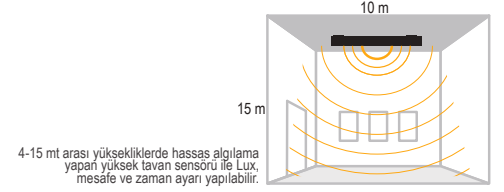

4-15 mt arası yüksekliklerde hassas algılama yapan yüksek tavan sensörü ile Lux, mesafe ve zaman ayarı yapılabilir.

Kod	Algılama Mesafesi (m)	Montaj Yüksekliği (m)	Boyutlar (mm)axbxc	Koli Ağırlığı (kg)	Koli Adedi	Fiyat
314730	10	15	74x32,5x74	6,9	50	35,90\$

Özellikler Polimer Enjeksiyon IP20 Zaman Ayan Lux Ayan Hassasiyet Ayan Sun Modu Moon Modu



180° Hareket Sensörü

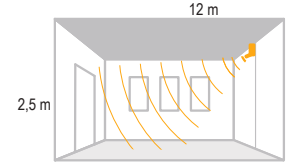

Kod	Algılama Mesafesi (m)	Montaj Yüksekliği (m)	Boyutlar (mm)axbxc	Koli Ağırlığı (kg)	Koli Adedi	Fiyat
314717	12	2,5-4	135x120x66	12,5	50	9,50\$

Özellikler Polimer Enjeksiyon IP20 Zaman Ayan Lux Ayan Sun Modu Moon Modu



Fotosel

Gece gündüz farkını algılayarak dış mekan aydınlatmalarında kontrol sağlar.

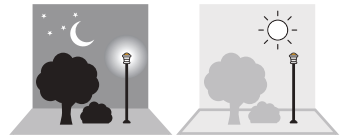

Kod	Algılama Mesafesi (m)	Montaj Yüksekliği (m)	Boyutlar (mm)axbxc	Koli Ağırlığı (kg)	Koli Adedi	Fiyat
314738	-	-	63x77	13,6	100	6,15\$

Özellikler Polimer Enjeksiyon IP44





Acil Aydınlatma ve Yönlendirme Armatürleri

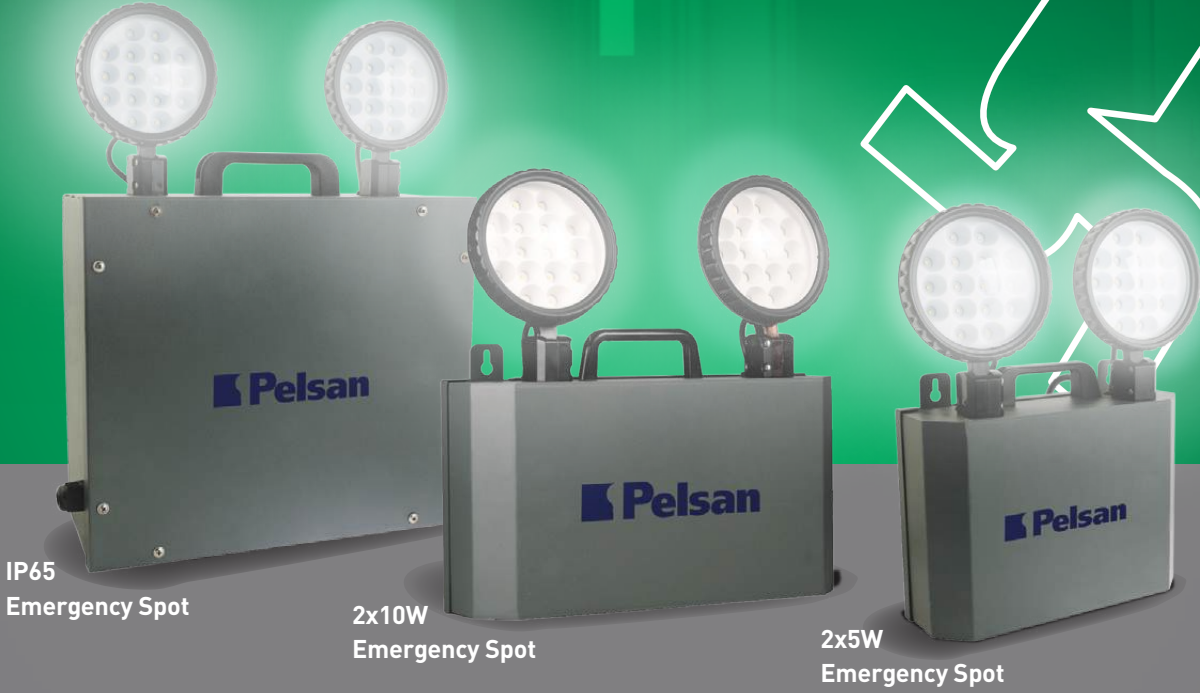

IP65
Emergency Spot

2x10W
Emergency Spot

2x5W
Emergency Spot



Oynar Başlık



Anahtarlı, Test Butonlu



Şarj, Deşarj Göstergeli



6 Saat Deşarj Süresi



Taşınabilir, Asılabilir



IP40 / IP65 Opsiyonel



- Oynar Başlık
- Anahtarlı, Test Butonlu
- Şarj, Deşarj Göstergeli
- 6 Saat Deşarj Süresi
- Taşınabilir, Asılabilir



2x10W



IP65 Metal Gövde Emergency Spot

Kod	Güç (W)	Batarya	Şarj Süresi	Deşarj Süresi	Renk Sıcaklığı (K)	Boyutlar (mm)axbxc	Koli Ağırlığı (kg)	Koli Adedi	Fiyat
110679	2x10	6 V 4500 mAh	30h	6h	4000	340x480x150	6,7	1	178,10\$

Özellikler

- Metal
- PMMA Difüzör
- 4000/6500K
- IP65
- LED Çip Ömrü 50.000h
- Şarj Göstergesi
- Deşarj Göstergesi
- Anahtar ve Test Butonu
- Taşınabilir, Asılabilir

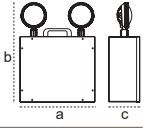

2x5W

2x10W



Metal Gövde Emergency Spot

Kod	Güç (W)	Batarya	Şarj Süresi	Deşarj Süresi	Renk Sıcaklığı (K)	Boyutlar (mm)axbxc	Koli Ağırlığı (kg)	Koli Adedi	Fiyat
109781	2x5	6 V 4500 mAh	30h	6h	4000	275x340x80	10,8	4	80,40\$
109780	2x10	6 V 4500 mAh	30h	6h	4000	325x340x80	12	4	139,50\$

Özellikler

- Metal
- PMMA Difüzör
- 4000/6500K
- IP40
- LED Çip Ömrü 50.000h
- Şarj Göstergesi
- Deşarj Göstergesi
- Anahtar ve Test Butonu
- Taşınabilir, Asılabilir

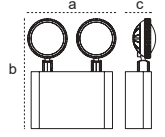

2x5W

2x10W



Emergency Spot

Kod	Güç (W)	Batarya	Şarj Süresi	Deşarj Süresi	Renk Sıcaklığı (K)	Boyutlar (mm)axbxc	Koli Ağırlığı (kg)	Koli Adedi	Fiyat
203913	2x5	4 V 2000 mAh	24h	2h	4000	280x279x89	9,5	8	71,40\$
203907	2x10	6 V 3000 mAh	24h	6h	4000	286x299x89	12,7	8	114,80\$

Özellikler

- Polimer Enjeksiyon
- PMMA Difüzör
- 4000K
- IP40
- LED Çip Ömrü 50.000h
- Şarj Göstergesi
- Deşarj Göstergesi
- Anahtar Butonu
- Taşınabilir, Asılabilir

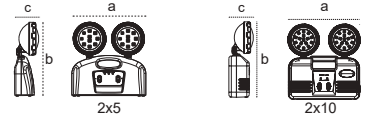

2x3W



Emergency Spot

Kod	Güç (W)	Batarya	Şarj Süresi	Deşarj Süresi	Renk Sıcaklığı (K)	Boyutlar (mm)axbxc	Koli Ağırlığı (kg)	Koli Adedi	Fiyat
203911	2x3	4 V 2000 mAh	24h	6h	4000	261x89x59	6,4	10	46,20\$

Özellikler

- Plastik
- PMMA Difüzör
- 4000K
- IP40
- LED Çip Ömrü 50.000h
- Şarj Göstergesi
- Deşarj Göstergesi
- Anahtar ve Test Butonu
- Taşınabilir, Asılabilir

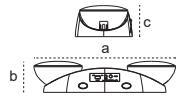



Vialed (3 saat)

Kod	Güç (W)	Batarya	Şarj Süresi	Deşarj Süresi	Renk Sıcaklığı (K)	Boyutlar (mm)axbxc	Koli Ağırlığı (kg)	Koli Adedi	Fiyat
200965	3	1000 mAh 1.2 Ni-Mh	24h	3h	6500	280x205x42	11	10	31,75\$
200981	3	1000 mAh 1.2 Ni-Mh	24h	3h	6500	280x205x42	11	10	31,75\$
200963	3	1000 mAh 1.2 Ni-Mh	24h	3h	6500	280x205x42	11	10	31,75\$



Özellikler  Alüminyum  PMMA Difüzör  IP20  50.000h  Şarj Göstergesi  Deşarj Göstergesi

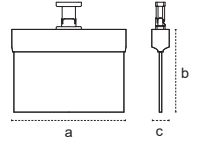

Vialed (3 saat)

Kod	Tip	Güç (W)	Batarya	Şarj Süresi	Deşarj Süresi	Renk Sıcaklığı (K)	Boyutlar (mm)axbxc	Koli Ağırlığı (kg)	Koli Adedi	Fiyat
200944	Tek Yön	3	1000 mAh 1.2 Ni-Mh	24h	3h	6500	280x205x42	11	10	31,75\$
201013	Çift Yön	3	1000 mAh 1.2 Ni-Mh	24h	3h	6500	280x205x42	11	10	31,75\$
205265	Çift Yön	3	1000 mAh 1.2 Ni-Mh	24h	3h	6500	280x205x42	11	10	31,75\$
200946	Tek Yön	3	1000 mAh 1.2 Ni-Mh	24h	3h	6500	280x205x42	11	10	31,75\$



Özellikler  Alüminyum  PMMA Difüzör  IP20  50.000h  Şarj Göstergesi  Deşarj Göstergesi

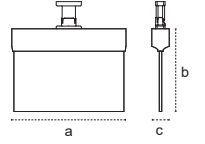

Exiled (3 saat)

Kod	Tip	Güç (W)	Batarya	Şarj Süresi	Deşarj Süresi	Renk Sıcaklığı (K)	Boyutlar (mm)axbxc	Koli Ağırlığı (kg)	Koli Adedi	Fiyat
203885	Çift Yön	3	800 mAh 1.2 Ni-Cd	24h	3h	6500	360x150x24	6,8	20	11,40\$
203891	Tek Yön	3	800 mAh 1.2 Ni-Cd	24h	3h	6500	360x150x24	6,8	20	11,40\$
203888	Çift Yön	3	800 mAh 1.2 Ni-Cd	24h	3h	6500	360x150x24	6,8	20	11,40\$
203889	Çift Yön	3	800 mAh 1.2 Ni-Cd	24h	3h	6500	360x150x24	6,8	20	11,40\$



Özellikler  Alüminyum  Seyrek Cam  IP20  30.000h  Şarj Göstergesi  Deşarj Göstergesi  Test Butonu

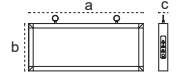

Exiled (3 saat)

Kod	Tip	Güç (W)	Batarya	Şarj Süresi	Deşarj Süresi	Renk Sıcaklığı (K)	Boyutlar (mm)axbxc	Koli Ağırlığı (kg)	Koli Adedi	Fiyat
203887	Çift Yön	3	800 mAh 1.2 Ni-Cd	24h	3h	6500	360x150x24	6,8	20	11,40\$
203890	Çift Yön	3	800 mAh 1.2 Ni-Cd	24h	3h	6500	360x150x24	6,8	20	11,40\$
205688	Çift Yön	3	800 mAh 1.2 Ni-Cd	24h	3h	6500	450x188x94	11	20	11,40\$



Özellikler  Alüminyum  Seyrek Cam  IP20  30.000h  Şarj Göstergesi  Deşarj Göstergesi  Test Butonu

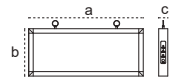

4 Farklı Yön Etiket

Rausled (3 saat) IP65

Kod	Tip	Güç (W)	Batarya	Şarj Süresi	Deşarj Süresi	Işık Akısı (lm)	Renk Sıcaklığı (K)	Elknlük Faktörü (lm/W)	Boyutlar (mm)axbxc	Koli Ağırlığı (kg)	Koli Adedi	Fiyat
113621	Sıva Üstü	5	3,7V 3500mAh	24h	3h	500	6500	100	350x117x218	5,5	6	61,00\$



Özellikler  Polimer Enjeksiyon  PC Difüzör  3000/4000/6500K  IP65  50.000h

Opsiyonlar  DALI

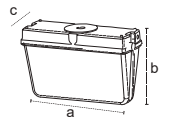

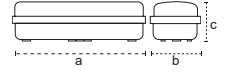

Ausled (3 saat)



Kod	Tip	Güç (W)	Batarya	Şarj Süresi	Deşarj Süresi	Işık Akısı (lm)	Renk Sıcaklığı (K)	Etkinlik Faktörü (lm/W)	Boyutlar (mm)axbxc	Koli Ağırlığı (kg)	Koli Adedi	Fiyat
115138	AC	10	-	24h	3h	1000	6500	100	350x117x76	10,4	12	25,50\$
115140	DC	3	3,7V 3500mAh	24h	3h	300	6500	100	350x117x76	10,4	12	45,70\$
108390	AC/DC	5	3,7V 3500mAh	24h	3h	500	6500	100	350x117x76	10,4	12	49,00\$
110667	AC/DC	10	3,7V 3500mAh	24h	3h	1000	6500	100	350x117x76	10,4	12	53,00\$



Özellikler

- Polimer Enjeksiyon
- PC Difüzör
- 3000/4000/6500K
- IP65
- 50.000h

Opsiyonlar

- DALI

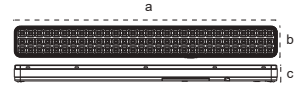

Işıldaklar



Kod	Tip	Batarya	Şarj Süresi	Deşarj Süresi	Renk Sıcaklığı (K)	Boyutlar (mm)axbxc	Koli Ağırlığı (kg)	Koli Adedi	Fiyat
204619	30 LED	3,7V 1,2Ah Ni-Cd	24h	8h	6500	203x55x29	7,5	40	9,50\$
204620	60 LED	3,7V 2,2Ah Ni-Cd	24h	8h	6500	342x55x29	7,5	24	16,40\$
204623	90 LED	2x3,7V 2,0Ah Ni-Cd	24h	8h	6500	482x55x29	7,5	20	26,60\$
209039	120 LED	2x3,7V 2,2Ah Ni-Cd	24h	8h	6500	482x55x29	7,5	20	35,65\$



Özellikler

- Polimer Enjeksiyon
- Plastik Difüzör
- 6500K
- IP40
- 30.000h

- Şarj Göstergesi
- Deşarj Göstergesi
- Anahtar ve Test Butonu
- Taşınabilir, Asılabilir



Solar



220Vac



Solar Işıldak

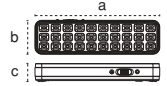

Kod	Tip	Batarya	Şarj Süresi	Deşarj Süresi	Renk Sıcaklığı (K)	Boyutlar (mm)axbxc	Koli Ağırlığı (kg)	Koli Adedi	Fiyat
206489	30 LED	4 V 2000 mAh	24h	8h	6500	140x64x46	4	20	15,10\$



Özellikler

- Polimer Enjeksiyon
- Plastik Difüzör
- 6500K
- IP20
- 30.000h

- Şarj Göstergesi
- Deşarj Göstergesi
- Anahtar ve Test Butonu
- Taşınabilir, Asılabilir

Acil Aydınlatma Kiti



Kod	Tip	Çıkış Gerilimi (K)	Şarj Süresi	Çalışma Süresi	Boyutlar (mm)axbxc	Koli Ağırlığı (kg)	Koli Adedi	Fiyat
327251	LED Modül Kiti 3H	12-110 DC	24h	3 saat 36W için	40x148x27	5,5	50	31,60\$
327764	LED Modül Kiti 1H	12-110 DC	24h	1 saat 36W için	40x148x27	5,5	50	27,60\$

Özellikler

- Plastik
- Li-ion

220Vac Acil Aydınlatma Kiti



Kod	Çıkış Gerilimi (K)	Batarya	Şarj Süresi	Deşarj Süresi	Boyutlar (mm)axbxc	Koli Ağırlığı (kg)	Koli Adedi	Fiyat
313117	12-250Vac	3,7V 4500mAh	24h	1h	230x39x30	9	25	27,60\$

Özellikler

- Plastik
- Li-ion

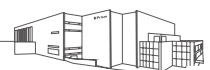

Kolay ve Hızlı Linear Bağlantı

T5 floresan armatürlere göre
%60 'a varan tasarruf,
2,5 kat daha uzun ömür

Monoline
Linear Market Armatürü





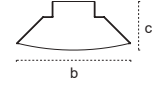



Monoline Linear Market Armatürü



Kod	Güç (W)	Renk Sıcaklığı (K)	Işık Akısı (lm)	Etkinlik Faktörü (lm/W)	Boyutlar (mm)axbxc	Koli Ağırlığı (kg)	Koli Adedi	Fiyat
109564	28	6500	3360	120	1133x169x72	18	6	78,30\$
109566	35	6500	4200	120	1415x169x72	18	4	87,30\$



Özellikler	 Metal	 Opal Diffüzör	 3000/4000/6500K	 IP40	 50.000h
Opsiyonlar	 DALI	 1-10V	 Acil Aydınlatma (1-3 saat)	 Sarkit	



Linea IP65 Bant Armatürü

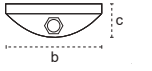

Kod	Güç (W)	Renk Sıcaklığı (K)	Işık Akısı (lm)	Etkinlik Faktörü (lm/W)	Boyutlar (mm)axbxc	Koli Ağırlığı (kg)	Koli Adedi	Fiyat
113654	36	6500	3600	100	1133x75x25	7,8	20	17,90\$



Özellikler	 PC	 Opal Diffüzör	 4000/6500K	 IP65	 30.000h
-------------------	--	---	--	---	---



Linea IP40 Bant Armatürü

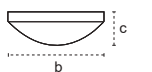

Kod	Güç (W)	Renk Sıcaklığı (K)	Işık Akısı (lm)	Etkinlik Faktörü (lm/W)	Boyutlar (mm)axbxc	Koli Ağırlığı (kg)	Koli Adedi	Fiyat
113653	36	4000	3600	100	1155x75x25	7,8	20	11,70\$
113652	36	6500	3600	100	1155x75x25	7,8	20	11,70\$



Özellikler	 PC	 Opal Diffüzör	 4000/6500K	 IP40	 30.000h
-------------------	--	---	--	---	---

Largo G2
Etanj Armatür

Geniş Güç / Lümen Paketi
14-100W 1820-12400lm

140lm/W'a Varan Verimlilik
%61'e varan tasarruf

Sahada Bakım Kolaylığı
(Sürücü / Işık Kaynağı Kolay Değişir)

5yıl Garanti
Uzun Ömür, Yüksek Performans

Paslanmaz Metal
Mandal ve Montaj Aparatı



600mm

1200mm

1500mm

Yeni Ürün



Largo G2
Etanj

Kod	Güç (W)	Renk Sıcaklığı (K)	Işık Akısı (lm)	Etkinlik Faktörü (lm/W)	Boyutlar (mm)axbxc	Koli Ağırlığı (kg)	Koli Adedi	Fiyat
115957	14	6500	1820	130	610x80x75	7,8	6	28,40\$
115787	20	6500	2500	125	610x80x75	7,8	6	28,40\$
115963	27	6500	3159	117	610x80x75	7,8	6	30,90\$
116061	26	6500	3458	133	1150x80x75	14,7	6	33,90\$
116062	34	6500	4420	130	1150x80x75	14,7	6	33,90\$
116063	50	6500	6100	122	1150x80x75	14,7	6	62,25\$
116064	75	6500	8550	114	1150x80x75	14,7	6	80,40\$
116067	100	6500	11200	112	1500x80x75	19,1	6	93,50\$

Özellikler



PC



PC Difüzör



3000/4000/6500K



IP65



50.000h

Opsiyonlar



DALI



1-10V



Acil Aydınlatma (1-3 saat)



Radar Sensör



Busbar



Sarkıt





PC Gövde

Folta

PC Etanj

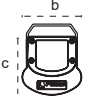

Kod	Güç (W)	Renk Sıcaklığı (K)	Işık Akısı (lm)	Etkinlik Faktörü (lm/W)	Boyutlar (mm)axbxc	Koli Ağırlığı (kg)	Koli Adedi	Fiyat
115838	18	6500	2142	119	555x64x46	6,5	12	28,60\$
115840	23	6500	2806	122	805x64x46	9	12	29,65\$
115842	33	6500	3993	121	1055x64x46	11	12	30,70\$
115011	43	6500	5160	120	1305x64x46	13,5	12	47,90\$



Özellikler	PC	Opal Difüzör	3000/4000/6500K	IP65	50.000h	5 Yıl
Opsiyonlar	DALI	1-10V	Acil Aydınlatma (1-3 saat)			



Alüminyum Gövde

Prota G3

Alüminyum Etanj

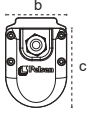

Kod	Güç (W)	Renk Sıcaklığı (K)	Işık Akısı (lm)	Etkinlik Faktörü (lm/W)	Boyutlar (mm)axbxc	Koli Ağırlığı (kg)	Koli Adedi	Fiyat
115830	18	6500	2250	125	555x64x46	7	12	32,70\$
115832	23	6500	2921	127	805x64x46	9,5	12	41,75\$
115834	33	6500	4125	125	1055x64x46	11,5	12	50,50\$
115020	43	6500	5504	128	1305x64x46	14	12	63,50\$



Özellikler	Alüminyum	Opal Difüzör	3000/4000/6500K	IP65	50.000h	5 Yıl
Opsiyonlar	DALI	1-10V	Acil Aydınlatma (1-3 saat)			

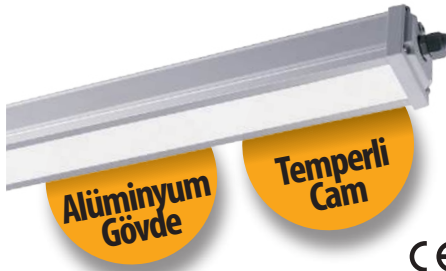

Alüminyum Gövde

Temperli Cam

Inovaled G2 IP66

Temperli Cam Alüminyum Etanj

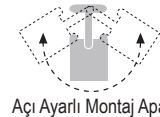

Açı Ayarlı Montaj Aparatı

Kod	Güç (W)	Renk Sıcaklığı (K)	Işık Akısı (lm)	Etkinlik Faktörü (lm/W)	Boyutlar (mm)axbxc	Koli Ağırlığı (kg)	Koli Adedi	Fiyat	
113454	19	6500	2033	107	630x72x59	8,6	6	61,50\$	
113457	26	6500	2782	107	910x72x59	10,7	6	94,55\$	
113460	34	6500	3672	108	1190x72x59	14,7	6	113,80\$	
326217	Açı ayarlı montaj aparatı (2'li)							1	3,50\$



Özellikler	Alüminyum	Temperli Cam	3000/4000/6500K	IP66	50.000h	5 Yıl
Opsiyonlar	DALI	1-10V	Acil Aydınlatma (1-3 saat)			



Otopark Fonksiyonu

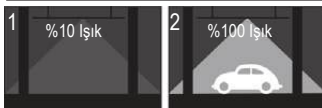

Largo

Otopark Fonksiyonlu Etanj

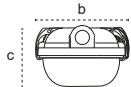

Kod	Güç (W)	Renk Sıcaklığı (K)	Işık Akısı (lm)	Etkinlik Faktörü (lm/W)	Boyutlar (mm)axbxc	Koli Ağırlığı (kg)	Koli Adedi	Fiyat
113489	36	6500	3960	110	1273x85x85	10	6	126,00\$



Özellikler	GRP	PC Difüzör	3000/4000/6500K	IP65	50.000h
Opsiyonlar	Acil Aydınlatma (1-3 saat)	Busbar			



Largo Frozen

Soğuk Hava Deposu Etanjı

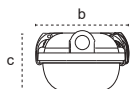

Kod	Güç (W)	Renk Sıcaklığı (K)	Işık Akısı (lm)	Etkinlik Faktörü (lm/W)	Boyutlar (mm)axbxc	Koli Ağırlığı (kg)	Koli Adedi	Fiyat
105884	42	6500	4620	110	1273x85x85	15	6	230,10\$
105894	63	6500	6930	110	1573x85x85	16	6	241,60\$



Özellikler	GRP	PC Difüzör	3000/4000/6500K	IP65	50.000h
Opsiyonlar	Busbar				



-40°C'ye Kadar Çalışır.
Soğuk hava depoları ve donuk ürün depoları kullanımı için uygundur.



Tekli
Duy

Largo
LED Tube Etanj x1

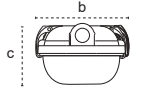

Kod	Duy	Renk Sıcaklığı (K)	Işık Akısı (lm)	Etkinlik Faktörü (lm/W)	Boyutlar (mm)axbxc	Koli Ağırlığı (kg)	Koli Adedi	Fiyat
102669	G13	-	-	-	663x85x85	11	6	16,05\$
102713	G13	-	-	-	1273x85x85	17	6	21,65\$
102867	G13	-	-	-	1573x85x85	21,5	6	37,95\$



- Özellikler** → GRP Şeffaf Difüzör IP65
- Opsiyonlar** → Acil Aydınlatma (1 saat) Busbar



Çiftli
Duy

Largo
LED Tube Etanj x2

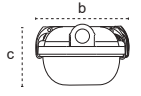

Kod	Duy	Renk Sıcaklığı (K)	Işık Akısı (lm)	Etkinlik Faktörü (lm/W)	Boyutlar (mm)axbxc	Koli Ağırlığı (kg)	Koli Adedi	Fiyat
102687	2xG13	-	-	-	663x85x125	12,8	6	16,75\$
102744	2xG13	-	-	-	1273x85x125	18,5	6	22,95\$
102878	2xG13	-	-	-	1573x85x125	25	6	40,35\$



- Özellikler** → GRP Şeffaf Difüzör IP65
- Opsiyonlar** → Acil Aydınlatma (1 saat) Busbar

Yeni Ürün



MGA Gemi Armatürü

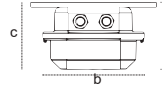

Kod	Duy	Renk Sıcaklığı (K)	Işık Akısı (lm)	Etkinlik Faktörü (lm/W)	Boyutlar (mm)axbxc	Koli Ağırlığı (kg)	Koli Adedi	Fiyat
206616	2x18	-	-	-	185x690x115	3,4	1	112,50\$

- Özellikler** → Metal PC IP67 30.000h Elektronik Balastlı

LED Tube 9W 600mm



Kod	Güç (W)	Renk Sıcaklığı (K)	Işık Akısı (lm)	Etkinlik Faktörü (lm/W)	Enerji Tüketimi (kwh/1000h)	Boyutlar (mm)axbxc	Koli Ağırlığı (kg)	Koli Adedi	Fiyat
314663	9	4000	950	105	9	602x26	4,3	25	4,80\$
314664	9	6500	950	105	9	602x26	4,3	25	4,80\$



- Özellikler** → Cam Opal Difüzör 4000/6500K 30.000h

LED Tube 18W 1200mm



Kod	Güç (W)	Renk Sıcaklığı (K)	Işık Akısı (lm)	Etkinlik Faktörü (lm/W)	Enerji Tüketimi (kwh/1000h)	Boyutlar (mm)axbxc	Koli Ağırlığı (kg)	Koli Adedi	Fiyat
314666	18	4000	1800	100	18	1214x26	8,6	25	5,20\$
314665	18	6500	1800	100	18	1214x26	8,6	25	5,20\$



- Özellikler** → Cam Opal Difüzör 4000/6500K 30.000h

LED Tube 22W 1500mm



Kod	Güç (W)	Renk Sıcaklığı (K)	Işık Akısı (lm)	Etkinlik Faktörü (lm/W)	Enerji Tüketimi (kwh/1000h)	Boyutlar (mm)axbxc	Koli Ağırlığı (kg)	Koli Adedi	Fiyat
314669	22	4000	2220	101	22	1510x26	10,5	25	10,40\$
314668	22	6500	2220	101	22	1510x26	10,5	25	10,40\$



- Özellikler** → Cam Opal Difüzör 4000/6500K 30.000h





Lenta
IP65 Kanopi Armatür



Sıva Üstü Farkı
19.00 \$

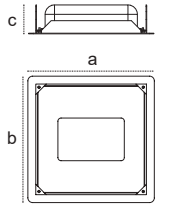

Kod	Güç (W)	Renk Sıcaklığı (K)	Işık Akısı (lm)	Etkinlik Faktörü (lm/W)	Boyutlar (mm)axbxc	Koli Ağırlığı (kg)	Koli Adedi	Fiyat
110507	100	5000	10000	100	400x400x88	5,2	1	116,75\$

Özellikler → Alüminyum Temperli Cam 5000K IP65 30.000h



Okta
IP65 Kanopi Armatür

Lens Farkı
28.00 \$

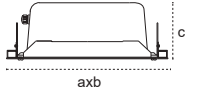

Kod	Güç (W)	Renk Sıcaklığı (K)	Işık Akısı (lm)	Etkinlik Faktörü (lm/W)	Boyutlar (mm)axbxc	Koli Ağırlığı (kg)	Koli Adedi	Fiyat
106627	80	6500	11200	140	400x400x140	4,8	1	162,30\$
110173	100	6500	11000	110	400x400x100	4,8	1	201,50\$

Özellikler → Alüminyum Temperli Cam 3000/4000/6500K IP65 50.000h
Opsiyonlar → DALI 1-10V Step DIM Acil Aydınlatma (1-3 saat)



Piriliz
IP65 Kanopi Armatür

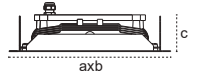

Kod	Güç (W)	Renk Sıcaklığı (K)	Işık Akısı (lm)	Etkinlik Faktörü (lm/W)	Boyutlar (mm)axbxc	Koli Ağırlığı (kg)	Koli Adedi	Fiyat
109937	75	6500	8625	115	395x385x132	8	1	369,90\$
109938	100	6500	11000	110	395x385x132	8	1	369,90\$
109939	125	6500	13125	105	395x385x132	8	1	369,90\$

Özellikler → Alüminyum Temperli Cam 3000/4000/6500K IP65 50.000h 5 Yıl
Opsiyonlar → DALI 1-10V Step DIM Acil Aydınlatma (1-3 saat) 30° / 60° / 90°



Piriliz Ex-Proof
IP65 Kanopi Armatür

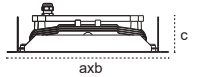

Kod	Güç (W)	Renk Sıcaklığı (K)	Işık Akısı (lm)	Etkinlik Faktörü (lm/W)	Boyutlar (mm)axbxc	Koli Ağırlığı (kg)	Koli Adedi	Fiyat
111376	50	6500	8250	165	395x385x132	8	1	398,00\$
111375	75	6500	12000	160	395x385x132	8	1	450,00\$
111374	100	6500	15500	155	395x385x132	8	1	502,00\$
111382	125	6500	19000	152	395x385x132	8	1	553,00\$
111373	150	6500	22500	150	395x385x132	8	1	604,00\$
111056	200	6500	28600	143	395x385x132	8	1	667,00\$

Özellikler → Alüminyum Temperli Cam 3000/4000/6500K IP66 50.000h
Opsiyonlar → DALI 30° / 60° / 90°

Gaz patlama koruması : II 3G Ex ec IIC T5 Gc
Toz patlama koruması : II 3D Ex tc IIIC (T95 °C) Dc



24V_{dc}, 24V_{dc/ac}, 110V_{ac} Ürün Ailesi

24 V_{dc}

24 V_{dc/ac}

110 V_{ac}



Makine Dairesi

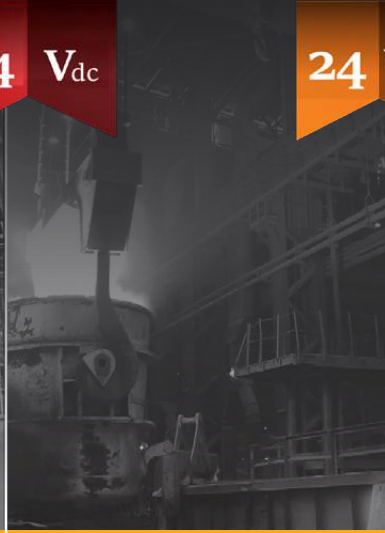

Zorlu Ortamlar



Tersaneler



Şantiyeler



24V_{dc} Sterio IP66 Projektör

24 V_{dc}

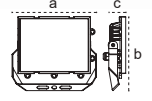

Kod	Güç (W)	Renk Sıcaklığı (K)	Işık Akısı (lm)	Etkinlik Faktörü (lm/W)	Boyutlar (mm)axbxc	Koli Ağırlığı (kg)	Koli Adedi	Fiyat
110171	50	5700	5000	100	225x195x59	8,75	6	74,50\$



Özellikler



Opsiyonlar



24V_{dc} Sterio IP66 Projektör

24 V_{dc}

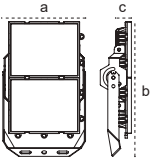

Kod	Güç (W)	Renk Sıcaklığı (K)	Işık Akısı (lm)	Etkinlik Faktörü (lm/W)	Boyutlar (mm)axbxc	Koli Ağırlığı (kg)	Koli Adedi	Fiyat
110506	100	5700	10000	100	225x365x85	10	4	134,00\$



Özellikler



Opsiyonlar



24V_{dc} Largo Etanj

24 V_{dc}

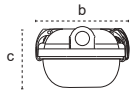

Kod	Güç (W)	Renk Sıcaklığı (K)	Işık Akısı (lm)	Etkinlik Faktörü (lm/W)	Boyutlar (mm)axbxc	Koli Ağırlığı (kg)	Koli Adedi	Fiyat
110119	21	6500	2100	100	663x85x85	7,5	6	60,25\$
110114	42	6500	4200	100	1273x85x85	12	6	66,25\$



Özellikler



Opsiyonlar

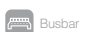



24Vdc/ac Trada

Projektör

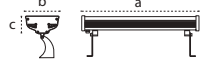
24 V_{ac/ac}

Kod	Güç (W)	Renk Sıcaklığı (K)	Işık Akısı (lm)	Etkinlik Faktörü (lm/W)	Boyutlar (mm)axbxc	Koli Ağırlığı (kg)	Koli Adedi	Fiyat
209183	24	6500	2328	97	205x155x100	1,35	1	127,30\$
209184	38	6500	3724	98	369x155x100	2,24	1	190,30\$



Özellikler →  Alüminyum  Temperli Cam  3000/4000/6500K  IP67  50.000h



24Vdc/ac Trada

Linear Armatür

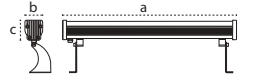
24 V_{ac/ac}

Kod	Güç (W)	Renk Sıcaklığı (K)	Işık Akısı (lm)	Etkinlik Faktörü (lm/W)	Boyutlar (mm)axbxc	Koli Ağırlığı (kg)	Koli Adedi	Fiyat
209187	8	6500	728	91	185x56x87	0,46	1	51,30\$
209190	16	6500	1600	100	245x56x87	0,75	1	58,70\$
209193	24	6500	2328	97	495x56x87	1,02	1	87,20\$



Özellikler →  Alüminyum  Temperli Cam  3000/4000/6500K  IP67  50.000h



110Vac Ria Med G2

Projektör

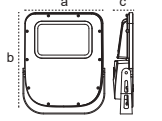
110 V_{ac}

Kod	Güç (W)	Renk Sıcaklığı (K)	Işık Akısı (lm)	Etkinlik Faktörü (lm/W)	Boyutlar (mm)axbxc	Koli Ağırlığı (kg)	Koli Adedi	Fiyat
111788	60	6500	8820	147	340x274x66	15,05	4	131,50\$
111785	80	6500	11360	142	340x274x66	15,05	4	166,50\$
111660	100	6500	13900	138	340x274x66	15,05	4	166,50\$
111666	150	6500	19050	127	340x274x66	15,05	4	194,50\$



Özellikler →  Alüminyum  Temperli Cam  3000/4000/6500K  IP66  62.000h

Opsiyonlar →  30°/60°/90°/Asimetrik*

*Asimetrik Lens 50-150W arasında bulunmaktadır.



110Vac Doka G2

Yol ve Cadde Armatürü

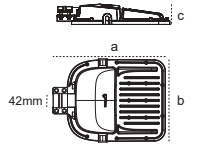
110 V_{ac}

Kod	Güç (W)	Renk Sıcaklığı (K)	Işık Akısı (lm)	Etkinlik Faktörü (lm/W)	Boyutlar (mm)axbxc	Konsol	Koli Ağırlığı (kg)	Koli Adedi	Fiyat
115410	60	4000	8820	147	362x268x65x316	42	11,8	4	161,00\$
115412	80	4000	11360	142	362x268x65x316	42	11,8	4	172,00\$
115414	100	4000	13800	138	362x268x65x316	42	11,8	4	181,50\$
115416	150	4000	19050	127	362x268x65x316	42	11,8	4	223,50\$



Özellikler →  Alüminyum  Temperli Cam  3000/4000/6500K  IP66  62.000h

Cronto IP66

5
YIL
GARANTİ



En Zor Koşullarda 7/24 Yüksek Performans

Driver
Üstünlükleri



ENEC Belgesi
Sürücü



100.000 h
Driver Ömrü



10kV Dahili
Parafudr



-40°C +55°C



IP67



100-277Vac
Gerilim Dalgalanmalarından Etkilenmez



+70°C Opsiyon

Cronto IP66 150-200W

Kod	Güç (W)	Renk Sıcaklığı (K)	Işık Akısı (lm)	Etkinlik Faktörü (lm/W)	Boyutlar (mm)axbxc	Koli Ağırlığı (kg)	Koli Adedi	Fiyat
111333	150	5700	22350	149	230x555x135	12	1	357,00\$
111334	200	5700	28800	144	230x555x135	12	1	378,00\$

Özellikler	Alüminyum	Temperli Cam	4000/5700/6500K	IP66	62.000h	5 Yıl	
Opsiyonlar	DALI	1-10V	Step DIM	Acil Aydınlatma (1-3 saat)	Radar Sensör	Busbar	30° / 60° / 90°

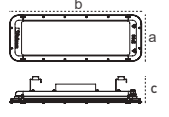

+70°C Opsiyon

Cronto IP66 250-300W

Kod	Güç (W)	Renk Sıcaklığı (K)	Işık Akısı (lm)	Etkinlik Faktörü (lm/W)	Boyutlar (mm)axbxc	Koli Ağırlığı (kg)	Koli Adedi	Fiyat
111331	250	5700	36000	144	230x655x135	15	1	472,50\$
111332	300	5700	42300	141	230x655x135	15	1	472,50\$

Özellikler	Alüminyum	Temperli Cam	4000/5700/6500K	IP66	62.000h	5 Yıl	
Opsiyonlar	DALI	1-10V	Step DIM	Acil Aydınlatma (1-3 saat)	Radar Sensör	Busbar	30° / 60° / 90°

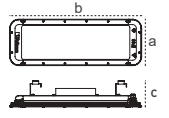

+70°C Opsiyon

Cronto IP66 350-400W

Kod	Güç (W)	Renk Sıcaklığı (K)	Işık Akısı (lm)	Etkinlik Faktörü (lm/W)	Boyutlar (mm)axbxc	Koli Ağırlığı (kg)	Koli Adedi	Fiyat
111335	350	5700	48650	139	230x760x135	19	1	625,50\$
111336	400	5700	54800	137	230x760x135	19	1	625,50\$

Özellikler	Alüminyum	Temperli Cam	4000/5700/6500K	IP66	62.000h	5 Yıl	
Opsiyonlar	DALI	1-10V	Step DIM	Acil Aydınlatma (1-3 saat)	Radar Sensör	Busbar	30° / 60° / 90°

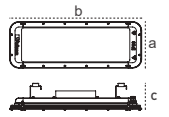

Etna G2

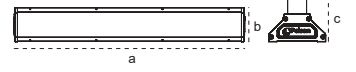

**7/24 Çalışan
Endüstriyel
Tesislerde
Ultra Performans!**



Kod	Tip	Güç (W)	Renk Sıcaklığı (K)	Işık Akısı (lm)	Etkinlik Faktörü (lm/W)	Boyutlar (mm)axbxc	Koli Ağırlığı (kg)	Koli Adedi	Fiyat
111273	45°	100	6500	13300	133	590x86x178	4,1	1	158,90\$
111271	45°	150	6500	19950	133	870x86x178	6,3	1	222,50\$
111269	45°	200	6500	26800	134	1150x86x178	7,9	1	329,00\$
111258	45°	250	6500	33250	133	1430x86x178	9,8	1	390,50\$
111256	45°	300	6500	38400	128	1430x86x178	9,8	1	390,50\$
111272	55°	100	6500	13300	133	590x86x178	4,1	1	158,90\$
111270	55°	150	6500	19950	133	870x86x178	6,3	1	222,50\$
111259	55°	200	6500	26800	134	1150x86x178	7,9	1	329,00\$
111257	55°	250	6500	33250	133	1430x86x178	9,8	1	390,50\$
111255	55°	300	6500	38400	128	1430x86x178	9,8	1	390,50\$

Özellikler	Alüminyum	Temperli Cam	4000/5700/6500K	IP65	50.000h	5 Yıl
Opsiyonlar	DALI	1-10V	Acil Aydınlatma (1-3 saat)	Radar Sensör	Busbar	

Etna G2 Heavy Industry

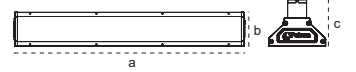

**Ağır Sanayi
Tesisleri için
Ultra Performans!**



+70° C'ye Kadar Çalışır.

Kod	Tip	Güç (W)	Renk Sıcaklığı (K)	Işık Akısı (lm)	Etkinlik Faktörü (lm/W)	Boyutlar (mm)axbxc	Koli Ağırlığı (kg)	Koli Adedi	Fiyat
113986	45°	80	6500	10640	133	1150x86x178	4,1	1	278,70\$
113466	45°	100	6500	13300	133	1150x86x178	6,3	1	349,50\$
113467	45°	200	6500	26800	134	1430x86x178	7,9	1	454,50\$

Özellikler	Alüminyum	Temperli Cam	4000/5700/6500K	IP65	50.000h
Opsiyonlar	DALI	1-10V	Radar Sensör	Busbar	

Etna G2 Food

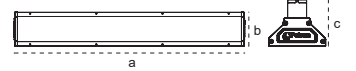

**Gıda
Tesisleri için
Ultra Performans!**



Kod	Tip	Güç (W)	Renk Sıcaklığı (K)	Işık Akısı (lm)	Etkinlik Faktörü (lm/W)	Boyutlar (mm)axbxc	Koli Ağırlığı (kg)	Koli Adedi	Fiyat
113336	45°	100	6500	13300	133	590x86x178	4,1	1	211,70\$
113338	45°	150	6500	19950	133	870x86x178	6,3	1	275,50\$
133340	45°	200	6500	26800	134	1150x86x178	7,9	1	385,00\$
133342	45°	250	6500	33250	133	1430x86x178	9,8	1	446,50\$
133344	45°	300	6500	38400	128	1430x86x178	9,8	1	446,50\$

Özellikler	Alüminyum	Temperli Cam	4000/5700/6500K	IP65	50.000h
Opsiyonlar	DALI	1-10V	Radar Sensör	Busbar	

Etna G2 Frozen

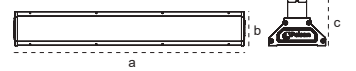

**Soğuk Hava
Depoları için
Ultra Performans!**



-40° C'ye Kadar Çalışır.

Kod	Tip	Güç (W)	Renk Sıcaklığı (K)	Işık Akısı (lm)	Etkinlik Faktörü (lm/W)	Boyutlar (mm)axbxc	Koli Ağırlığı (kg)	Koli Adedi	Fiyat
113337	45°	100	6500	13300	133	590x86x178	4,1	1	265,00\$
113339	45°	150	6500	19950	133	870x86x178	6,3	1	328,00\$
133341	45°	200	6500	26800	134	1150x86x178	7,9	1	439,00\$
133343	45°	250	6500	33250	133	1430x86x178	9,8	1	487,75\$
133345	45°	300	6500	38400	128	1430x86x178	9,8	1	487,75\$

Özellikler	Alüminyum	Temperli Cam	4000/5700/6500K	IP65	50.000h
Opsiyonlar	DALI	1-10V	Acil Aydınlatma (1-3 saat)	Radar Sensör	Busbar



75-100W
Ø295



150-200W
Ø345



Ürün Tanıtım Broşürü

154lm/W'a Varan Etkinlik Faktörü

Acil Kit

Reflektör Opsiyonu

45°/90° Lens Seçeneği

Driver Üstünlükleri

ENECE Belgesi Sürücü

100.000 h Driver Ömrü

10kV Dahili Parafudr

-40°C +55°C

IP67

100-277Vac Gerilim Dalgalanmalarından Etkilenmez



Castor G3 75W-100W

Kod	Tip	Güç (W)	Renk Sıcaklığı (K)	Işık Akısı (lm)	Etkinlik Faktörü (lm/W)	Boyutlar (mm)Øxh	Koli Ağırlığı (kg)	Koli Adedi	Fiyat
114042	90°	75	5700	11550	154	272x180	16,8	6	152,50\$
114043	90°	100	5700	14900	149	272x180	16,8	6	163,75\$

Özellikler	Alüminyum	PC Difüzör	4000/5700/6500K	IP65	62.000h	5 Yıl
Opsiyonlar	DALI	1-10V	Acil Aydınlatma (1-3 saat)	Radar Sensör	Sarkit	45° / 90° Lens

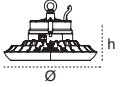

Castor G3 150W-200W

Kod	Tip	Güç (W)	Renk Sıcaklığı (K)	Işık Akısı (lm)	Etkinlik Faktörü (lm/W)	Boyutlar (mm)Øxh	Koli Ağırlığı (kg)	Koli Adedi	Fiyat
114044	90°	150	5700	21900	146	323x186	12,8	4	222,75\$
114045	90°	200	5700	28400	142	323x186	12,8	4	273,50\$

Özellikler	Alüminyum	PC Difüzör	4000/5700/6500K	IP65	62.000h	5 Yıl
Opsiyonlar	DALI	1-10V	Acil Aydınlatma (1-3 saat)	Radar Sensör	Sarkit	45° / 90° Lens

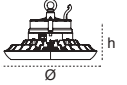

Monte G2 100W

Kod	Güç (W)	Renk Sıcaklığı (K)	Işık Akısı (lm)	Etkinlik Faktörü (lm/W)	Boyutlar (mm)Øxh	Koli Ağırlığı (kg)	Koli Adedi	Fiyat
110569	100	5700	11500	115	272x180	9,6	6	119,25\$

Özellikler	Alüminyum	Temperli Cam	5700K	IP65	30.000h
------------	-----------	--------------	-------	------	---------

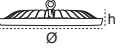

Monte G2 150W

Kod	Güç (W)	Renk Sıcaklığı (K)	Işık Akısı (lm)	Etkinlik Faktörü (lm/W)	Boyutlar (mm)Øxh	Koli Ağırlığı (kg)	Koli Adedi	Fiyat
110570	150	5700	18450	123	323x186	11,6	4	167,25\$

Özellikler	Alüminyum	Temperli Cam	5700K	IP65	30.000h
------------	-----------	--------------	-------	------	---------

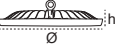

Kod	Özellikler	Koli Adedi	Fiyat
325718	Castor G2 Busbar Askı Takımı	1	3,90\$
325458	Castor G2 Kamaşma Önleyici Reflektör	1	19,90\$



Yenilenen KARPAT G3

Yeni hibrit gövde (Metal+Alüminyum)
Daha etkin ısı tahliyesi

126 lm/W'a varan etkinlik faktörü
%26 verimlilik artışı

Avrupa menşei sürücü

Ekonomik Fiyat

Düşük amortisman

Yeni Ürün



Karpat G3

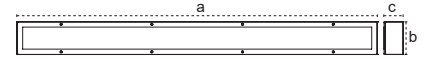

Kod	Güç (W)	Renk Sıcaklığı (K)	Işık Akısı (lm)	Etkinlik Faktörü (lm/W)	Boyutlar (mm)axbxc	Koli Ağırlığı (kg)	Koli Adedi	Fiyat
115811	75	6500	9150	122	600x110x60	4,4	2	69,90\$
115812	110	6500	13860	126	880x110x60	6,5	2	103,50\$
115813	140	6500	17500	125	1160x110x60	8	2	141,25\$







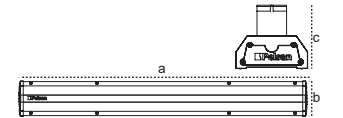



Özellikler	 Metal / Alüminyum	 Temperli Cam	 3000/4000/6500K	 IP65	 50.000h
Opsiyonlar	 DALI	 1-10V	 Acil Aydınlatma (1-3 saat)	 Busbar	



Hima G2



Kod	Güç (W)	Renk Sıcaklığı (K)	Işık Akısı (lm)	Etkinlik Faktörü (lm/W)	Boyutlar (mm)axbxc	Koli Ağırlığı (kg)	Koli Adedi	Fiyat
111072	75	6500	9000	120	865x115x80	4,5	1	117,60\$
111073	100	6500	11500	115	865x115x80	4,5	1	126,30\$
111066	150	6500	17250	115	1145x115x80	6	1	154,30\$

Özellikler	 Alüminyum	 Temperli Cam	 4000/5700/6500K	 IP65	 50.000h
Opsiyonlar	 DALI	 1-10V	 Acil Aydınlatma (1-3 saat)	 Radar Sensör	 Busbar

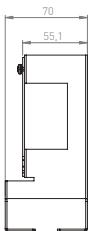

Busbar Aparatı
316387

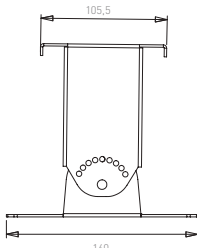

Açı Ayarlı Montaj Aparatı
321804

Kod	Özellikler	Koli Adedi	Fiyat
316387	Etna G2/ Hima G2/ Karpat G3 Busbar Askı Takımı	1	7.30\$
321804	Etna G2/ Hima G2/ Karpat G3 Açık Ayarlı Bağlantı Takımı	1	10.30\$

Endüstriyel Aydınlatmada **MAX AİLESİ**



INOVALED MAX

- 5 Yıl Garanti
- Alüminyum Gövde
- 150W/18750 lm
- 125lm/W'a Varan Etkinlik Faktörü
- IP66 Toz ve Su Geçirmez
- Temperli Cam
- Açı Ayarlı Montaj İmkanı



FOLTA MAX

- 5 Yıl Garanti
- PC, Kırılmaz Gövde
- 65W / 7150 lm
- 115 lm/W'a Varan Etkinlik Faktörü
- IP65
- Kolay Montaj

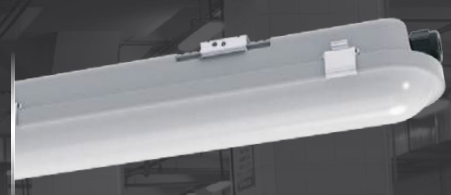

LARGO MAX

- 5 Yıl Garanti
- PC Gövde
- 100W/12400 lm
- 132lm/W'a Varan Etkinlik Faktörü
- IP65
- Kolay Montaj

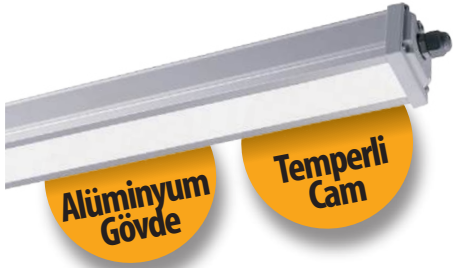

Inovaled Max

Kod	Güç (W)	Renk Sıcaklığı (K)	Işık Akısı (lm)	Etkinlik Faktörü (lm/W)	Boyutlar (mm)axbxc	Koli Ağırlığı (kg)	Koli Adedi	Fiyat
113643	100	6500	12300	123	910x72x59	10,7	6	116,25\$
113644	120	6500	15000	125	1190x72x59	14,7	6	141,50\$
113645	150	6500	18750	125	1470x72x59	19,7	6	154,25\$

- Özellikler** Alüminyum Temperli Cam 3000/4000/6500K IP66 50.000h 5 Yıl
- Opsiyonlar** DALI Acil Aydınlatma (1-3 saat) Busbar

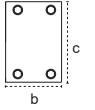

Folta Max

Kod	Güç (W)	Renk Sıcaklığı (K)	Işık Akısı (lm)	Etkinlik Faktörü (lm/W)	Boyutlar (mm)axbxc	Koli Ağırlığı (kg)	Koli Adedi	Fiyat
115754	53	6500	6095	115	1305x64x46	13,5	12	47,90\$
115756	65	6500	7150	110	1305x64x46	13,5	12	50,50\$

- Özellikler** PC Opal Difüzör 3000/4000/6500K IP65 50.000h 5 Yıl
- Opsiyonlar** DALI 1-10V Acil Aydınlatma (1-3 saat) Busbar IP66

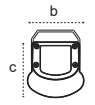

Largo Max

Kod	Güç (W)	Renk Sıcaklığı (K)	Işık Akısı (lm)	Etkinlik Faktörü (lm/W)	Boyutlar (mm)axbxc	Koli Ağırlığı (kg)	Koli Adedi	Fiyat
116063	50	6500	6600	132	1150x80x75	14,7	6	62,25\$
116064	75	6500	9375	125	1150x80x75	14,7	6	80,40\$
116067	100	6500	12400	124	1500x80x75	19,1	6	93,50\$

- Özellikler** PC Opal Difüzör 3000/4000/6500K IP65 50.000h 5 Yıl
- Opsiyonlar** DALI 1-10V Acil Aydınlatma (1-3 saat) Radar Sensör Busbar

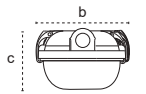



**ATEX Belgeli
Ex-Proof Armatürler**

Pelsan

ürün
broşürü



Pelsan **Ex-Proof** Armatürleri

Kimya ve boya tesisleri, petrol depolama tesisleri,
petrol dolum boşaltım tesisleri,
liman & tersaneler, enerji santralleri, endüstriyel
tesisler ve akaryakıt istasyonlarında

güvenle kullanabilirsiniz!





Zone 1, Zone 21 ATEX Belgeli Ex-Proof Armatürler

Pelsan



ZONE 1
ZONE 21
II 2G Ex db IIB T6 Gb
II 2D Ex tb IIIC (T85°C) Db



Exta Ex-Proof Etanj Armatür

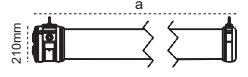

Kod	Güç (W)	Renk Sıcaklığı (K)	Işık Akısı (lm)	Etkinlik Faktörü (lm/W)	Boyutlar (mm)axbxc	Koli Ağırlığı (kg)	Koli Adedi	Fiyat
115871	14	6500	2030	145	430x182x168	3,8	1	646,00\$
115872	26	6500	3692	142	710x182x162	6,5	1	692,00\$
115490	35	6500	4900	140	1270x182x162	10,5	1	739,00\$
115873	50	6500	7000	140	1270x182x162	10,5	1	739,00\$

Özellikler	Alüminyum	PC Difüzör	3000/4000/6500K	IP66	50.000h
Opsiyonlar	DALI	1-10V	Acil Aydınlatma (1-3 saat)	Radarsensör	



ZONE 1
ZONE 21
II 2G Ex db IIB T6 Gb
II 2D Ex tb IIIC (T85°C) Db



Exta Ex-Proof Yüksek Tavan Armatürü

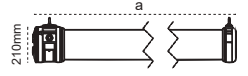

Kod	Güç (W)	Renk Sıcaklığı (K)	Işık Akısı (lm)	Etkinlik Faktörü (lm/W)	Boyutlar (mm)axbxc	Koli Ağırlığı (kg)	Koli Adedi	Fiyat
115874	75	6500	10500	140	1270x182x162	10,5	1	767,00\$
115875	100	6500	13600	136	1552x182x162	13	1	1.015,00\$
115489	150	6500	20400	136	1552x182x162	13	1	1.109,00\$

Özellikler	Alüminyum	PC Difüzör	3000/4000/6500K	IP66	50.000h
Opsiyonlar	DALI	1-10V	Acil Aydınlatma (1-3 saat)	Radarsensör	



ZONE 1
ZONE 21
II 2G Ex db IIB T4 Gb
II 2D Ex tb IIIC (T130°C) Db



Atarex Ex-Proof Yüksek Tavan Armatürü

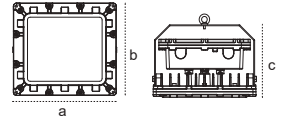

Kod	Güç (W)	Renk Sıcaklığı (K)	Işık Akısı (lm)	Etkinlik Faktörü (lm/W)	Boyutlar (mm)axbxc	Koli Ağırlığı (kg)	Koli Adedi	Fiyat
115866	50	6500	6000	120	342x307x241	15,3	1	1.339,00\$
115867	100	6500	13200	132	342x307x241	15,3	1	1.339,00\$
115868	150	6500	19350	129	342x307x241	15,3	1	1.339,00\$
115869	200	6500	25000	125	342x307x241	15,3	1	1.911,00\$
115870	240	6500	29520	123	342x307x241	15,3	1	2.308,00\$

Özellikler	Alüminyum	Temperli Cam	3000/4000/6500K	IP66	50.000h
Opsiyonlar	DALI	1-10V	Acil Aydınlatma (1-3 saat)	RAL Kod	30° / 60° / 90°



ZONE 1
ZONE 21
II 2G Ex db IIB T4 Gb
II 2D Ex tb IIIC (T130°C) Db



Atarex Ex-Proof Projektör

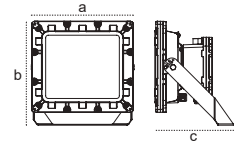

Kod	Güç (W)	Renk Sıcaklığı (K)	Işık Akısı (lm)	Etkinlik Faktörü (lm/W)	Boyutlar (mm)axbxc	Koli Ağırlığı (kg)	Koli Adedi	Fiyat
115486	50	6500	6000	120	342x350x264	15,5	1	1.339,00\$
115865	100	6500	13200	132	342x350x264	15,5	1	1.339,00\$
115864	150	6500	19350	129	342x350x264	15,5	1	1.339,00\$
115863	200	6500	25000	125	342x350x264	15,5	1	1.911,00\$
115487	240	6500	29520	123	342x350x264	15,5	1	2.308,00\$
115780	480	6500	50400	105	438x754x488	24,9	1	4.617,00\$

Özellikler	Alüminyum	Temperli Cam	3000/4000/6500K	IP66	50.000h
Opsiyonlar	DALI	1-10V	Acil Aydınlatma (1-3 saat)	RAL Kod	30° / 60° / 90°



ZONE 1
ZONE 21
II 2G Ex db IIB T4 Gb
II 2D Ex tb IIIC (T130°C) Db



Exta Exit Ex-Proof Acil Yönlendirme ve Aydınlatma Armatürü

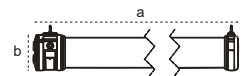

Kod	Güç (W)	Batarya	Şarj Süresi	Renk Sıcaklığı (K)	Işık Akısı (lm)	Etkinlik Faktörü (lm/W)	Boyutlar (mm)axbxc	Koli Ağırlığı (kg)	Koli Adedi	Fiyat
115488	8	3,7V 4500mAh	3h.	6500	480	60	182x465x168	3,8	1	480,00\$

Özellikler	Alüminyum	PC Difüzör	3000/4000/6500K	IP66	50.000h	Acil Aydınlatma (1-3 saat)
------------	-----------	------------	-----------------	------	---------	----------------------------





Zone2, Zone22 ATEX Belgeli Ex-Proof Armatürler

Pelsan

• Toz Patlama Koruması: Zone 22 • Gaz Patlama Koruması: Zone 2



ZONE 2
ZONE 22 II 3G Ex ec IIC T5 Gc
II 3D Ex tc IIIC (T95°C) DC



Ausled

Ex-Proof Acil Aydınlatma

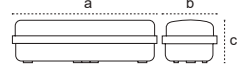

Kod	Güç (W)	Batarya	Şarj Süresi	Deşarj Süresi	Işık Akısı (lm)	Renk Sıcaklığı (K)	Etkinlik Faktörü (lm/W)	Boyutlar (mm)axbxc	Koli Ağırlığı (kg)	Koli Adedi	Fiyat
109710	15	3,7V 4500mAh	24h	3h	1500	6500	100	350x117x76	5,5	6	108,50\$

Özellikler: PC, PC Difüzör, 3000/400/6500K, IP65, 50.000h



ZONE 2
ZONE 22 II 3G Ex ec IIC T5 Gc
II 3D Ex tc IIIC (T95°C) DC



Largo LED Tube

Ex-Proof Etanj

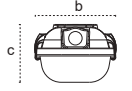

Kod	Güç (W)	Duy	Boyutlar (mm)axbxc	Koli Ağırlığı (kg)	Koli Adedi	Fiyat
111402	1x9 max	1xG13	670x85x125	11	6	93,00\$
111404	2x9 max	2xG13	670x85x125	12,8	6	98,00\$
111405	1x18 max	1xG13	1280x85x125	17	6	117,00\$
111406	2x18 max	2xG13	1280x85x125	18,5	6	119,00\$

Özellikler: GRP, PC Difüzör, IP65, 50.000h



ZONE 2
ZONE 22 II 3G Ex ec IIC T5 Gc
II 3D Ex tc IIIC (T95°C) DC



Largo LED

Ex-Proof Etanj

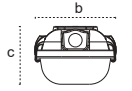

Kod	Tip	Güç (W)	Renk Sıcaklığı (K)	Işık Akısı (lm)	Etkinlik Faktörü (lm/W)	Boyutlar (mm)axbxc	Koli Ağırlığı (kg)	Koli Adedi	Fiyat
108458	Opal	25	6500	2750	110	670x85x125	12,8	6	213,50\$
108459	Opal	45	6500	4950	110	1280x85x125	18,5	6	229,25\$

Özellikler: GRP, PC Difüzör, 3000/400/6500K, IP65, 50.000h

Opsiyonlar: Acil Aydınlatma (1-3 saat)



ZONE 2
ZONE 22 II 3G Ex ec IIC T5 Gc
II 3D Ex tc IIIC (T95°C) DC



Largo T8

Ex-Proof Etanj

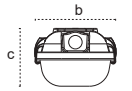

Kod	Güç (W)	Duy	Boyutlar (mm)axbxc	Koli Ağırlığı (kg)	Koli Adedi	Fiyat
108297	2x18	2xG13	670x85x125	12,8	6	128,90\$
108298	2x36	2xG13	1280x85x125	18,5	6	133,75\$

Özellikler: GRP, PC Difüzör, IP65, 50.000h



Zone2, Zone22 ATEX Belgeli Ex-Proof Armatürler

Pelsan

● Toz Patlama Koruması: Zone 22 ● Gaz Patlama Koruması: Zone 2



ZONE 2
ZONE 22
II 3G Ex ec IIC T5 Gc
II 3D Ex tc IIIC (T95°C) DC



Nairo

Ex-Proof Projektör

Kod	Güç (W)	Renk Sıcaklığı (K)	Işık Akısı (lm)	Etkinlik Faktörü (lm/W)	Boyutlar (mm)axbxc	Koli Ağırlığı (kg)	Koli Adedi	Fiyat
111372	50	6500	8250	165	342x342x158	8	1	398,00\$
111371	75	6500	12000	160	342x342x158	8	1	450,00\$
111370	100	6500	15500	155	342x342x158	8	1	502,00\$
111369	125	6500	19000	152	342x342x158	8	1	553,00\$
111368	150	6500	22500	150	342x342x158	8	1	604,00\$
111055	200	6500	28600	143	342x342x158	8	1	667,00\$

Özellikler Alüminyum Temperli Cam 4000/5700/6500K IP66 50.000h
Opsiyonlar 30°/60°/90°



ZONE 2
ZONE 22
II 3G Ex ec IIC T5 Gc
II 3D Ex tc IIIC (T95°C) DC



Sia

Ex-Proof Yüksek Tavan Armatürü

Kod	Güç (W)	Renk Sıcaklığı (K)	Işık Akısı (lm)	Etkinlik Faktörü (lm/W)	Boyutlar (mm)axbxc	Koli Ağırlığı (kg)	Koli Adedi	Fiyat
111381	50	6500	8250	165	342x342x175	8	1	398,00\$
111380	75	6500	12000	160	342x342x175	8	1	450,00\$
111379	100	6500	15500	155	342x342x175	8	1	502,00\$
111378	125	6500	19000	152	342x342x175	8	1	553,00\$
111377	150	6500	22500	150	342x342x175	8	1	604,00\$
111053	200	6500	28600	143	342x342x175	8	1	667,00\$

Özellikler Alüminyum Temperli Cam 4000/5700/6500K IP66 50.000h
Opsiyonlar 30°/60°/90°

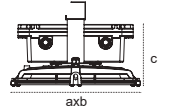

ZONE 2
ZONE 22
II 3G Ex ec IIC T5 Gc
II 3D Ex tc IIIC (T95°C) DC



Elit Lirad

Ex-Proof Projektör

Kod	Güç (W)	Renk Sıcaklığı (K)	Işık Akısı (lm)	Etkinlik Faktörü (lm/W)	Boyutlar (mm)axbxc	Koli Ağırlığı (kg)	Koli Adedi	Fiyat
109707	50	6500	7000	140	295x200x175	18	6	258,00\$

Özellikler GRP Temperli Cam 4000/5700/6500K IP65 50.000h
Opsiyonlar 30°/60°/90°

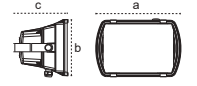

ZONE 2
ZONE 22
II 3G Ex ec IIC T5 Gc
II 3D Ex tc IIIC (T95°C) DC



Piroliz

Ex-Proof Kanopi Armatürü

Kod	Güç (W)	Renk Sıcaklığı (K)	Işık Akısı (lm)	Etkinlik Faktörü (lm/W)	Boyutlar (mm)axbxc	Koli Ağırlığı (kg)	Koli Adedi	Fiyat
111376	50	6500	8250	165	342x342x175	8	1	398,00\$
111375	75	6500	12000	160	342x342x175	8	1	450,00\$
111374	100	6500	15500	155	342x342x175	8	1	502,00\$
111382	125	6500	19000	152	342x342x175	8	1	553,00\$
111373	150	6500	22500	150	342x342x175	8	1	604,00\$
111056	200	6500	28600	143	342x342x175	8	1	667,00\$

Özellikler Alüminyum Temperli Cam 4000/5700/6500K IP66 50.000h
Opsiyonlar 30°/60°/90°

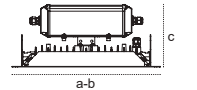

ZONE 2
ZONE 22
II 3G Ex ec IIC T5 Gc
II 3D Ex tc IIIC (T95°C) DC



Nairo SL

Ex-Proof Yol-Cadde Armatürü

Kod	Güç (W)	Renk Sıcaklığı (K)	Işık Akısı (lm)	Etkinlik Faktörü (lm/W)	Boyutlar (mm)axbxc	Konsol Girişi (mm)	Koli Ağırlığı (kg)	Koli Adedi	Fiyat
111365	100	4000	15200	152	352x352x152	42-60	8	1	518,00\$
111364	125	4000	18625	149	352x352x152	42-60	8	1	569,00\$
111363	150	4000	21900	146	352x352x152	42-60	8	1	620,00\$
111362	200	4000	28000	140	352x352x152	42-60	8	1	683,00\$

Özellikler Alüminyum Temperli Cam 4000/5700/6500K IP66 50.000h

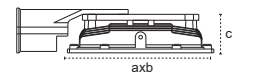

Uzun Ömürlü, Yüksek Verimli...

Gaziantep Kalesi LED Aydınlatması,
Pelsan Aydınlatma M. Reşit Göğüş tarafından
yapılmıştır.



IP66 Toz ve Su Almaz



Temperli Cam



IK08 Darbe Dayanımı



Alüminyum Gövde



Hava Ventilli Rakor ile
Nem Yapmaz!

Inovaled G2 IP66

Sıva Üstü Wallwasher



Kod	Tip	Güç (W)	Renk Sıcaklığı (K)	Işık Akısı (lm)	Etkinlik Faktörü (lm/W)	Boyutlar (mm)axbxc	Koli Ağırlığı (kg)	Koli Adedi	Fiyat
113290	45+20°	14	3000	1540	110	350x72x59	3,9	4	44,90\$
113291	45+20°	14	4000	1540	110	350x72x59	3,9	4	44,90\$
113292	45+20°	14	6500	1540	110	350x72x59	3,9	4	44,90\$

Özellikler	Alüminyum	Temperli Cam	4000/5700/6500K	IP66	50.000h
Opsiyonlar	Amber Renk	Yeşil Renk	Kırmızı Renk	Mavi Renk	

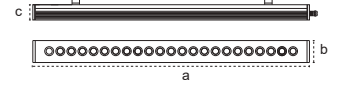

Inovaled G2 IP66

Sıva Üstü Wallwasher



Kod	Tip	Güç (W)	Renk Sıcaklığı (K)	Işık Akısı (lm)	Etkinlik Faktörü (lm/W)	Boyutlar (mm)axbxc	Koli Ağırlığı (kg)	Koli Adedi	Fiyat
113318	45+20°	28	3000	3080	110	650x72x59	5,7	4	72,10\$
113319	45+20°	28	4000	3080	110	650x72x59	5,7	4	72,10\$
113320	45+20°	28	6500	3080	110	650x72x59	5,7	4	72,10\$

Özellikler	Alüminyum	Temperli Cam	4000/5700/6500K	IP66	50.000h
Opsiyonlar	Amber Renk	Yeşil Renk	Kırmızı Renk	Mavi Renk	

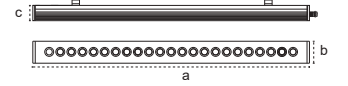

Inovaled G2 IP66

Sıva Üstü Wallwasher



Kod	Tip	Güç (W)	Renk Sıcaklığı (K)	Işık Akısı (lm)	Etkinlik Faktörü (lm/W)	Boyutlar (mm)axbxc	Koli Ağırlığı (kg)	Koli Adedi	Fiyat
113326	45+20°	42	3000	4620	110	945x72x59	7,1	4	112,80\$
113327	45+20°	42	4000	4620	110	945x72x59	7,1	4	112,80\$
113328	45+20°	42	6500	4620	110	945x72x59	7,1	4	112,80\$

Özellikler	Alüminyum	Temperli Cam	4000/5700/6500K	IP66	50.000h
Opsiyonlar	Amber Renk	Yeşil Renk	Kırmızı Renk	Mavi Renk	

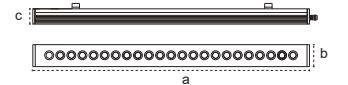

Cruzo G2

Cruzo G2

***CB, *ENEC belgeli**

1800W
LED Projektör

ürün broşürü



Driver Üstünlükleri



ENEC Belgeli Sürücü



100.000 h Driver Ömrü



10kV Dahili Parafudr



-40°C +55°C



IP67



100-277Vac Gerilim Dalgalanmalarından Etkilenmez



Cruzo IP66 500-600W
LED Projektör

10kV Dahili Parafudr

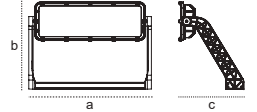

Kod	Güç (W)	Renk Sıcaklığı (K)	Işık Akısı (lm)	Etkinlik Faktörü (lm/W)	Boyutlar (mm)axbxc	Koli Ağırlığı (kg)	Koli Adedi	Fiyat
115898	500	5700	70000	140	780x558x414	19,2	1	935,00\$
115975	600	5700	84600	141	780x558x414	19,2	1	1.029,00\$



Özellikler

Alüminyum

Temperli Cam

4000/5700/6500K

IP66

62.000h

Opsiyonlar

DALI

1-10V

Step DIM

Elektriksel Sınıf I/II

10° / 30° / 60° / 90° Asimetrik



Cruzo IP66 800-1200W
LED Projektör

10kV Dahili Parafudr

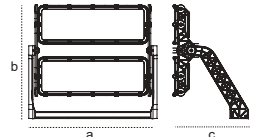

Kod	Güç (W)	Renk Sıcaklığı (K)	Işık Akısı (lm)	Etkinlik Faktörü (lm/W)	Boyutlar (mm)axbxc	Koli Ağırlığı (kg)	Koli Adedi	Fiyat
115976	800	5700	115200	144	816x723x479	34	1	1.663,00\$
115977	900	5700	128700	143	816x723x479	34	1	1.663,00\$
115899	1000	5700	142000	142	816x723x479	34	1	1.663,00\$
110798	1200	5700	170400	142	816x723x479	34	1	2.217,00\$



Özellikler

Alüminyum

Temperli Cam

4000/5700/6500K

IP66

62.000h

Opsiyonlar

DALI

1-10V

Step DIM

Elektriksel Sınıf I/II

10° / 30° / 60° / 90° Asimetrik



Cruzo IP66 1500-1800W
LED Projektör

10kV Dahili Parafudr

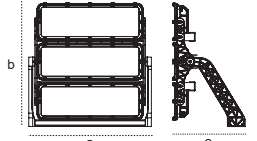

Kod	Güç (W)	Renk Sıcaklığı (K)	Işık Akısı (lm)	Etkinlik Faktörü (lm/W)	Boyutlar (mm)axbxc	Koli Ağırlığı (kg)	Koli Adedi	Fiyat
115900	1500	5700	213000	142	816x821x479	47	1	2.771,00\$
115901	1800	5700	246600	137	816x821x479	47	1	3.325,00\$



Özellikler

Alüminyum

Temperli Cam

4000/5700/6500K

IP66

62.000h

Opsiyonlar

DALI

1-10V

Step DIM

Elektriksel Sınıf I/II

Marin Boya

30° / 60° / 90° Asimetrik

*CB ve ENEC belgeleri 1200W'a kadar (Dahil) geçerlidir.



5
YIL
GARANTİŞimdi 200W
26000 lmDriver
ÜstünlükleriENEC Belgesi
Sürücü100.000 h
Driver Ömrü10kV Dahili
Parafudr

-40°C +55°C

IP67

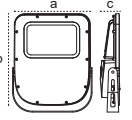
100-277Vac
Gerilim Dalgalanmalarından EtkilenmezRia Med G2 IP66
60-200W10kV Dahili
Parafudr

Kod	Güç (W)	Renk Sıcaklığı (K)	Işık Akısı (lm)	Etkinlik Faktörü (lm/W)	Boyutlar (mm)axbxc	Koli Ağırlığı (kg)	Koli Adedi	Fiyat
111788	60	6500	8820	147	274x340x66	15,05	4	131,50\$
111785	80	6500	11360	142	274x340x66	15,05	4	166,50\$
111660	100	6500	13800	138	274x340x66	15,05	4	166,50\$
111666	150	6500	19050	127	274x340x66	15,05	4	194,50\$
116136	200	6500	26000	130	274x340x66	15,05	4	341,75\$



Özellikler

Alüminyum

Temperli Cam

3000/4000/6500K

IP66

62.000h

5 Yıl



Opsiyonlar

DALI

1-10V

Step DIM

Elektriksel Sınıf I/II

Marin Boya

30° / 60° / 90° Asimetrik**

**Asimetrik Lens 50 - 100 W arasında sunulmaktadır.

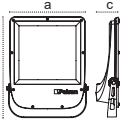
Ria IP66 Simetrik
200-400W10kV Dahili
Parafudr

Kod	Güç (W)	Renk Sıcaklığı (K)	Işık Akısı (lm)	Etkinlik Faktörü (lm/W)	Boyutlar (mm)axbxc	Koli Ağırlığı (kg)	Koli Adedi	Fiyat
115918	200	6500	28800	144	400x418x100	6	1	424,00\$
115919	250	6500	34750	139	400x418x100	6	1	452,00\$
115920	300	6500	40500	135	400x418x100	6	1	497,00\$
115921	400	6500	58000	145	400x418x100	6	1	618,00\$



Özellikler

Alüminyum

Temperli Cam

3000/4000/6500K

IP66

62.000h

5 Yıl



Opsiyonlar

DALI

1-10V

Step DIM

Elektriksel Sınıf I/II

Marin Boya

30° / 60° / 90° Asimetrik**

**Asimetrik Lens 180-300W arasında sunulmaktadır.

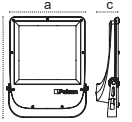
Ria IP66 Asimetrik
200-300W10kV Dahili
Parafudr

Kod	Güç (W)	Renk Sıcaklığı (K)	Işık Akısı (lm)	Etkinlik Faktörü (lm/W)	Boyutlar (mm)axbxc	Koli Ağırlığı (kg)	Koli Adedi	Fiyat
115922	200	6500	28800	144	400x418x100	6	1	424,00\$
115923	250	6500	34750	139	400x418x100	6	1	452,00\$
115924	300	6500	40500	135	400x418x100	6	1	497,00\$



Özellikler

Alüminyum

Temperli Cam

3000/4000/6500K

IP66

62.000h

5 Yıl



Opsiyonlar

DALI

1-10V

Step DIM

Elektriksel Sınıf I/II

Marin Boya

30° / 60° / 90° Asimetrik

Sterio IP66



W 50 / 450W Güç Opsiyonu

+100 lm/W

IP66 Su ve Toz Almaz

IK10 Gövde



Sterio IP66 450W

5kV Dahili Parafudr

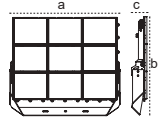

Kod	Güç (W)	Renk Sıcaklığı (K)	Işık Akısı (lm)	Etkinlik Faktörü (lm/W)	Boyutlar (mm)axbxc	Koli Ağırlığı (kg)	Koli Adedi	Fiyat
109538	450	5700	45000	100	795x390x85	11	1	506,90\$

Özellikler Alüminyum Temperli Cam 5700K IP66 30.000h

Opsiyonlar Marin Boya



Sterio IP66 300W-200W

5kV Dahili Parafudr

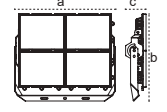

Kod	Güç (W)	Renk Sıcaklığı (K)	Işık Akısı (lm)	Etkinlik Faktörü (lm/W)	Boyutlar (mm)axbxc	Koli Ağırlığı (kg)	Koli Adedi	Fiyat
109537	300	5700	30000	100	415x540x85	8	1	382,70\$
109536	200	5700	20000	100	415x360x85	6	1	245,90\$

Özellikler Alüminyum Temperli Cam 5700K IP66 30.000h

Opsiyonlar Marin Boya



Sterio IP66 100W-50W

5kV Dahili Parafudr

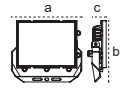

Kod	Güç (W)	Renk Sıcaklığı (K)	Işık Akısı (lm)	Etkinlik Faktörü (lm/W)	Boyutlar (mm)axbxc	Koli Ağırlığı (kg)	Koli Adedi	Fiyat
109666	100	5700	10000	100	225x365x85	10	4	105,50\$
109787	50	5700	5000	100	225x195x59	8,75	6	52,90\$

Özellikler Alüminyum Temperli Cam 5700K IP66 30.000h

Opsiyonlar Marin Boya



Franko 400W-200W

10kV Dahili Parafudr

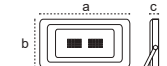

Kod	Güç (W)	Renk Sıcaklığı (K)	Işık Akısı (lm)	Etkinlik Faktörü (lm/W)	Boyutlar (mm)axbxc	Koli Ağırlığı (kg)	Koli Adedi	Fiyat
114334	400	5000	40000	100	590x316x95	12,8	1	466,60\$
114128	200	5000	19600	98	420x320x160	12,2	2	226,50\$

Özellikler Alüminyum Temperli Cam 5700K IP65 30.000h





Tartışmasız
EN İYİSİ
Lecto



Geniş PCB Alanı ile
Etkin Isı Tahliyesi



10kV Dahili Parafudr ile
Gerilim Dalgalanmalarına karşı
Güçlü Koruma



Filtre Devreleri ile Gerilim
Dalgalanmalarına karşı
Yüksek Direnç



Uzun Ömürlü

Daha fazla akım dağıtıcı
elamanı (MOSFET) ile elektronik
sürücü üzerinde **Minimum Stres,**
Maksimum Ömür.



Yeni Ürün



10kV Dahili Parafudr

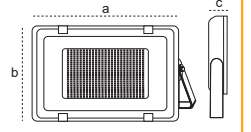

Hava Ventili
ile Nem
Yapmaz



360°
Döner
Konsol

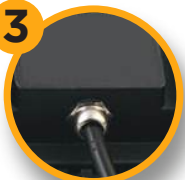

Metal
Rakor



Alüminyum
Enjeksiyon
Gövde

Lecto Max (400-500W)

LED Projektör

Kod	Güç (W)	Renk Sıcaklığı (K)	Işık Akısı (lm)	Etkinlik Faktörü (lm/W)	Boyutlar (mm)axbxc	Koli Ağırlığı (kg)	Koli Adedi	Fiyat
115485	400	5000	40000	100	550x395x60	6,7	1	343,50\$
115484	500	5000	50000	100	605x460x65	10,5	1	574,75\$

Özellikler



5kV Dahili Parafudr

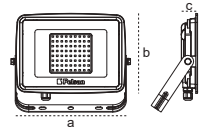

Lecto (50-300W)

LED Projektör

Kod	Güç (W)	Renk Sıcaklığı (K)	Işık Akısı (lm)	Etkinlik Faktörü (lm/W)	Boyutlar (mm)axbxc	Koli Ağırlığı (kg)	Koli Adedi	Fiyat
109304	50	5000	5000	100	245x190x33	7	6	28,10\$
109305	100	5000	10000	100	320x268x33	7,5	4	59,00\$
109306	150	5000	15000	100	348x256x33	15	6	104,20\$
111284	200	5000	19000	95	420x320x35	12	4	146,60\$
114120	300	5000	30000	100	470x335x45	17	4	224,20\$

Özellikler





Verimli monokristal panelleri ile yüksek güç çıktısı sunar. Hızlı şarj olur.



LifePO4 bataryası ile uzun ömürlüdür. Çevre sıcaklığından kolay etkilenmez. 80°C'ye kadar dayanıklıdır.



PWM kontrol devresi ile etkin şarj sağlar. BMS (Battery Managament System) devresi ile bataryayı korur.



Yüksek güçlü monokristal paneli ve batarya kapasitesi ile stabil ışık çıktısı sunar.

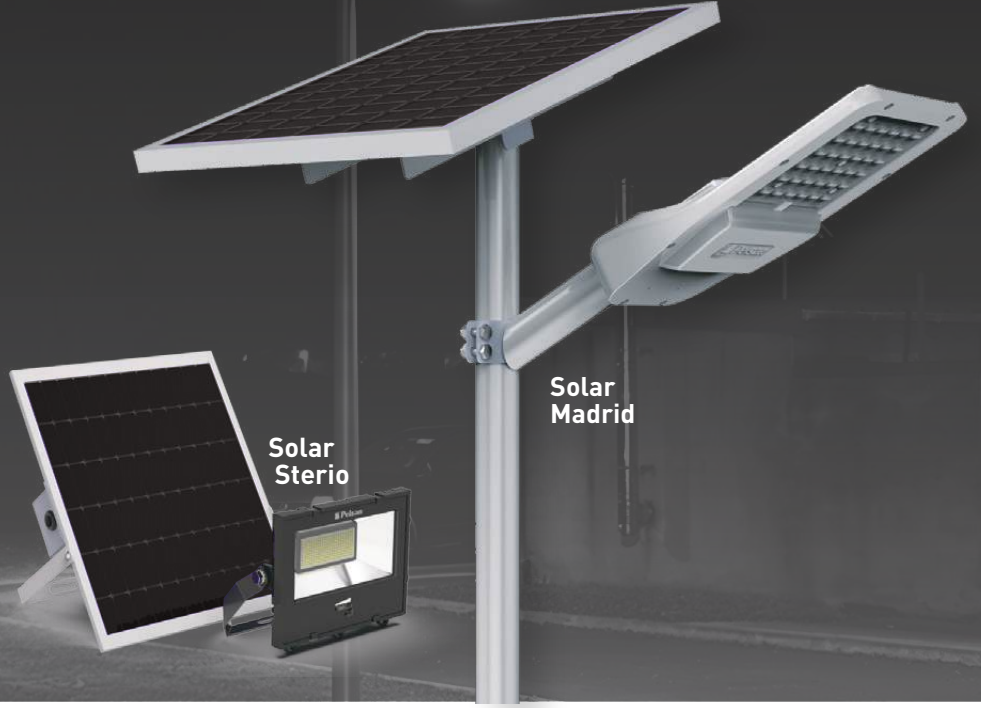

Madrid

Solar Sokak Armatürü

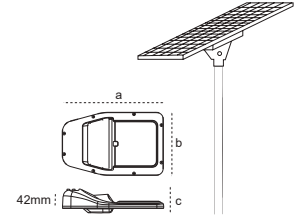

Kod	Güç (W)	Renk Sıcaklığı (K)	Işık Akısı (lm)	Solar Panel	Batarya	Otonom Süresi	Konsol Girişi	Panel Boyutu (mm)axbxc	Boyutlar (mm)axbxc	Koli Ağırlığı (kg)	Koli Adedi	Fiyat Sorunuz!
115559	140	4000	1400	25Wp	20Ah	2,5 Gün	42-60	350x452x15	324x201x75	16	1	



Özellikler



PC



PC Difüzör



3000/4000/6500K



IP65



Step DIM



Hareket Sensörü



Fotosel



Sterio

Solar Projektör

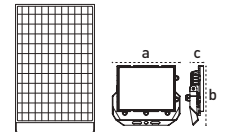

Kod	Güç (W)	Renk Sıcaklığı (K)	Işık Akısı (lm)	Solar Panel	Batarya	Otonom Süresi	Panel Boyutu	Armatür Boyutu (mm)axbxc	Koli Ağırlığı (kg)	Koli Adedi	Fiyat Sorunuz!
115558	100	6500	1000	12Wp	10Ah	1 Gün	350x290x14	225x195x59	2,86	1	



Özellikler



Alüminyum



Temperli Cam



4000/6500K



IP65



Uzaktan Kumanda



Yüksek ve stabil ışık çıktısı sunar.

Zamanla ışık çıktısı azalmaz. Accra solar HLO sıradan solar armatürlere göre MPPT teknolojisi sayesinde sürekli ve yüksek ışık çıktısı sunar.

Lenzli yapısı ile doğru ışık dağılımı

Reflektörlü ürünlere göre lensler daha doğru bir ışık dağılımı elde etmemize imkan sağlar. Doğru ışık dağılımı ile aydınlatılmak istenilen alan, verimli bir şekilde aydınlatılır.

Bakım gerektirmez LifePO4 batarya

Ternary litium bataryalara göre LifePO4 5 kata kadar uzun ömürlüdür. Çevre sıcaklığından kolay etkilenmez. 80°C'ye kadar dayanabilir.

3 gün otonom süresi

Verimli panelleri, düşük kayıplı MPPT teknolojisi ve sensör yardımı ile otonom süresi 3 güne kadar uzar.

Verimli monokristal paneller

Işık geçirgenliği yüksek monokristal panelleri ile sıradan ürünlere göre %23'e kadar daha verimlidir. Hızlı şarj olur.



Yüksek ve Stabil Işık Çıktısı

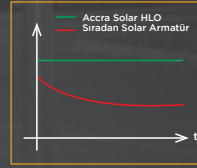

Sensör Çalışma Prensibi

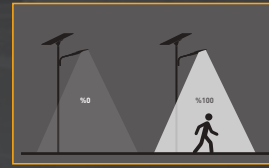

Sensör Algılama Mesafesi

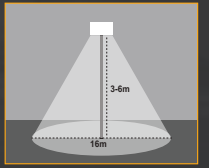

Yeni Ürün



Accra HLO

Solar Sokak Armatürü

Kod	Renk Sıcaklığı (K)	Işık Akısı (lm)	Solar Panel	Batarya	Otonom Süresi	Konsol Girişi	Boyutlar (mm)axbxc	Koli Ağırlığı (kg)	Koli Adedi	Fiyat
209010	6500	800	11Wp	12Ah	3 Gün	42-60	450x210x80	8	4	104,60\$
208644	6500	1200	11Wp	12Ah	3 Gün	42-60	450x210x80	8	4	133,20\$
209747	6500	2000	22Wp	24Ah	3 Gün	42-60	585x230x90	5	1	138,75\$
210339	6500	3000	22Wp	24Ah	3 Gün	42-60	585x230x90	5	1	168,75\$

Özellikler ABS 4000/6500K IP65 Step DIM Hareket Sensörü Fotosel

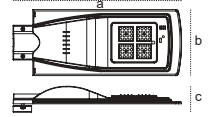

Accra

Solar Sokak Armatürü

Kod	Güç (W)	Renk Sıcaklığı (K)	Işık Akısı (lm)	Solar Panel	Batarya	Otonom Süresi	Konsol Girişi	Boyutlar (mm)axbxc	Koli Ağırlığı (kg)	Koli Adedi	Fiyat
109431	40	6500	950	8Wp	15Ah	3gün	42-60	487x236x65	21	10	83,00\$
109432	60	6500	1150	12Wp	20Ah	3gün	42-60	649x236x65	32	10	112,60\$
115222	80	6500	1260	16Wp	20Ah	3gün	42-60	730x295x65	16	4	125,70\$

Özellikler ABS 6500K IP65 50.000h Fotosel Hareket Sensörü Uzaktan Kumanda

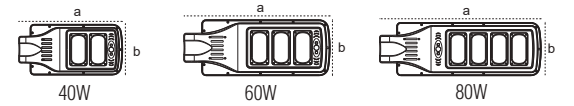

Accra

Solar Projektör

Kod	Güç (W)	Renk Sıcaklığı (K)	Işık Akısı (lm)	Solar Panel	Batarya	Otonom Süresi	Boyutlar (mm)axbxc	Koli Ağırlığı (kg)	Koli Adedi	Fiyat
114064	50	6500	335	6Wp	5Ah	-	205x158x46	1,11	1	58,20\$
114065	100	6500	820	6Wp	10Ah	-	270x225x70	2,28	1	88,80\$

Özellikler ABS Temperli Cam 6500K IP65 30.000h Fotosel Uzaktan Kumanda

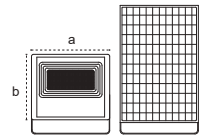

Rio XXS



- IP66, Toz ve Su Almaz Alüminyum Enjeksiyon Gövde
- IK08 Temperli Cam
- Geniş Güç Seçeneği, 35-50-60W
- IP67, ENEC Belgeli Sürücü
- LED Çip Ömrü, +100.000hrs L70 @Ts=85°C
- 10kV Dahili Parafudr
- Tool Free Tasarım



Açı ayarlanabilir konsol (0° -5° -10° -15°)



Altsiz sürücü bilmesine ulaşım imkanı



Pürüzsüz gövde tasarımı ile **kendi kendini temizler**

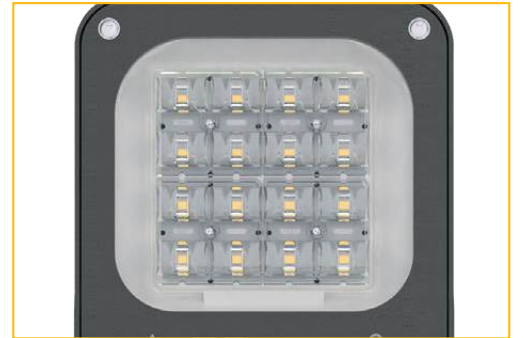

Geniş optik yüzeyi ile **en doğru ışık dağılımı**

Yeni Ürün



Rio XXS

Kod	Güç (W)	Renk Sıcaklığı (K)	Işık Akısı (lm)	Etkinlik Faktörü (lm/W)	Boyutlar (mm)axbxc	Konsol Girişi	Koli Ağırlığı (kg)	Koli Adedi	Fiyat
115610	35	4000	5075	145	178x525x120	42-60	3,3	1	170,60\$
115611	50	4000	6850	137	178x525x120	42-60	3,3	1	170,60\$
115612	60	4000	8520	142	178x525x120	42-60	3,3	1	170,60\$

Özellikler

Alüminyum

Temperli Cam

3000/4000/6500K

IP66

62.000h

Opsiyonlar

DALI

1-10V

Step DIM

Nema Soket

Zhaga Soket

Elektriksel Sınıf I/II

Marin Boya

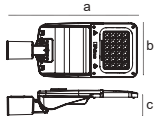



165lm/W'a
Varan Verimlilik



Rio Xs G2 IP66

10kV Dahili
Parafudr

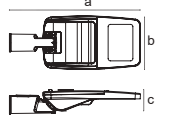

Kod	Güç (W)	Renk Sıcaklığı (K)	Işık Akısı (lm)	Etkinlik Faktörü (lm/W)	Boyutlar (mm)axbxc	Konsol Girişi	Koli Ağırlığı (kg)	Koli Adedi	Fiyat
110975	50	4000	7750	155	567x232x106	42-60	3,5	1	190,50\$
110974	60	4000	9900	165	567x232x106	42-60	3,5	1	190,50\$
110973	80	4000	11400	143	567x232x106	42-60	3,5	1	206,75\$
110972	100	4000	15000	150	567x232x106	42-60	3,5	1	206,75\$

Özellikler	Alüminyum	Temperli Cam	3000/4000/6500K	IP66	62.000h	5 Yıl	
Opsiyonlar	DALI	1-10V	Step DIM	Nema Soket	Zhaga Soket	Elektriksel Sınıf I/II	Marin Boya



163lm/W'a
Varan Verimlilik



Rio S G2 IP66

10kV Dahili
Parafudr

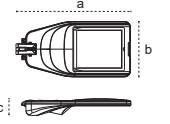

Kod	Güç (W)	Renk Sıcaklığı (K)	Işık Akısı (lm)	Etkinlik Faktörü (lm/W)	Boyutlar (mm)axbxc	Konsol Girişi	Koli Ağırlığı (kg)	Koli Adedi	Fiyat
115117	80	4000	13040	163	476x280x111	42-60	6,1	1	301,50\$
115119	100	4000	15000	150	476x280x111	42-60	6,1	1	301,50\$
115141	125	4000	18375	147	476x280x111	42-60	6,1	1	312,25\$
115142	150	4000	21450	143	476x280x111	42-60	6,1	1	312,25\$

Özellikler	Alüminyum	Temperli Cam	3000/4000/6500K	IP66	62.000h	5 Yıl	
Opsiyonlar	DALI	1-10V	Step DIM	Nema Soket	Zhaga Soket	Elektriksel Sınıf I/II	Marin Boya



160lm/W'a
Varan Verimlilik



Rio M G2 IP66

10kV Dahili
Parafudr

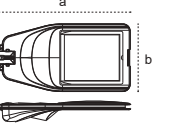

Kod	Güç (W)	Renk Sıcaklığı (K)	Işık Akısı (lm)	Etkinlik Faktörü (lm/W)	Boyutlar (mm)axbxc	Konsol Girişi	Koli Ağırlığı (kg)	Koli Adedi	Fiyat
115125	180	4000	28800	160	616x330x124	42-60	7,5	1	446,50\$
115126	200	4000	31600	158	616x330x124	42-60	7,5	1	446,50\$

Özellikler	Alüminyum	Temperli Cam	3000/4000/6500K	IP66	62.000h	5 Yıl	
Opsiyonlar	DALI	1-10V	Step DIM	Nema Soket	Zhaga Soket	Elektriksel Sınıf I/II	Marin Boya



145lm/W'a
Varan Verimlilik



Rio L IP66

10kV Dahili
Parafudr

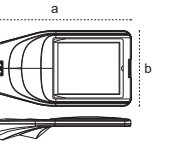

Kod	Güç (W)	Renk Sıcaklığı (K)	Işık Akısı (lm)	Etkinlik Faktörü (lm/W)	Boyutlar (mm)axbxc	Konsol Girişi	Koli Ağırlığı (kg)	Koli Adedi	Fiyat
110784	240	4000	34800	145	727x370x131	42-60	10,1	1	608,70\$
110785	270	4000	38610	143	727x370x131	42-60	10,1	1	608,70\$
110786	300	4000	42000	140	727x370x131	42-60	10,1	1	608,70\$

Özellikler	Alüminyum	Temperli Cam	3000/4000/6500K	IP66	62.000h	5 Yıl	
Opsiyonlar	DALI	1-10V	Step DIM	Nema Soket	Zhaga Soket	Elektriksel Sınıf I/II	Marin Boya



147lm/W'a
Varan Verimlilik



Doka G2 IP66

10kV Dahili Parafudr

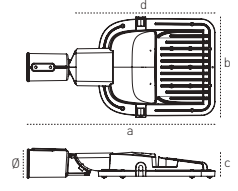

Kod	Güç (W)	Renk Sıcaklığı (K)	Işık Akısı (lm)	Etkinlik Faktörü (lm/W)	Boyutlar (mm)axbxcxd	Konsol Girişi	Koli Ağırlığı (kg)	Koli Adedi	Fiyat
115410	60	4000	8820	147	362x268x65x316	42-60	11,8	4	161,00\$
115412	80	4000	11360	142	362x268x65x316	42-60	11,8	4	172,00\$
115414	100	4000	13800	138	362x268x65x316	42-60	11,8	4	181,50\$
115416	150	4000	19050	127	362x268x65x316	42-60	11,8	4	223,50\$

Özellikler	Alüminyum	Temperli Cam	3000/4000/6500K	IP66	62.000h	5 Yıl
Opsiyonlar	DALI	1-10V	Step DIM	Elektriksel Sınıf III	Marin Boya	



Ekonomik Fiyat
4 Farklı Güç!

Berlin

6kV Dahili Parafudr

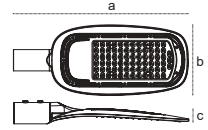

Kod	Güç (W)	Renk Sıcaklığı (K)	Işık Akısı (lm)	Etkinlik Faktörü (lm/W)	Boyutlar (mm)axbxc	Konsol Girişi	Koli Ağırlığı (kg)	Koli Adedi	Fiyat
113622	60	5000	6600	110	409x165x54	42	10	10	71,70\$
114994	80	5000	8400	105	409x165x54	42	10,2	10	101,80\$
113623	100	5000	10500	105	498x201x73	42-60	10,5	6	119,10\$
109856	150	5000	15750	105	571x248x76	42-60	13,8	6	172,20\$

Özellikler	Alüminyum	PC Difüzör	5000K	IP65	30.000h
------------	-----------	------------	-------	------	---------

Denize kıyısı bulanan bölgeler ve marinalar için özel tasarlandı.



ASLA PASLANMAZ!

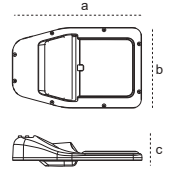

Madrid

Kod	Güç (W)	Renk Sıcaklığı (K)	Işık Akısı (lm)	Etkinlik Faktörü (lm/W)	Boyutlar (mm)axbxc	Konsol Girişi	Koli Ağırlığı (kg)	Koli Adedi	Fiyat
109841	20	4000	2760	138	324x201x75	42-48	8,7	6	62,25\$
108494	33	4000	4257	129	324x201x75	42-48	8,7	6	64,50\$
109877	40	4000	5840	146	324x201x75	42-48	8,7	6	80,00\$

Özellikler	PC	PC Difüzör	3000/4000/6500K	IP65	50.000h
------------	----	------------	-----------------	------	---------



ürün videosu



146lm/W'a
Varan Verimlilik

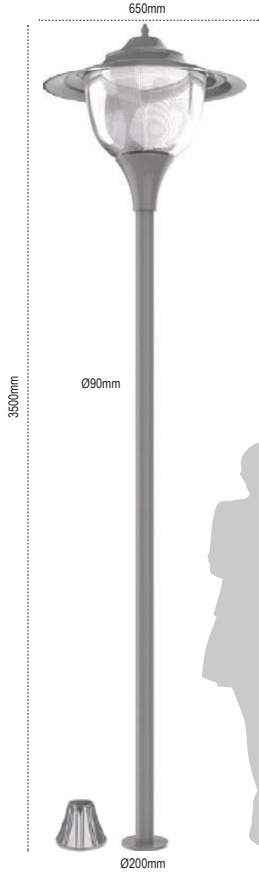



Kamaşma kontrollü özel difüzör

-  Özel prizmatik difüzör
-  Kamaşma yapmayan optik dizayn
-  Yüksek ışık geçirgenliği



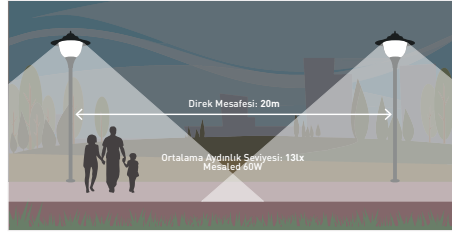



Kamaşma Önleyici Özel Difüzörü ile Görsel Konfor Sağlar

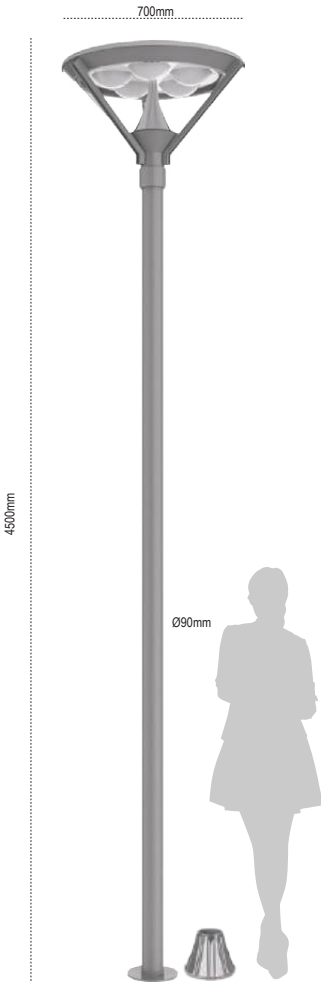

Meseled

Kod	Güç (W)	Renk Sıcaklığı (K)	Koli Adedi	Fiyat
108609	30	4000	1	364,00\$
108608	60	4000	1	400,00\$

Özellikler  IP54

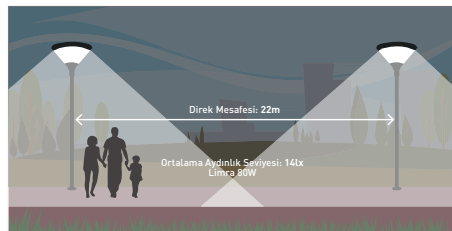

-  Alüminyum Gövde
-  Opal Difüzör
-  Alüminyum Reflektör

Limra

Kod	Güç (W)	Renk Sıcaklığı (K)	Koli Adedi	Fiyat
108606	38 (3'lü)	4000	1	631,00\$
108605	80 (5'li)	4000	1	820,00\$

Özellikler  IP54

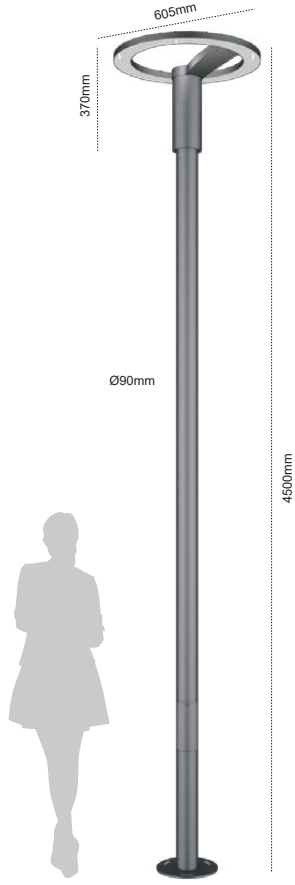

Troya Elegance

Kod	Güç (W)	Renk Sıcaklığı (K)	Koli Adedi	Fiyat
209935	30	4000	1	540,00\$
209938	40	4000	1	540,00\$
209941	50	4000	1	540,00\$
209944	60	4000	1	540,00\$

Özellikler Alüminyum Galvaniz Direk IP65

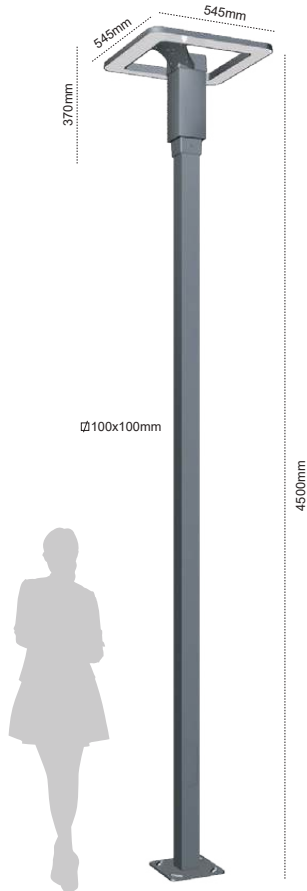

Gordion

Kod	Güç (W)	Renk Sıcaklığı (K)	Koli Adedi	Fiyat
209946	30	4000	1	685,00\$
209947	40	4000	1	685,00\$
209948	50	4000	1	685,00\$
209949	60	4000	1	685,00\$

Özellikler Alüminyum Galvaniz Direk IP65

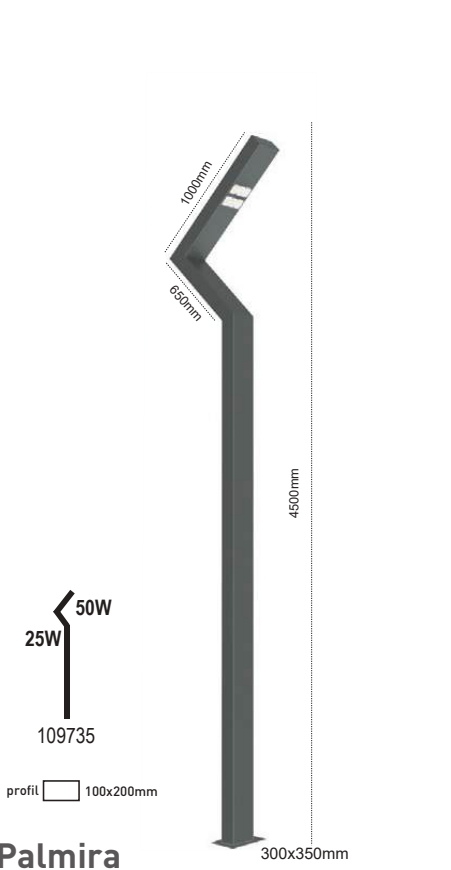

**Palmira**

Kod	Güç (W)	Renk Sıcaklığı (K)	Koli Adedi	Fiyat
109735	50+25	4000	1	1.418,00\$

Özellikler Alüminyum IP65

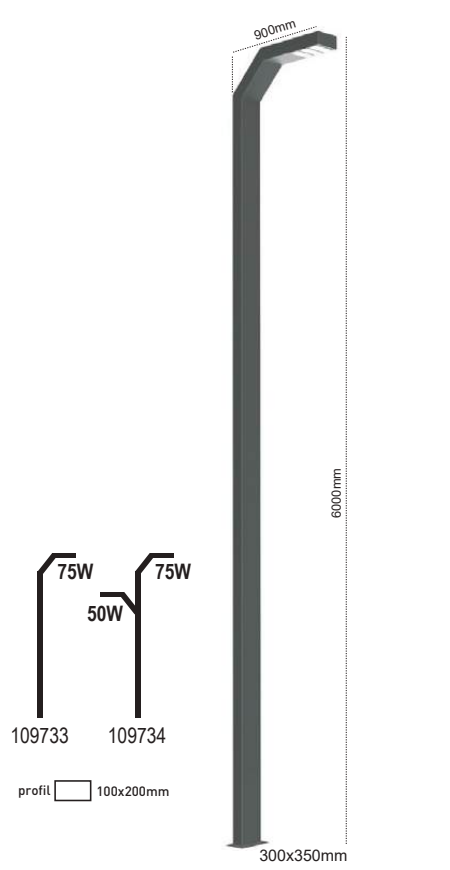

Kod	Güç (W)	Renk Sıcaklığı (K)	Koli Adedi	Fiyat
109733	75	4000	1	1.619,00\$
109734	50+75	4000	1	1.970,00\$

Özellikler Alüminyum IP65

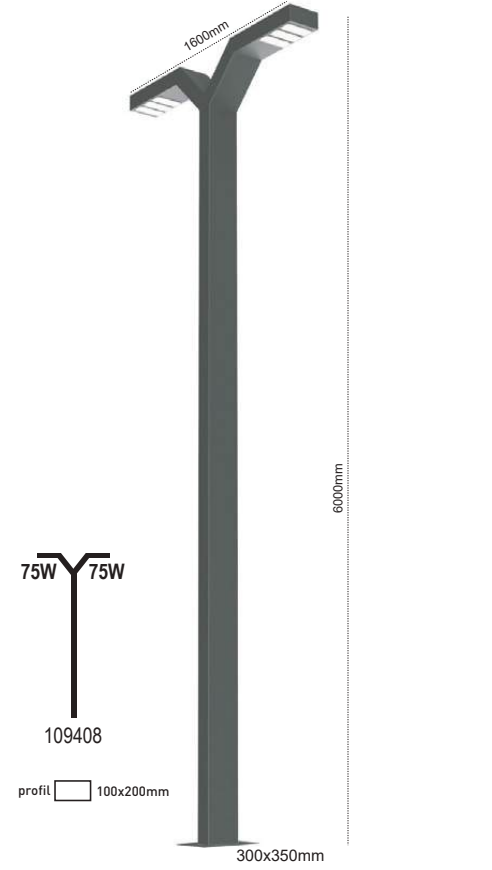

Kod	Güç (W)	Renk Sıcaklığı (K)	Koli Adedi	Fiyat
109408	75+75	4000	1	2.223,00\$

Özellikler Alüminyum IP65

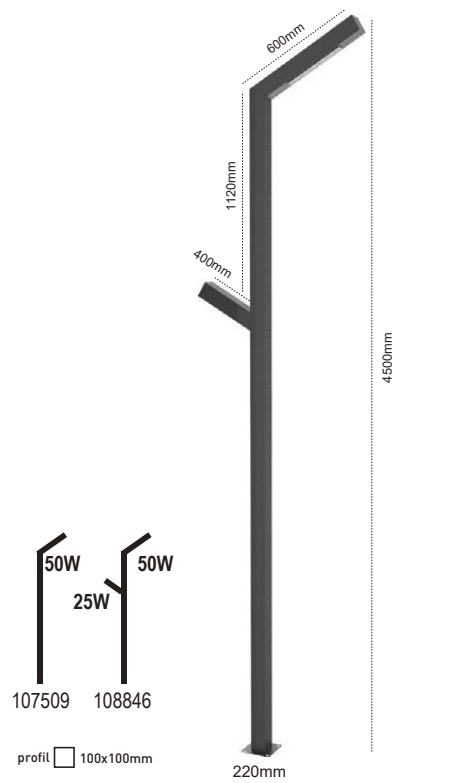
**Olimpos**

Kod	Güç (W)	Renk Sıcaklığı (K)	Koli Adedi	Fiyat
107509	50	4000	1	744,00\$
108846	50+25	4000	1	891,00\$

Özellikler Alüminyum IP65

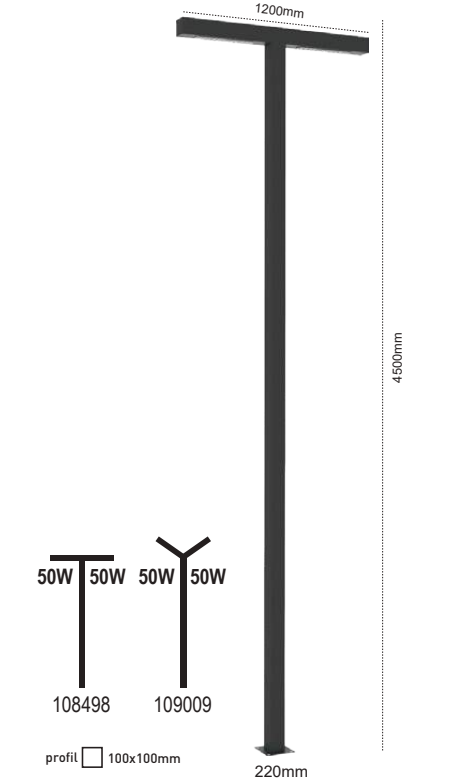

Kod	Güç (W)	Renk Sıcaklığı (K)	Koli Adedi	Fiyat
108498	50+50	4000	1	1.043,00\$

Özellikler Alüminyum IP65

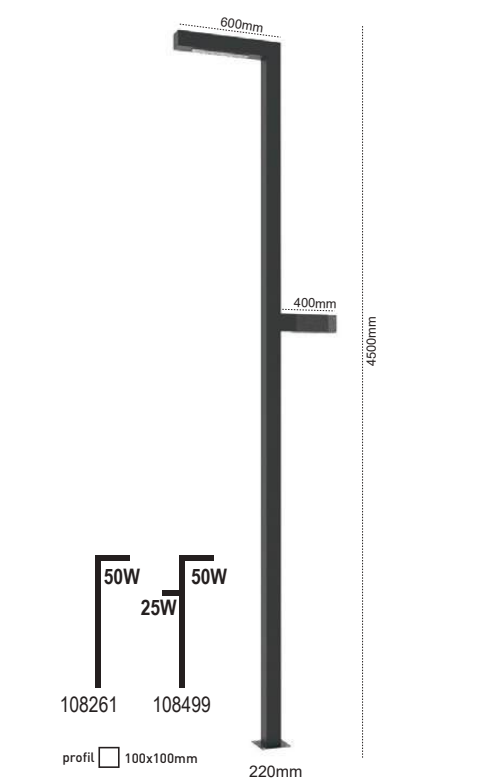

Kod	Güç (W)	Renk Sıcaklığı (K)	Koli Adedi	Fiyat
108261	50	4000	1	744,00\$
108499	50+25	4000	1	891,00\$

Özellikler Alüminyum IP65

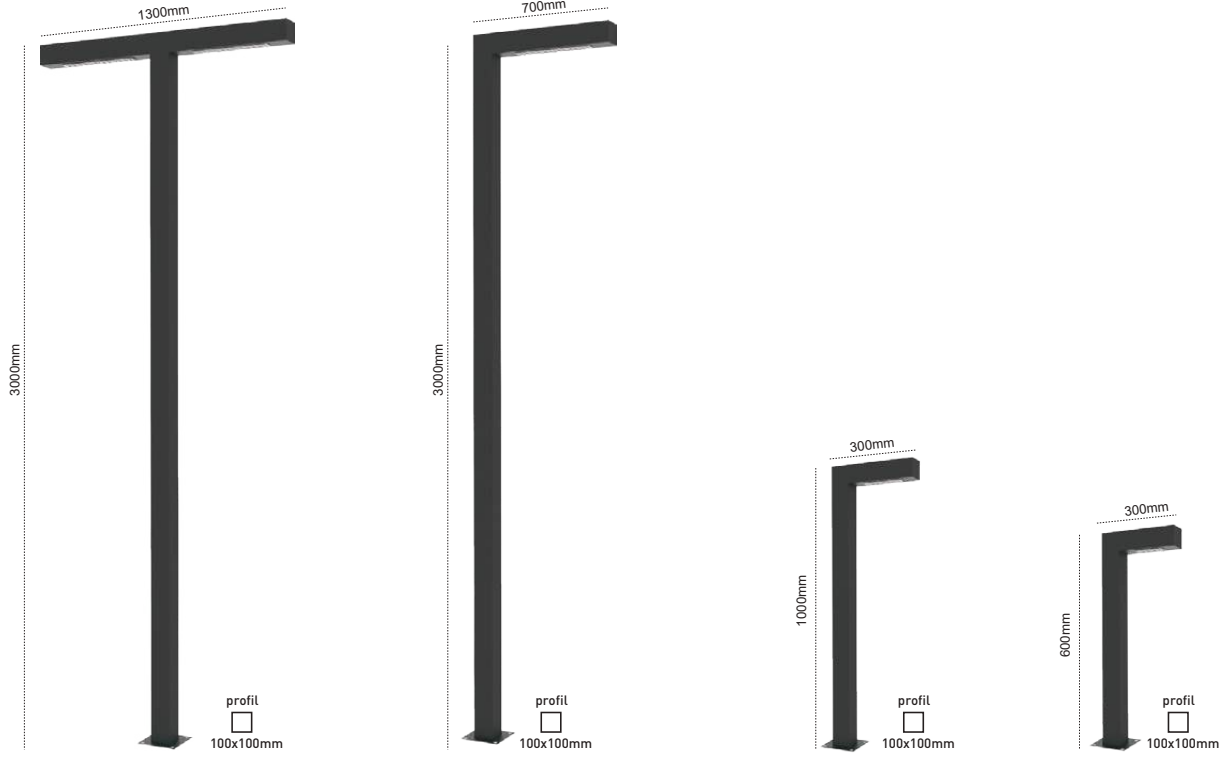

Olimpos Med

Kod	Güç (W)	Renk Sıcaklığı (K)	Boyutlar	Koli Adedi	Fiyat
206073	1x30	4000	300cm Direk	1	326,50\$
206072	2x30	4000	300cm Direk	1	402,50\$

Özellikler Alüminyum IP65

Kod	Güç (W)	Renk Sıcaklığı (K)	Boyutlar	Koli Adedi	Fiyat
206074	14	4000	60cm Bolard	1	142,50\$
206075	18	4000	100cm Bolard	1	159,50\$

Özellikler Alüminyum IP65

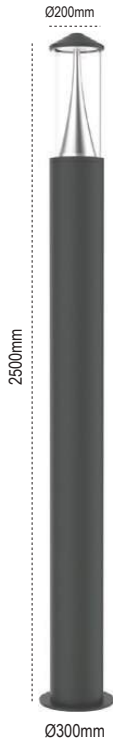

Luzon

Kod	Güç (W)	Renk Sıcaklığı (K)	Koli Adedi	Fiyat
109736	40	4000	1	625,00\$

Özellikler Alüminyum IP54

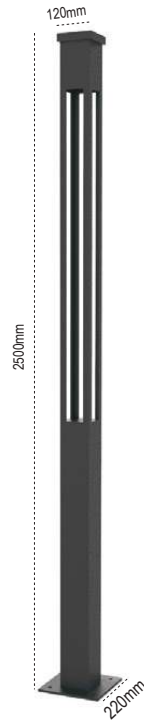

Alinda

Kod	Güç (W)	Renk Sıcaklığı (K)	Koli Adedi	Fiyat
107467	35	4000	1	387,00\$

Özellikler Alüminyum IP54

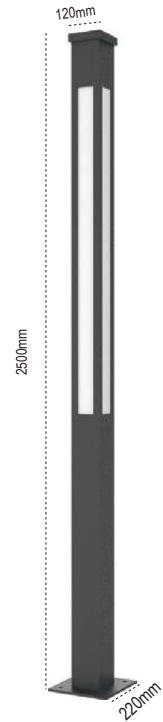

Milas

Kod	Güç (W)	Renk Sıcaklığı (K)	Koli Adedi	Fiyat
108500	100	4000	1	901,00\$

Özellikler Alüminyum IP54



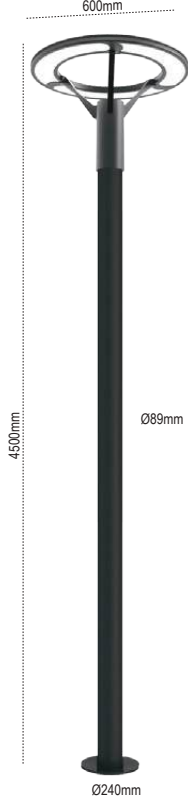

Troja G2

Kod	Güç (W)	Renk Sıcaklığı (K)	Koli Adedi	Fiyat
206776	25	4000	1	850,50\$
206780	50	4000	1	850,50\$
206783	75	4000	1	850,50\$

Özellikler  Alüminyum  Galvaniz Direk  IP65

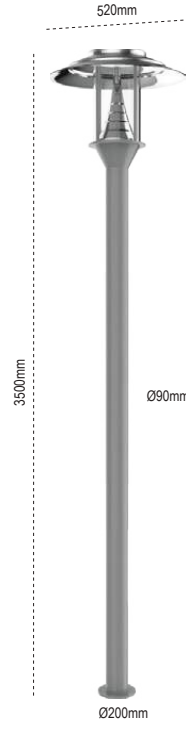

Evaled

Kod	Güç (W)	Renk Sıcaklığı (K)	Koli Adedi	Fiyat
108610	40	4000	1	706,10\$

Özellikler  IP54

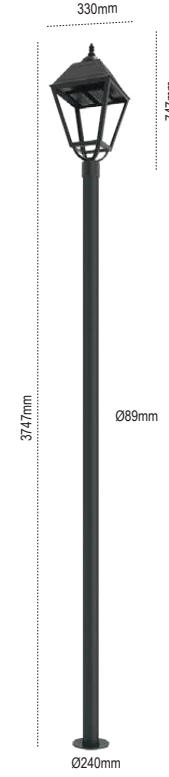

Karya

Kod	Güç (W)	Renk Sıcaklığı (K)	Koli Adedi	Fiyat
206804	25	4000	1	729,00\$
206807	50	4000	1	729,00\$
206810	75	4000	1	740,00\$

Özellikler  Alüminyum  Galvaniz Direk  IP65

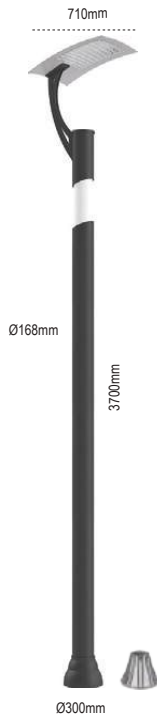

Datça

Kod	Güç (W)	Renk Sıcaklığı (K)	Koli Adedi	Fiyat
107601	30	6500	1	895,00\$

Özellikler  IP65

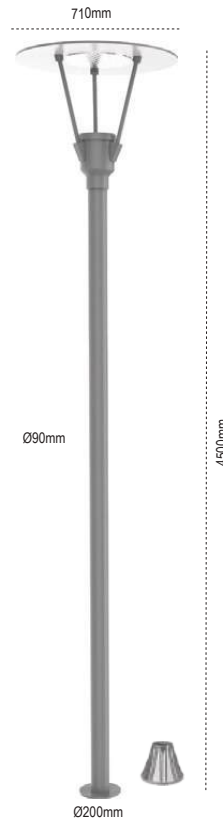

Samos

Kod	Güç (W)	Renk Sıcaklığı (K)	Koli Adedi	Fiyat
108612	150	G12	1	670,50\$
108613	50	4000	1	793,75\$

Özellikler  IP65

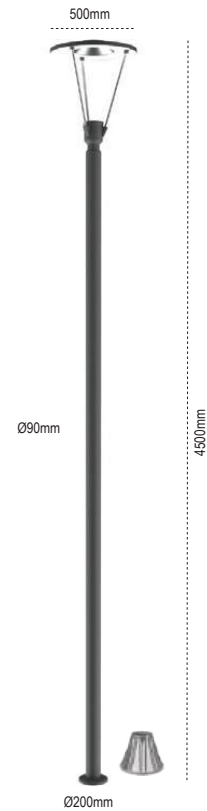

Petra

Kod	Güç (W)	Renk Sıcaklığı (K)	Koli Adedi	Fiyat
107882	50	4000	1	625,00\$

Özellikler  IP65

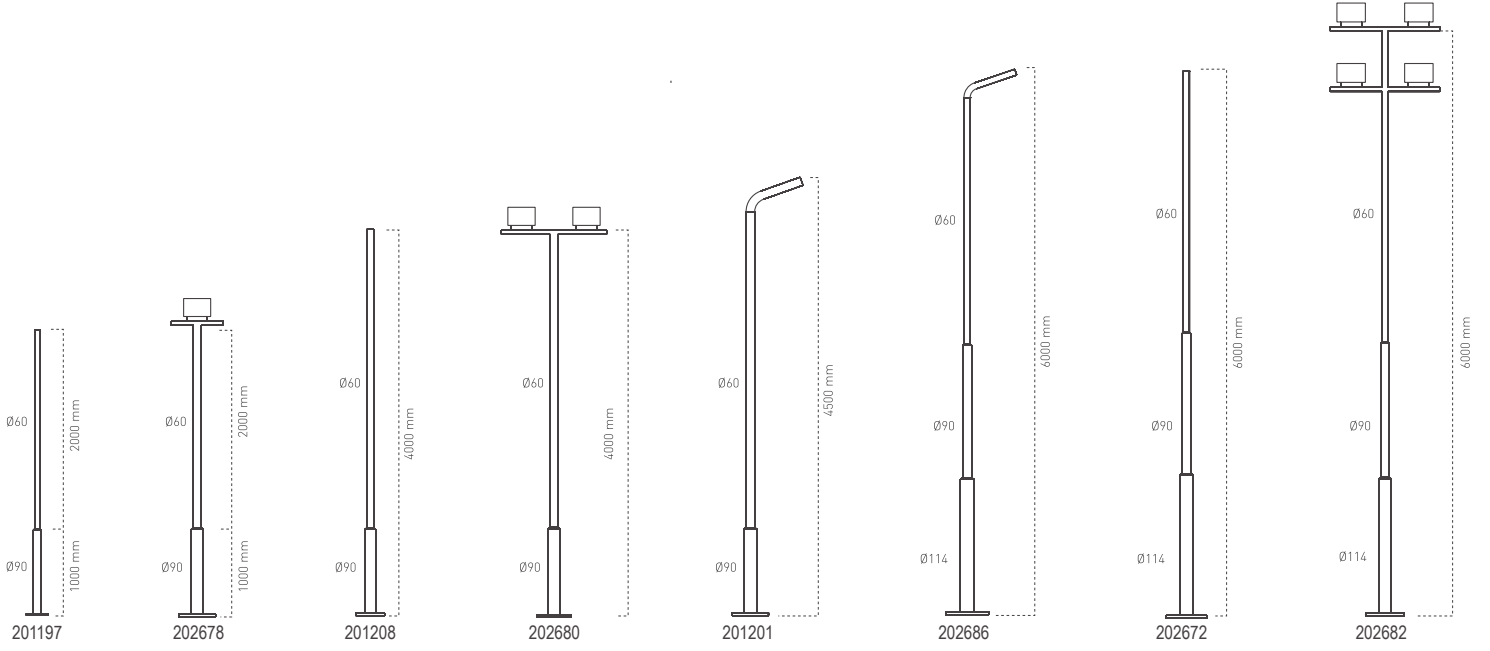

Yol, Bahçe ve Projektör Direkleri

Kod	Tanım	Koli Adedi	Fiyat
201197	3m Kademeli Boru Direk	1	166,30\$
202678	3m 1 Projektörlük Boru Direk	1	176,50\$
201208	4m Kademeli Boru Direk	1	186,70\$
202680	4m 2 Projektörlük Boru Direk	1	198,00\$

Kod	Tanım	Koli Adedi	Fiyat
201201	4,5m Sokak Lamba Direği	1	210,20\$
202686	6m Sokak Lamba Direği	1	343,90\$
202672	6m Kademeli Boru Direk	1	343,90\$
202682	6m 4 Projektörlük Direk	1	359,20\$
312688	Ankraj 250mm Polyester	1	14,30\$

Özellikler Metal IP65

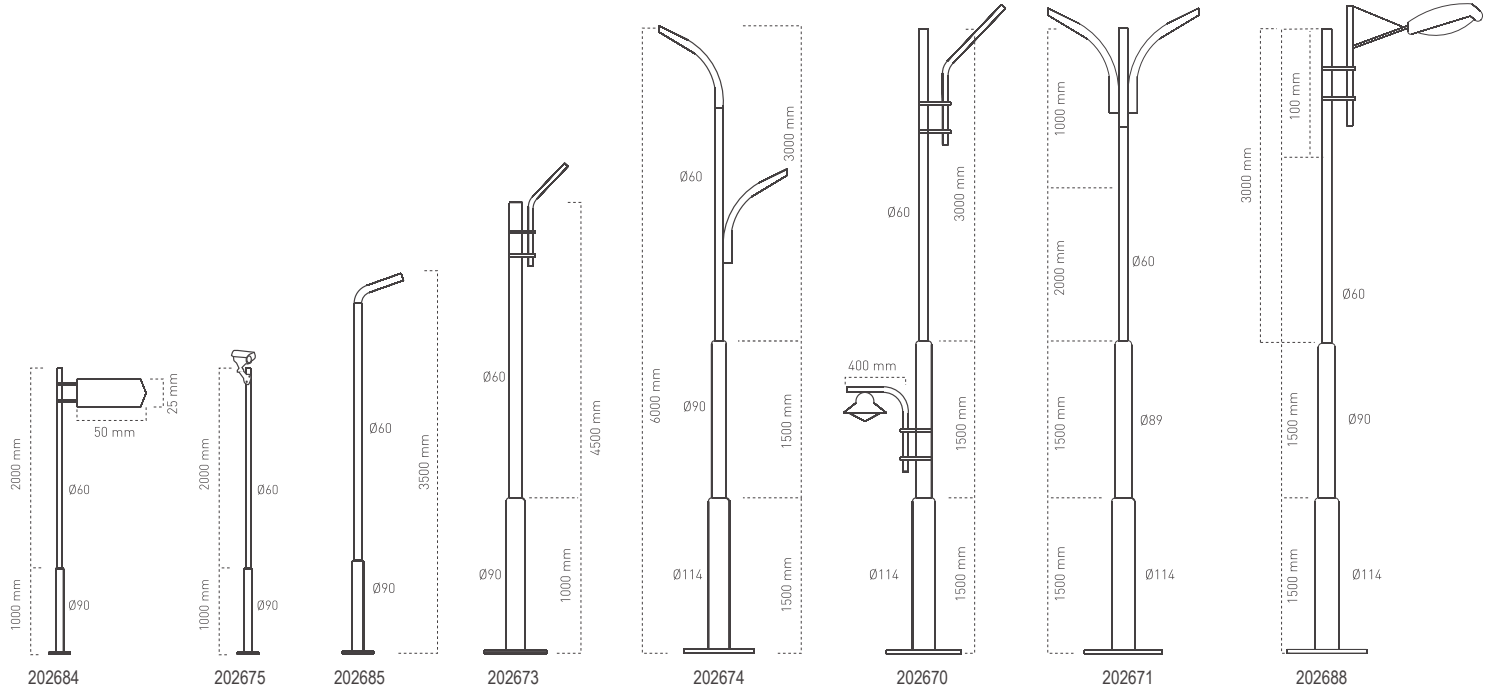

Yol, Bahçe ve Projektör Direkleri

Kod	Tanım	Koli Adedi	Fiyat
202684	3m Sokak Direği	1	190,80\$
202675	3m Kamera Direği	1	136,70\$
202685	3,5m Sokak Lamba Direği	1	190,80\$
202673	4,5m 1xArmatür Direği	1	211,20\$
312688	Ankraj 250mm Polyester	1	14,30\$

Kod	Tanım	Koli Adedi	Fiyat
202674	6m 2xArmatür Direği	1	359,20\$
202670	6m Çift Armatür Direği	1	382,70\$
202671	6m2xKonsol Direği	1	359,20\$
202668	6m Armatür Direği	1	343,90\$
312688	Ankraj 250mm Polyester	1	14,30\$

Özellikler Metal IP65



Luzon 2



IP66, Toz ve Su Almaz



Kamaşma Önleyici Optik Dizayn



Alüminyum Gövde



Opsiyonlar,

- * RAL9005, RAL7043
- * DALI
- * Marin Boya



Luzon 2

Yeni Ürün

Kod	Güç (W)	Renk Sıcaklığı (K)	Boyutlar (mm)axb	Koli Adedi	Fiyat
115479	14	4000	655x120x120	1	185,00\$

Özellikler



Alüminyum



IP66



Alberi

Yeni Ürün

Kod	Güç (W)	Renk Sıcaklığı (K)	Boyutlar (mm)axbxc	Koli Adedi	Fiyat
208553	6	3000	250x100x100	1	56,10 \$
208554	6	3000	500x100x100	1	65,30 \$
208555	6	3000	700x100x100	1	70,40 \$

Özellikler Alüminyum IP54



Belise

Yeni Ürün

Kod	Güç (W)	Renk Sıcaklığı (K)	Boyutlar (mm)axb	Koli Adedi	Fiyat
208529	6	3000	250x100	1	56,10 \$
208530	6	3000	500x100	1	65,30 \$
208531	6	3000	750x100	1	70,40 \$

Özellikler Alüminyum IP54



Ayers

Yeni Ürün

Kod	Güç (W)	Renk Sıcaklığı (K)	Boyutlar (mm)axb	Koli Adedi	Fiyat
208541	6	3000	200x75x70	1	71,40 \$
208542	6	3000	500x75x70	1	80,60 \$
208543	6	3000	800x75x70	1	88,70 \$

Özellikler Alüminyum IP54

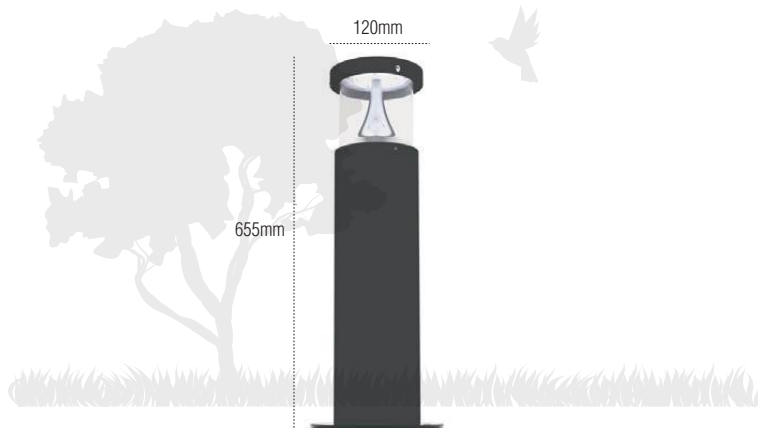

Luzon 2

Kod	Güç (W)	Renk Sıcaklığı (K)	Boyutlar (mm)axb	Koli Adedi	Fiyat
110753	10	4000	655x120	1	120,00\$

Özellikler Alüminyum IP54



**Bali**

Kod	Güç (W)	Renk Sıcaklığı (K)	Koli Adedi	Fiyat
108870	18	4000	1	170,00\$

Özellikler  Alüminyum  IP65

Malta

Kod	Güç (W)	Renk Sıcaklığı (K)	Koli Adedi	Fiyat
108871	2x18	4000	1	270,00\$

Özellikler  Alüminyum  IP65

Maldiv

Kod	Güç (W)	Renk Sıcaklığı (K)	Koli Adedi	Fiyat
108872	18	4000	1	170,00\$

Özellikler  Alüminyum  IP65

Santorini

Kod	Güç (W)	Renk Sıcaklığı (K)	Koli Adedi	Fiyat
108873	2x18	4000	1	270,00\$

Özellikler  Alüminyum  IP65

**Pega**

Kod	Güç (W)	Renk Sıcaklığı (K)	Koli Adedi	Fiyat
108878	18	4000	1	178,00\$

Özellikler  Alüminyum  IP65

Mayorka

Kod	Güç (W)	Renk Sıcaklığı (K)	Koli Adedi	Fiyat
111419	18	4000	1	245,90\$

Özellikler  Alüminyum  IP65

Alinda

Kod	Güç (W)	Renk Sıcaklığı (K)	Koli Adedi	Fiyat
108859	18	4000	1	197,00\$

Özellikler  Alüminyum  IP65

Luzon

Kod	Güç (W)	Renk Sıcaklığı (K)	Koli Adedi	Fiyat
109027	20	4000	1	224,50\$

Özellikler  Alüminyum  IP54

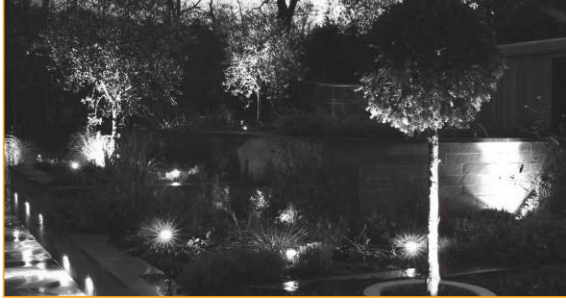

Santa

Çimen / Bahçe Armatürü

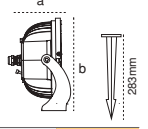

Kod	Güç (W)	Renk Sıcaklığı (K)	Boyutlar (mm)axb	Koli Adedi	Fiyat
206767	15	4000	101x185	1	148,00\$
206768	15	6500	101x185	1	148,00\$
206770	25	4000	101x185	1	148,00\$
206771	25	6500	101x185	1	148,00\$
206773	37	4000	101x185	1	164,70\$
206774	37	6500	101x185	1	164,70\$

Özellikler Alüminyum IP65



Grased

Çimen / Bahçe Armatürü

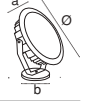

Kod	Güç (W)	Renk Sıcaklığı (K)	Boyutlar (mm)axb	Koli Adedi	Fiyat
209920	3	4000	110x75x75	1	38,80 \$
209921	3	6500	110x75x75	1	38,80 \$
209923	6	4000	150x122x1100	1	67,50 \$
209924	6	6500	150x122x1100	1	67,50 \$
209926	9	4000	150x122x1100	1	77,55 \$
209927	9	6500	150x122x1100	1	77,55 \$

Özellikler Alüminyum IP65



Alinda

Set Üstü Armatür

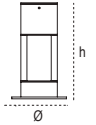

Kod	Güç (W)	Renk Sıcaklığı (K)	Boyutlar (mm)øxh	Koli Adedi	Fiyat
109401	15	4000	200x310	8	125,50\$

Özellikler Alüminyum IP65



Pega

Set Üstü Armatür

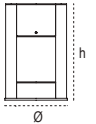

Kod	Güç (W)	Renk Sıcaklığı (K)	Boyutlar (mm)øxh	Koli Adedi	Fiyat
109403	15	4000	200x310	2	125,50\$

Özellikler Alüminyum IP65



Tino

Set Üstü Armatür

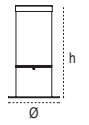

Kod	Duy	Renk Sıcaklığı (K)	Boyutlar (mm)øxh	Koli Adedi	Fiyat
110709	E27	-	170x310	8	65,50\$

Özellikler Alüminyum IP54



**Carla****Yeni Ürün**

Kod	Güç (W)	Renk Sıcaklığı (K)	Boyutlar (mm)axbxc	Koli Adedi	Fiyat
207106	2xGu10	-	150x93x70	1	39,50 \$

Özellikler  Alüminyum  IP44

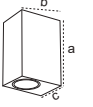
**Vasco****Yeni Ürün**

Kod	Güç (W)	Renk Sıcaklığı (K)	Boyutlar (mm)axbxc	Koli Adedi	Fiyat
207108	2x4	3000	162x90x58	1	39,50 \$

Özellikler  Alüminyum  IP44

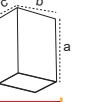
**Santos****Yeni Ürün**

Kod	Güç (W)	Renk Sıcaklığı (K)	Boyutlar (mm)axbxc	Koli Adedi	Fiyat
207110	2x3	3000	176x111x62	1	39,50 \$

Özellikler  Alüminyum  IP44

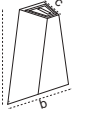
**Dura****Yeni Ürün**

Kod	Güç (W)	Renk Sıcaklığı (K)	Boyutlar (mm)axb	Koli Adedi	Fiyat
208145	2x4	3000	160x90x58	1	39,50 \$

Özellikler  Alüminyum  IP44

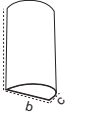
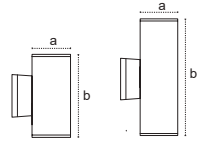
**Işılray1 / Işılray2**

Kod	Duy	Renk Sıcaklığı (K)	Boyutlar (mm)axh	Koli Adedi	Fiyat
110742	E27	-	120x180	8	47,50\$
110743	2xE27	-	120x300	6	59,50\$

Özellikler  Alüminyum  IP44

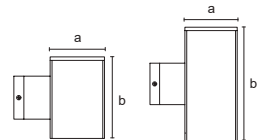
**Tibat1 / Tibat2**

Kod	Duy	Renk Sıcaklığı (K)	Boyutlar (mm)axh	Koli Adedi	Fiyat
110744	E27	-	120x180	8	49,50\$
110745	2xE27	-	120x305	6	61,50\$

Özellikler  Alüminyum  IP44



Mova (Sensörlü)

Kod	Güç (W)	Renk Sıcaklığı (K)	Boyutlar (mm)øxh	Koli Adedi	Fiyat
109228	10	4000	255x185	20	29,10 \$

Özellikler  PC  IP54

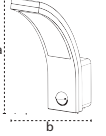

110324 (Sensörlü)

111603

Mova

Kod	Güç (W)	Renk Sıcaklığı (K)	Boyutlar (mm)øxh	Koli Adedi	Fiyat
110324	10	4000	255x185	20	29,10 \$
111603	10	4000	255x185	20	21,65 \$

Özellikler  PC  IP54

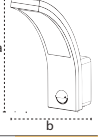

Ferra (Sensörlü)

Kod	Güç (W)	Renk Sıcaklığı (K)	Boyutlar (mm)øxh	Koli Adedi	Fiyat
113599	20	4000	244x100	10	47,95 \$

Özellikler  PC  IP65

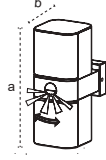

Tilva (Sensörlü)

Kod	Güç (W)	Renk Sıcaklığı (K)	Boyutlar (mm)øxh	Koli Adedi	Fiyat
113596	20	4000	250x80	20	47,95 \$

Özellikler  PC  IP65

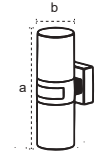

Grada (Sensörlü)

Kod	Güç (W)	Renk Sıcaklığı (K)	Boyutlar (mm)axb	Koli Adedi	Fiyat
113600	2x10	4000	156,3x75	8	50,50 \$

Özellikler  Alüminyum  IP65

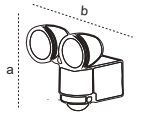

ATEX Belgeleri

ATEX Belgeli Pelsan Exproof armatürler, tehlikeli gaz ve toz maddelerinin bulunduğu, patlama riski olan ortamlarda güvenle kullanılabilir.

Zone2, Zone22



ATEX
LARGO EX-PROOF



ATEX
ELIT LIRAD EX-PROOF



ATEX
AUSLED-RAUSLED
EX-PROOF



ATEX
SIA/NAIRO/PIROLIZ
EX-PROOF

Zone1, Zone21



ATEX
ATAREX YÜKSEK TAVAN
EX-PROOF



ATEX
ATAREX PROJİKTÖR
EX-PROOF



ATEX
EXTA EX-PROOF

TSE Belgeleri

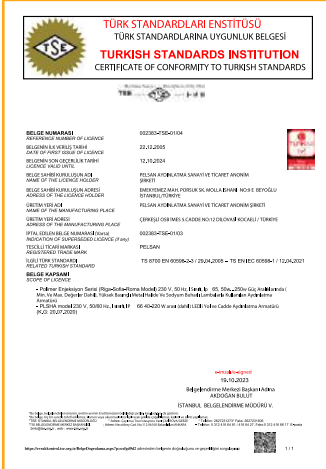

Yol ve Cade Armatürleri



Projektörler



Genel Amaçlı Sabit Armatürler

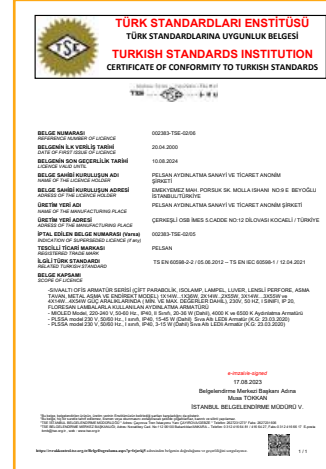

Sıva Altı Armatürler

ENEC Belgeleri



Projektörler



Projektörler



Yol ve Cade Armatürleri



EAC Belgeleri



Ofis Armatürler



Downlight

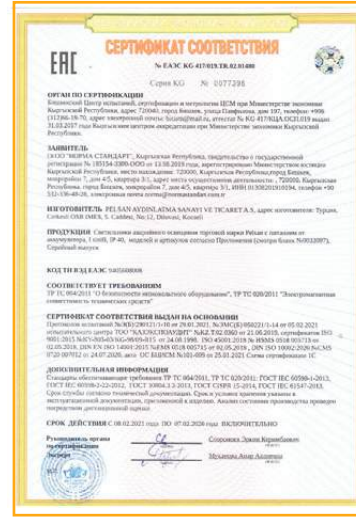

Acil Aydınlatma Armatürleri



Acil Aydınlatma ve Yönlendirme Armatürler



Etanj Armatürler

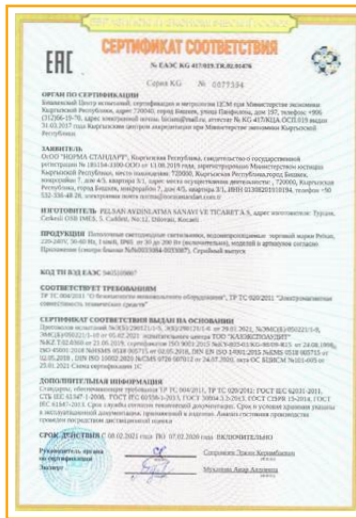

Yüksek Tavan Armatürler



Projektörler



Yol ve Cade Armatürleri

Lined area for notes, consisting of horizontal lines.



yatırımlarla büyüyoruz!



Enerji İhtiyacımızı
"Solar Çatı Güneş Enerji Sistemi" ile
Sağlıyoruz!



1100 kW
Kurulu Güç



CO₂



 **Pelsan**

www.pelsan.com.tr

  /pelsanaydinlatma

  @pelsanaydinlatma

 @pelsanlight

yatırımlarla büyüyoruz!

Alüminyum Enjeksiyon Makinesi Yatırımı ile

Tüm alüminyum enjeksiyon
gövdeli ürünlerimizi **kendi**
tesisimizde üretiyoruz.



 **Pelsan**

www.pelsan.com.tr

  /pelsanaydinlatma

  @pelsanaydinlatma

 @pelsanlight

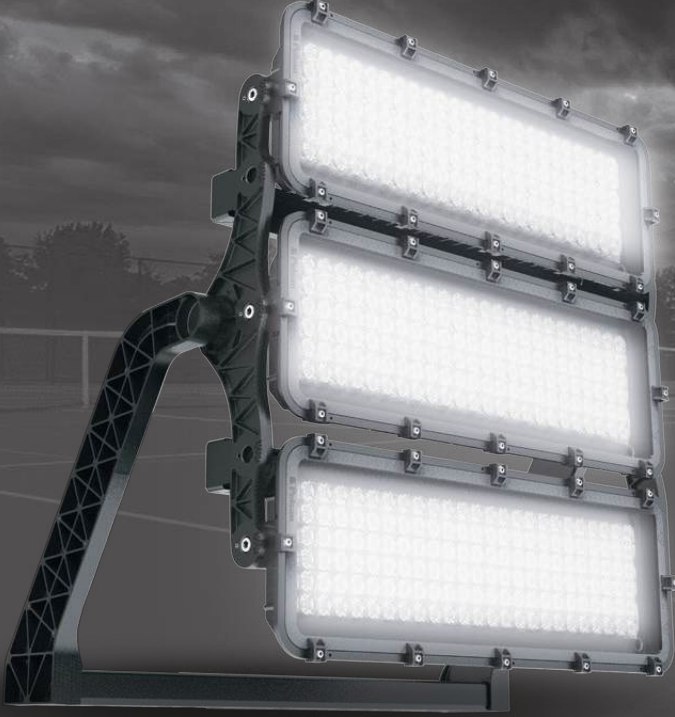

- W** 300-1800W
- 🕒** 100.000h Driver Ömrü
- ⚡** 10kV Dahili Parafudr
- 🔨** IK10 Gövde
- ☔** IP66, Toz ve Su Almaz!
- ⚡** Gerilim Dalgalanmalarından Etkilenmez
100-277Vac



**Yüksek Güçlü
LED Projektörler Sayfa 48**

Lens Opsiyonları



Güncel ürün bilgisi ve belgeleri için www.pelsan.com.tr' yi ziyaret ediniz.

www.pelsan.com.tr

info@pelsan.com.tr | export@pelsan.com.tr

